

10W isolated DC-DC converter in DIP package
Ultra-wide input and regulated single/dual output



FEATURES

- Ultra-wide 4:1 input voltage range
- High efficiency up to 87%
- No-load power consumption as low as 0.12W
- I/O isolation test voltage: 3k VDC
- Input under-voltage protection, output short-circuit, over-voltage, over-current protection
- Operating ambient temperature range: -40°C to +85°C
- Meets CISPR32/EN55032 CLASS A, without extra components
- Input reverse polarity protection available with Chassis (A2S) or 35mm Din-Rail mounting (A4S) version
- IEC60950, UL60950, EN60950 approved
- Meets EN62368 standard
- Industry standard pin-out

URE_LP-10WR3 & URF_LP-10WR3 series of isolated 10W DC-DC converter products with an ultra-wide 4:1 input voltage range and feature efficiencies of up to 87%, input to output isolation is tested with 3000VDC and the converters safely operate in an ambient temperature of -40°C to +85°C, input under-voltage protection, output short-circuit, over-current and over-voltage protection. They meet CLASS A of CISPR32/EN55032 EMI standards without external components, optional packages A2S and A4S also offer the added feature of input reverse polarity protection and they are widely used in applications for industrial control, electric power, instruments and communication fields.

Selection Guide

Certification	Part No. ①	Input Voltage (VDC)		Output		Full Load Efficiency ③ (%) Min./Typ.	Capacitive Load (μF) ⑤ Max.
		Nominal ② (Range)	Max. ④	Voltage (VDC)	Current (mA) Max./Min.		
UL/CE/CB	URE2405LP-10WR3	24 (9-36)	40	±5	±1000/0	79/81	1000
	URE2412LP-10WR3			±12	±416/0	83/85	330
	URE2415LP-10WR3			±15	±333/0	85/87	220
	URF2403LP-10WR3			3.3	2400/0	76/78	5400
	URF2405LP-10WR3			5	2000/0	80/82	5400
	URF2409LP-10WR3			9	1111/0	82/84	680
	URF2412LP-10WR3			12	833/0	82/84	470
	URF2415LP-10WR3			15	667/0	85/87	330
	URF2424LP-10WR3			24	416/0	84/86	100
	URE4805LP-10WR3			±5	±1000/0	80/82	1000
URE4812LP-10WR3	±12	±416/0	84/86	330			
URE4815LP-10WR3	±15	±333/0	85/87	220			
UL/CE	URF4803LP-10WR3	48 (18-75)	80	3.3	2400/0	77/79	5400
	URF4805LP-10WR3			5	2000/0	80/82	5400
	URF4812LP-10WR3			12	833/0	84/86	470
	URF4815LP-10WR3			15	667/0	85/87	330
	URF4824LP-10WR3			24	416/0	85/87	100

Notes:
 ① Use "A2S" suffix for chassis mounting and "A4S" suffix for Din-Rail mounting;
 ② Minimum input voltage and start-up voltage are increased by 1VDC for all models with A2S and A4S suffixes because of the input reverse polarity function;
 ③ Exceeding the maximum input voltage may cause permanent damage;
 ④ Efficiency is measured at nominal input voltage and rated output load; efficiencies for A2S and A4S Model's is decreased by 2% due to the input reverse polarity protection circuit;
 ⑤ The specified maximum capacitive load value for Vo1 and Vo2 output is identical.

Input Specifications

Item	Operating Conditions	Min.	Typ.	Max.	Unit	
Input Current (full load / no-load)	24VDC nominal input series, nominal input voltage	3.3VDC output	--	423/5	434/12	mA
		Others	--	514/5	527/12	
	48VDC nominal input series, nominal input voltage	3.3VDC output	--	208/5	214/12	
		Others	--	254/5	260/12	
Reflected Ripple Current	24VDC nominal input series, nominal input voltage	--	40	--		
	48VDC nominal input series, nominal input voltage	--	30	--		
Surge Voltage (1sec. max.)	24VDC nominal input series	-0.7	--	50		
	48VDC nominal input series	-0.7	--	100		
Start-up Voltage	24VDC nominal input series	--	--	9	VDC	
	48VDC nominal input series	--	--	18		
Input Under-voltage Protection	24VDC nominal input series	5.5	6.5	--		
	48VDC nominal input series	12	15.5	--		
Start-up Time	Nominal input voltage & constant resistance load	--	10	--	ms	
Input Filter		PI filter				
Hot Plug		Unavailable				
Ctrl*	Module on	Ctrl pin open or pulled high (3.5-12VDC)				
	Module off	Ctrl pin pulled low to GND (0-1.2VDC)				
	Input current when off	--	5	10	mA	

Note: * The Ctrl pin voltage is referenced to input GND.

Output Specifications

Item	Operating Conditions	Min.	Typ.	Max.	Unit	
Voltage Accuracy ^①	0% - 100% load	--	±1	±3	%	
Linear Regulation	Input voltage variation from low to high at full load	Vo1	--	±0.2		±0.5
		Vo2	--	±0.5		±1.0
Load Regulation ^②	5% - 100% load	Vo1	--	±0.5		±1
		Vo2	--	±0.5	±1.5	
Cross Regulation	Dual outputs, Vo1 load at 50%, Vo2 load at range of 10% - 100%	--	--	±5		
Transient Recovery Time	25% load step change, nominal input voltage	--	300	500	μs	
Transient Response Deviation		--	±3	±5	%	
Temperature Coefficient	Full load	--	--	±0.03	%/°C	
Ripple & Noise ^③	20MHz bandwidth, 5% - 100% load	--	60	120	mV p-p	
Over-voltage Protection	Input voltage range	110	130	160	%Vo	
Over-current Protection		110	140	190	%Io	
Short-circuit Protection		Continuous, self-recovery				

Note:
 ① Output voltage accuracy of ±5VDC output for 0% - 5% load is ±5% max;
 ② Load regulation for 0% - 100% load increases to ±5%;
 ③ Ripple & Noise at ≤ 5% load is 5%Vo max. The "parallel cable" method is used for Ripple and Noise test, please refer to DC-DC Converter Application Notes for specific information.

General Specifications

Item	Operating Conditions	Min.	Typ.	Max.	Unit
Isolation	Input-output Electric Strength Test for 1 minute with a leakage current of 1mA max.	3000	--	--	VDC
Insulation Resistance	Input-output resistance at 500VDC	1000	--	--	MΩ
Isolation Capacitance	Input-output capacitance at 100KHz/0.1V	--	500	--	pF
Operating Temperature	See Fig. 1	-40	--	+85	°C
Storage Temperature		-55	--	+125	°C

Storage Humidity	Non-condensing	5	--	95	%RH
Pin Soldering Resistance Temperature	Soldering spot is 1.5mm away from case for 10 seconds	--	--	+300	°C
Vibration		10-55Hz, 2G, 30 Min. along X, Y and Z			
Switching Frequency*	PWM mode	--	350	--	KHz
MTBF	MIL-HDBK-217F@25°C	1000	--	--	K hours

Note:* Switching frequency is measured at full load. The module reduces the switching frequency for light load (below 50%) efficiency improvement.

Mechanical Specifications

Case Material	Black flame-retardant and heat-resistant plastic (UL94 V-0)				
Dimensions	Horizontal package	51.50 x 26.50 x 12.00 mm			
	A2S chassis mounting	76.00 x 31.50 x 21.20 mm			
	A4S Din-rail mounting	76.00 x 31.50 x 25.80 mm			
Weight	Horizontal package/A2S chassis mounting/A4S Din-rail mounting	21.2g/46.0g/66.0g (Typ.)			
Cooling method	Free air convection				

Electromagnetic Compatibility (EMC)

Emissions	CE	CISPR32/EN55032	CLASS A (without extra components)/ CLASS B (see Fig. 3-② for recommended circuit)	
	RE	CISPR32/EN55032	CLASS A (without extra components)/ CLASS B (see Fig. 3-② for recommended circuit)	
Immunity	ESD	IEC/EN61000-4-2	Contact ±4KV	perf. Criteria B
	RS	IEC/EN61000-4-3	10V/m	perf. Criteria A
	EFT	IEC/EN61000-4-4	±2KV (see Fig. 3-① for recommended circuit)	perf. Criteria B
	Surge	IEC/EN61000-4-5	line to line ±2KV (see Fig. 3-① for recommended circuit)	perf. Criteria B
	CS	IEC/EN61000-4-6	3 Vr.m.s	perf. Criteria A
	Voltage dips, short interruptions and voltage variations immunity	IEC/EN61000-4-29	0%, 70%	perf. Criteria B

Typical Characteristic Curves

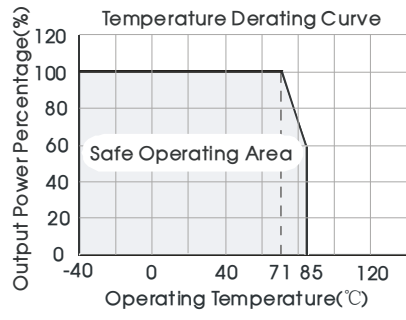
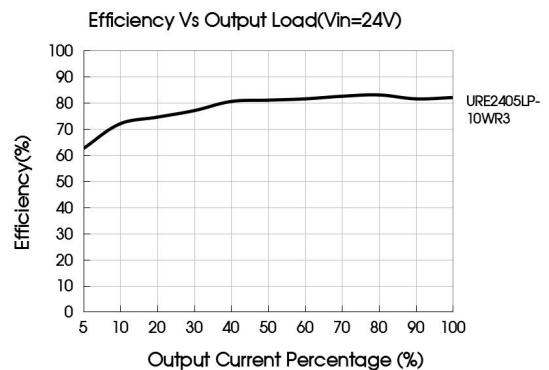
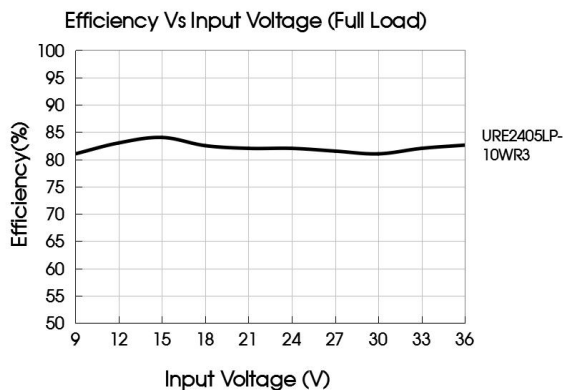
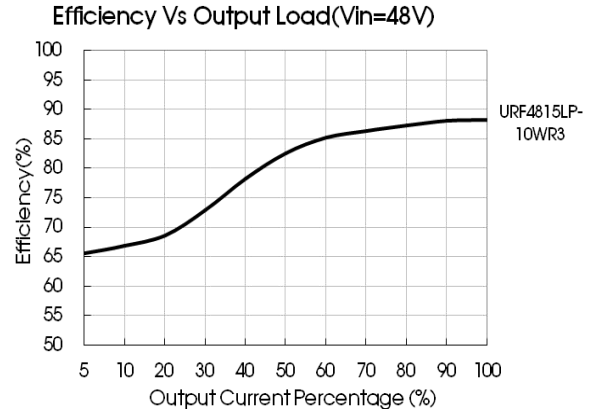
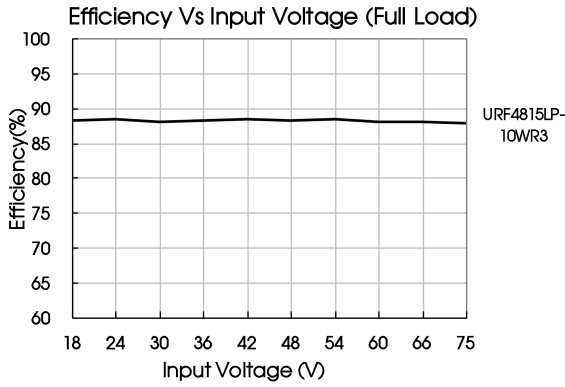

Fig. 1





Design Reference

1. Typical application

All DC-DC converters of this series are tested before delivery using the recommended circuit shown in Fig. 2.

Input and/or output ripple can be further reduced by appropriately increasing the input & output capacitor values C_{in} and C_{out} and/or by selecting capacitors with a low ESR (equivalent series resistance). Also make sure that the capacitance is not exceeding the max. capacitive load value of the product.

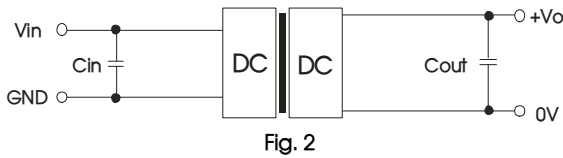

C_{in}	C_{out}
10 μ F - 47 μ F/100V	10 μ F/63V

2. EMC compliance circuit

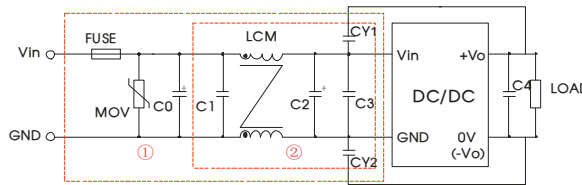

Notes: For EMC tests we use Part ① in Fig. 3 for immunity and part ② for emissions test. Selecting based on needs.

List of components:

Model	URE_LP-10WR3		URF_LP-10WR3	
	Vin:24V	Vin:48V	Vin:24V	Vin:48V
FUSE	Choose according to actual input current			
MOV	S20K30	S14K60	S20K30	S14K60
C0	680 μ F/50V	680 μ F/100V	680 μ F/50V	680 μ F/100V
C1	1 μ F/50V	1 μ F/100V	1 μ F/50V	1 μ F/100V
C2	330 μ F/50V	330 μ F/100V	330 μ F/50V	330 μ F/100V
C3	4.7 μ F/50V	4.7 μ F/100V	4.7 μ F/50V	4.7 μ F/100V
LCM	4.7mH, recommended to use MORNSUN's FL2D-30-472			6.8mH
C4	Refer to the C_{out} in Fig.2			
CY1/CY2	1nF/3KV			

- The products do not support parallel connection of their output
- For additional information please refer to DC-DC converter application notes on www.mornsun-power.com

Dimensions and Recommended Layout

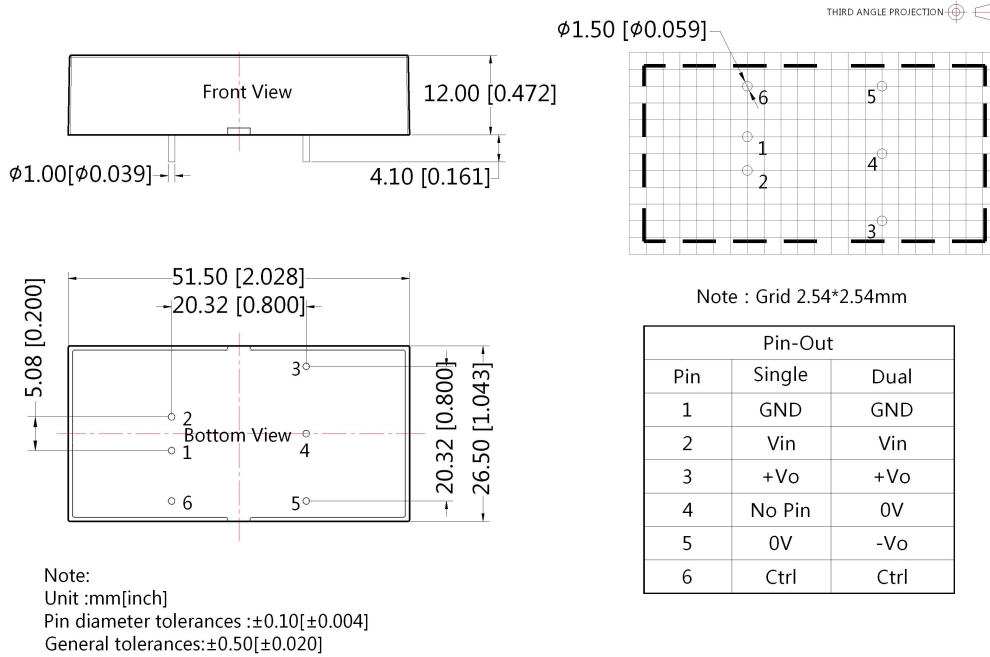

URE_LP-10WR3A2S & URF_LP-10WR3A2S Dimensions

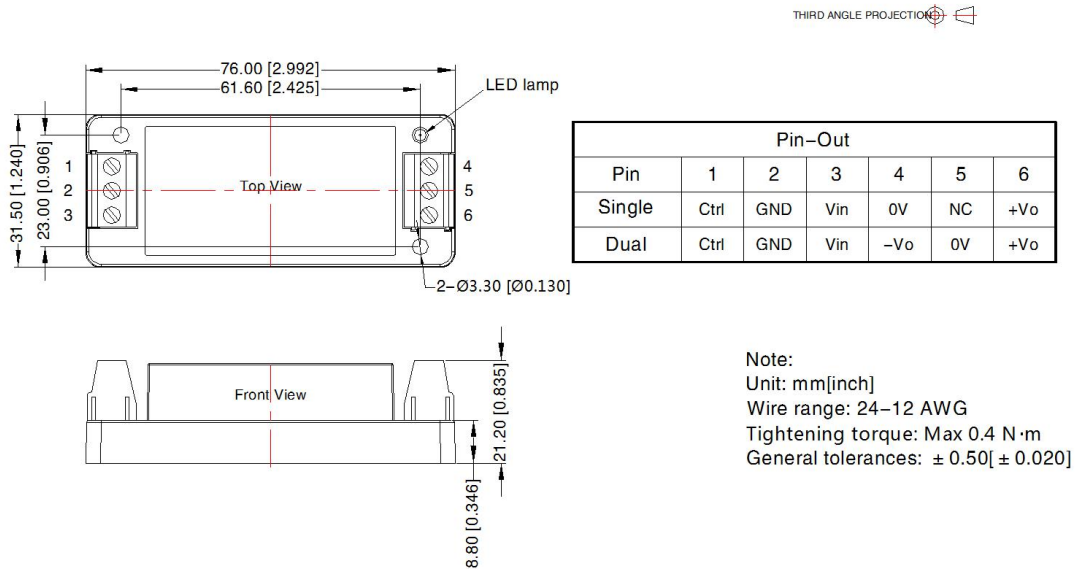

URE_LP-10WR3A4S & URF_LP-10WR3A4S Dimensions

THIRD ANGLE PROJECTION

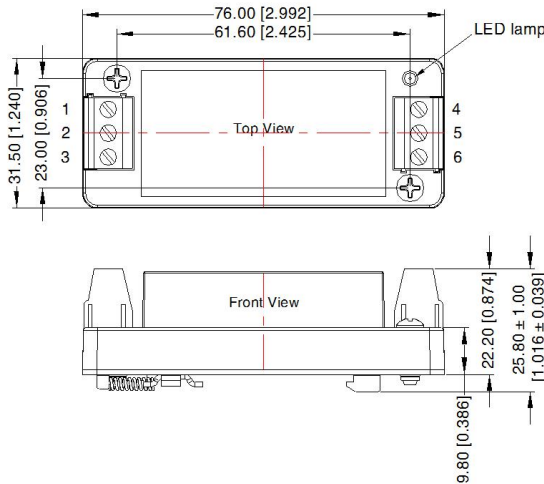

Pin-Out						
Pin	1	2	3	4	5	6
Single	Ctrl	GND	Vin	0V	NC	+Vo
Dual	Ctrl	GND	Vin	-Vo	0V	+Vo

Note:
 Unit: mm[inch]
 Mounting rail: TS35
 Wire range: 24-12 AWG
 Tightening torque: Max 0.4 N·m
 General tolerances: ± 0.50 [± 0.020]

Note:

- For additional information on Product Packaging please refer to www.mornsun-power.com. Packaging bag number: 58210039(DIP), 58220022(A2S/A4S package);
- It is recommended that the load imbalance of the dual output is $\leq \pm 5\%$. If it exceeds $\pm 5\%$, the performance of the product cannot be guaranteed to meet as datasheet marked. For details, please contact our technical staff;
- The maximum capacitive load offered were tested at input voltage range and full load;
- Unless otherwise specified, parameters in this datasheet were measured under the conditions of $T_a=25^\circ\text{C}$, humidity < 75%RH with nominal input voltage and rated output load;
- All index testing methods in this datasheet are based on company corporate standards;
- We can provide product customization service, please contact our technicians directly for specific information;
- Products are related to laws and regulations: see "Features" and "EMC";
- Our products shall be classified according to ISO14001 and related environmental laws and regulations, and shall be handled by qualified units.

Mornsun Guangzhou Science & Technology Co., Ltd.

Address: No. 5, Kehui St. 1, Kehui Development Center, Science Ave., Guangzhou Science City, Huangpu District, Guangzhou, P. R. China

Tel: 86-20-38601850

Fax: 86-20-38601272

E-mail: info@mornsun.cn

www.mornsun-power.com