

OPA2156 36-V, Ultra-Low Noise, Wide-Bandwidth, CMOS, Precision, Rail-to-Rail, Operational Amplifier

1 Features

- Ultra-low noise: $3 \text{ nV}/\sqrt{\text{Hz}}$ at 10 kHz
- Low offset voltage: $\pm 25 \mu\text{V}$
- Low offset voltage drift: $\pm 0.5 \mu\text{V}/^\circ\text{C}$
- Low bias current: $\pm 5 \text{ pA}$
- Common-Mode Rejection: 120dB
- Low Noise: $3 \text{ nV}/\sqrt{\text{Hz}}$ at 10 kHz
- Wide bandwidth: 25-MHz GBW
- Open-loop voltage gain: 154 dB
- High output current: 100 mA
- Rail-to-rail input and output
- High slew rate: $40 \text{ V}/\mu\text{s}$
- Fast settling time: 600 ns (10-V step, 0.01%)
- Wide supply: $\pm 2.25 \text{ V}$ to $\pm 18 \text{ V}$, 4.5 V to 36 V
- Industry standard packages:
 - Dual in SOIC-8 and VSSOP-8

2 Applications

- Data acquisition (DAQ)
- Photodiode Transimpedance Amplifiers
- Vibration monitor module
- Analog input module
- High-Resolution ADC Driver Amplifiers
- Medical Equipment

3 Description

The OPA2156 is the first in a planned new generation of 36-V, rail-to-rail operational amplifiers (op amps).

This devices offers very low offset voltage ($\pm 25 \mu\text{V}$), drift ($\pm 0.5 \mu\text{V}/^\circ\text{C}$), and low bias current ($\pm 5 \text{ pA}$) combined with very low broadband voltage noise ($3 \text{ nV}/\sqrt{\text{Hz}}$).

Unique features, such as rail-to-rail input and output voltage ranges, wide bandwidth (25 MHz) high output current (100 mA), and high slew rate ($40 \text{ V}/\mu\text{s}$) make the OPA2156 a robust, high-performance operational amplifier for high-voltage precision industrial applications.

The OPA2156 op amp is available in 8-pin SOIC and VSSOP packages and is specified over the industrial temperature range of -40°C to $+125^\circ\text{C}$.

Device Information⁽¹⁾

PART NUMBER	PACKAGE	BODY SIZE (NOM)
OPA2156	SOIC (8)	4.90 mm x 3.90 mm
	VSSOP (8)	3.00 mm x 3.00 mm

(1) For all available packages, see the package option addendum at the end of the data sheet.

Low Input Voltage Noise Spectral Density

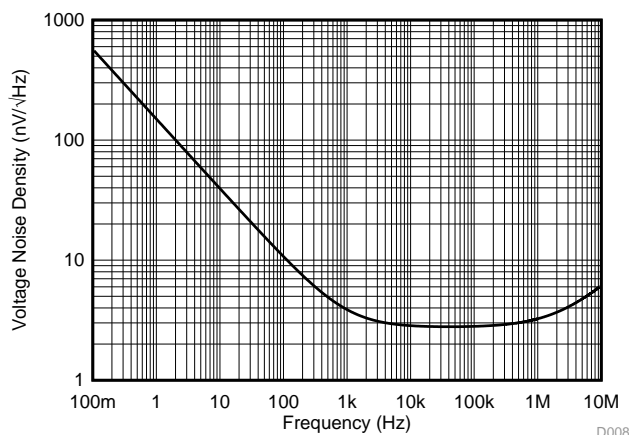

OPA2156 Transimpedance Configuration

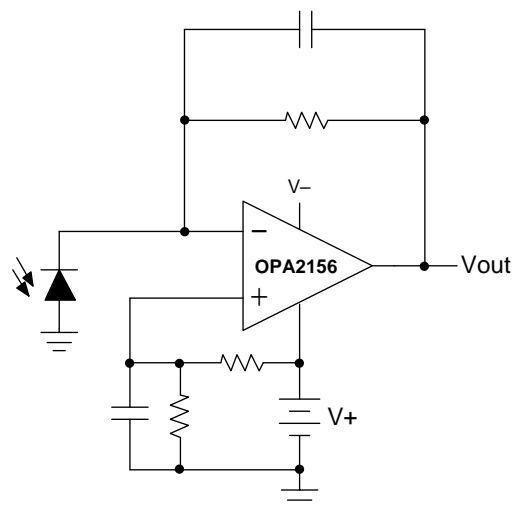

Table of Contents

1	Features	1	8	Application and Implementation	20
2	Applications	1	8.1	Application Information.....	20
3	Description	1	8.2	Typical Application	21
4	Revision History	2	9	Power Supply Recommendations	23
5	Pin Configuration and Functions	3	10	Layout	23
6	Specifications	4	10.1	Layout Guidelines	23
6.1	Absolute Maximum Ratings	4	10.2	Layout Example	24
6.2	ESD Ratings.....	4	11	Device and Documentation Support	25
6.3	Recommended Operating Conditions	4	11.1	Device Support.....	25
6.4	Thermal Information: OPA2156	4	11.2	Documentation Support	25
6.5	Electrical Characteristics.....	5	11.3	Receiving Notification of Documentation Updates	25
6.6	Typical Characteristics	7	11.4	Community Resources.....	25
7	Detailed Description	15	11.5	Trademarks	25
7.1	Overview	15	11.6	Electrostatic Discharge Caution.....	26
7.2	Functional Block Diagram	15	11.7	Glossary	26
7.3	Feature Description.....	15	12	Mechanical, Packaging, and Orderable Information	26
7.4	Device Functional Modes.....	19			

4 Revision History

NOTE: Page numbers for previous revisions may differ from page numbers in the current version.

Changes from Revision A (December 2018) to Revision B	Page
• Added new DGK (VSSOP) package and associated content to data sheet	1
• Changed Figure 8, <i>Input Voltage Noise Spectral Density</i> , to include frequencies up to 10 MHz.....	8
• Changed title of input bias and offset current curves (Figures 12 to 14) to specify SOIC package performance	9

Changes from Original (September 2018) to Revision A	Page
• First release of production-data data sheet.....	1

5 Pin Configuration and Functions

**D and DGK Packages
8-Pin SOIC and 8-Pin VSSOP
Top View**

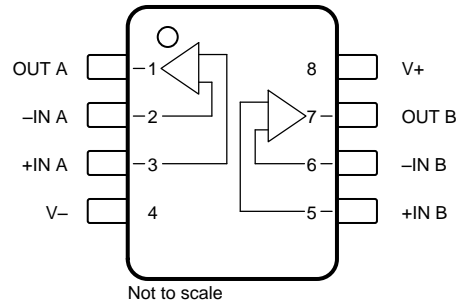

Pin Functions

PIN		I/O	DESCRIPTION
NAME	NO.		
+IN A	3	I	Noninverting input, channel A
+IN B	5	I	Noninverting input, channel B
-IN A	2	I	Inverting input, channel A
-IN B	6	I	Inverting input, channel B
OUT A	1	O	Output, channel A
OUT B	7	O	Output, channel B
V+	8	—	Positive (highest) power supply
V-	4	—	Negative (lowest) power supply

6 Specifications

6.1 Absolute Maximum Ratings

over operating free-air temperature range (unless otherwise noted)⁽¹⁾

			MIN	MAX	UNIT
Supply voltage, $V_S = (V+) - (V-)$			±20 (+40, single supply)		V
Signal input pins	Voltage	Common-mode	(V-) – 0.5	(V+) + 0.5	V
		Differential	0.5		
Current			±10		mA
Output short circuit ⁽²⁾			Continuous		
Temperature	Operating junction		–40	150	°C
	Storage, T_{stg}		–65	150	

- (1) Stresses beyond those listed under *Absolute Maximum Ratings* may cause permanent damage to the device. These are stress ratings only, which do not imply functional operation of the device at these or any other conditions beyond those indicated under *Recommended Operating Conditions*. Exposure to absolute-maximum-rated conditions for extended periods may affect device reliability.
- (2) Short-circuit to ground, one amplifier per package.

6.2 ESD Ratings

			VALUE	UNIT
$V_{(ESD)}$	Electrostatic discharge	Human-body model (HBM), per ANSI/ESDA/JEDEC JS-001 ⁽¹⁾	±3000	V
		Charged-device model (CDM), per JEDEC specification JESD22-C101 ⁽²⁾	±1000	V

- (1) JEDEC document JEP155 states that 500-V HBM allows safe manufacturing with a standard ESD control process.
- (2) JEDEC document JEP157 states that 250-V CDM allows safe manufacturing with a standard ESD control process.

6.3 Recommended Operating Conditions

over operating free-air temperature range (unless otherwise noted)

	MIN	NOM	MAX	UNIT
Supply voltage, $V_S = (V+) - (V-)$	4.5 (±2.25)		36 (±18)	V
Specified temperature (SOIC) ⁽¹⁾	–40		125	°C

- (1) Please see [Thermal Considerations](#) section for information on ambient vs device junction temperature

6.4 Thermal Information: OPA2156

THERMAL METRIC ⁽¹⁾		OPA2156		UNIT
		8 PINS		
		D (SOIC)	DGK (VSSOP)	
$R_{\theta JA}$	Junction-to-ambient thermal resistance	119.2	163.8	°C/W
$R_{\theta JC(top)}$	Junction-to-case(top) thermal resistance	51.1	52.5	°C/W
$R_{\theta JB}$	Junction-to-board thermal resistance	64.7	86.5	°C/W
Ψ_{JT}	Junction-to-top characterization parameter	9.7	5.1	°C/W
Ψ_{JB}	Junction-to-board characterization parameter	63.5	84.7	°C/W

- (1) For more information about traditional and new thermal metrics, see the *Semiconductor and IC Package Thermal Metrics* application report, [SPRA953](#).

6.5 Electrical Characteristics

at $T_A = 25^\circ\text{C}$, $V_S = \pm 2.25\text{V}$ to $\pm 18\text{V}$, $V_{CM} = V_{OUT} = V_S / 2$, and $R_L = 2\text{ k}\Omega$ connected to $V_S / 2$ (unless otherwise noted)

PARAMETER		TEST CONDITIONS		MIN	TYP	MAX	UNIT	
OFFSET VOLTAGE								
V_{OS}	Input offset voltage, PMOS	$T_A = -40^\circ\text{C}$ to $+85^\circ\text{C}$			± 25	± 200	μV	
		$T_A = -40^\circ\text{C}$ to $+125^\circ\text{C}$				± 300	μV	
V_{OS}	Input offset voltage, NMOS	$V_{CM} = (V+) - 1.25\text{ V}$			± 0.25	± 3	mV	
		$V_{CM} = (V+) - 1.25\text{ V}$, $T_A = -40^\circ\text{C}$ to $+125^\circ\text{C}$ (SOIC)						
		$V_{CM} = (V+) - 1.25\text{ V}$, $T_A = -40^\circ\text{C}$ to $+105^\circ\text{C}$ (MSOP)					± 5	mV
dV_{OS}/dT	Input offset voltage drift	PMOS, SOIC	$T_A = -40^\circ\text{C}$ to $+125^\circ\text{C}$		± 0.5	± 3	$\mu\text{V}/^\circ\text{C}$	
		PMOS, MSOP	$T_A = -40^\circ\text{C}$ to $+105^\circ\text{C}$					
		NMOS, $V_{CM} = (V+) - 1.25\text{ V}$	$T_A = -40^\circ\text{C}$ to $+125^\circ\text{C}$		± 1			
PSRR	Power-supply rejection ratio	$T_A = -40^\circ\text{C}$ to $+125^\circ\text{C}$ (SOIC)			± 0.3	± 4.5	$\mu\text{V}/\text{V}$	
		$T_A = -40^\circ\text{C}$ to $+105^\circ\text{C}$ (MSOP)				± 5		
INPUT BIAS CURRENT								
I_B	Input bias current	SOIC			± 5	± 40	pA	
		MSOP			± 5	± 80	pA	
		$T_A = -40^\circ\text{C}$ to $+85^\circ\text{C}$ (SOIC)					± 1.5	nA
		$T_A = -40^\circ\text{C}$ to $+85^\circ\text{C}$ (MSOP)					± 15	nA
		$T_A = -40^\circ\text{C}$ to $+125^\circ\text{C}$					See Typical Characteristics	nA
I_{OS}	Input offset current				± 2	± 40	pA	
		$T_A = -40^\circ\text{C}$ to $+85^\circ\text{C}$ (SOIC)					± 1.5	nA
		$T_A = -40^\circ\text{C}$ to $+85^\circ\text{C}$ (MSOP)					± 2.5	nA
		$T_A = -40^\circ\text{C}$ to $+125^\circ\text{C}$					See Typical Characteristics	nA
NOISE								
E_n	Input voltage noise	$(V-) < V_{CM} < (V+) - 2.25\text{ V}$	$f = 0.1\text{ Hz}$ to 10 Hz		1.9		μV_{PP}	
		$(V+) - 1.25\text{ V} < V_{CM} < (V+)$	$f = 0.1\text{ Hz}$ to 10 Hz		3.4			
e_n	Input voltage noise density	$(V-) < V_{CM} < (V+) - 2.25\text{ V}$	$f = 100\text{ Hz}$		12.0		$\text{nV}/\sqrt{\text{Hz}}$	
			$f = 1\text{ kHz}$		4			
			$f = 10\text{ kHz}$		3.0			
e_n	Input voltage noise density	$(V+) - 1.25\text{ V} < V_{CM} < (V+)$	$f = 100\text{ Hz}$		13.0			
			$f = 1\text{ kHz}$		9.7			
			$f = 10\text{ kHz}$		4.0			
i_n	Input current noise density	$f = 1\text{ kHz}$			19		$\text{fA}/\sqrt{\text{Hz}}$	
INPUT VOLTAGE								
V_{CM}	Common-mode voltage range			$(V-) - 0.1$		$(V+) + 0.1$	V	
CMRR	Common-mode rejection ratio, PMOS	$(V-) < V_{CM} < (V+) - 2.25\text{ V}$, $V_S = \pm 18\text{ V}$		106	120		dB	
CMRR	Common-mode rejection ratio, PMOS	$T_A = -40^\circ\text{C}$ to $+125^\circ\text{C}$ (SOIC)		100				
CMRR	Common-mode rejection ratio, PMOS	$T_A = -40^\circ\text{C}$ to $+105^\circ\text{C}$ (MSOP)						
CMRR	Common-mode rejection ratio, NMOS	$(V+) - 1.25\text{ V} < V_{CM} < (V+)$, $V_S = \pm 18\text{ V}$		82	120			
CMRR	Common-mode rejection ratio, NMOS	$T_A = -40^\circ\text{C}$ to $+125^\circ\text{C}$ (SOIC)		74				
CMRR	Common-mode rejection ratio, NMOS	$T_A = -40^\circ\text{C}$ to $+105^\circ\text{C}$ (MSOP)						

Electrical Characteristics (continued)

at $T_A = 25^\circ\text{C}$, $V_S = \pm 2.25\text{V}$ to $\pm 18\text{V}$, $V_{CM} = V_{OUT} = V_S / 2$, and $R_L = 2\text{ k}\Omega$ connected to $V_S / 2$ (unless otherwise noted)

PARAMETER		TEST CONDITIONS	MIN	TYP	MAX	UNIT
INPUT IMPEDANCE						
Z_{ID}	Differential		100 9.1			$\text{M}\Omega$ pF
Z_{IC}	Common-mode		6 1.9			$10^{12}\Omega$ pF
OPEN-LOOP GAIN						
A_{OL}	Open-loop voltage gain	$(V_-) + 0.6\text{ V} < V_O < (V_+) - 0.6\text{ V}$, $V_S = \pm 18\text{ V}$ (SOIC)	130	154		dB
		$(V_-) + 0.6\text{ V} < V_O < (V_+) - 0.6\text{ V}$, $V_S = \pm 18\text{ V}$ (MSOP)	128	154		
		$T_A = -40^\circ\text{C}$ to $+85^\circ\text{C}$	126			
FREQUENCY RESPONSE						
GBW	Unity gain bandwidth		20			MHz
	Gain bandwidth product	$G = 100$	25			MHz
SR	Slew rate	$V_S = \pm 18\text{ V}$, $G = -1$, 10-V step	40			$\text{V}/\mu\text{s}$
t_s	Settling time	To 0.01%, $C_L = 20\text{ pF}$	$V_S = \pm 18\text{ V}$, $G = -1$, 10-V step		600	ns
t_{OR}	Overload recovery time	$G = -10$			100	ns
THD+N	Total harmonic distortion + noise	$G = 1$, $f = 1\text{ kHz}$, $V_O = 3.5\text{ V}_{RMS}$	-132			dB
			0.000025 %			
		$G = 1$, $f = 20\text{ kHz}$, $V_O = 3.5\text{ V}_{RMS}$	-126			dB
			0.00005%			
Crosstalk		dc	150			dB
		$f = 100\text{ kHz}$	120			dB
OUTPUT						
V_O	Voltage output swing from power supply		200	250		mV
I_{SC}	Short-circuit current	$V_S = \pm 18\text{ V}$	100			mA
C_L	Capacitive load drive		See Typical Characteristics			pF
Z_O	Open-loop output impedance	$f = 1\text{ MHz}$, $I_O = 0\text{ A}$	25			Ω
POWER SUPPLY						
I_Q	Quiescent current per amplifier	$I_O = 0\text{ A}$	4.4		5.2	mA
			$T_A = -40^\circ\text{C}$ to $+125^\circ\text{C}$ (SOIC)		5.2	
			$T_A = -40^\circ\text{C}$ to $+105^\circ\text{C}$ (MSOP)			
TEMPERATURE						
	Thermal protection		170			$^\circ\text{C}$
	Thermal hysteresis		15			$^\circ\text{C}$

6.6 Typical Characteristics

Table 1. Table of Graphs

DESCRIPTION	FIGURE
Offset Voltage Production Distribution	Figure 1
Offset Voltage vs Temperature (PMOS)	Figure 2
Offset Voltage vs Temperature (NMOS)	Figure 3
Offset Voltage vs Power Supply	Figure 4
Offset Voltage vs Common-Mode Voltage	Figure 5
Offset Voltage vs Common-Mode Voltage in Transition Region	Figure 6
Offset Voltage Drift	Figure 7
Input Voltage Noise Spectral Density	Figure 8
0.1-Hz to 10-Hz Noise	Figure 9
THD+N vs Frequency	Figure 10
THD+N vs Output Amplitude	Figure 11
Input Bias and Offset Current vs Common-Mode Voltage	Figure 12
Input Bias and Offset Current vs Temperature	Figure 13
Input Bias and Offset Current vs Temperature	Figure 14
Open-Loop Output Impedance vs Frequency	Figure 15
Maximum Output Voltage vs Frequency	Figure 16
Open-Loop Gain and Phase Vs Frequency	Figure 17
Open-Loop Gain vs Temperature	Figure 18
Closed-Loop Gain vs Frequency	Figure 19
CMRR vs Frequency	Figure 20
PSRR vs Frequency	Figure 21
CMRR vs Temperature	Figure 22
PSRR vs Temperature	Figure 23
Positive Output Voltage vs Output Current	Figure 24
Negative Output Voltage vs Output Current	Figure 26
Short-Circuit Current vs Temperature	Figure 25
No Phase Reversal	Figure 27
Phase Margin vs Capacitive Load	Figure 28
Small-Signal Overshoot vs Capacitive Load (G = -1)	Figure 29
Small-Signal Overshoot vs Capacitive Load (G = +1)	Figure 30
Settling Time	Figure 31
Negative Overload Recovery	Figure 32
Positive Overload Recovery	Figure 33
Small-Signal Step Response (Noninverting)	Figure 34
Small-Signal Step Response (Inverting)	Figure 35
Large-Signal Step Response (Noninverting)	Figure 36
Large-Signal Step Response (Inverting)	Figure 37
Quiescent Current vs Supply Voltage	Figure 38
Quiescent Current vs Temperature	Figure 39
Channel Separation vs Frequency	Figure 40
EMIRR vs Frequency	Figure 41

at $T_A = 25^\circ\text{C}$, $V_S = \pm 18\text{ V}$, $V_{CM} = V_S / 2$, $R_L = 10\text{ k}\Omega$ connected to $V_S / 2$, and $C_L = 30\text{ pF}$ (unless otherwise noted)

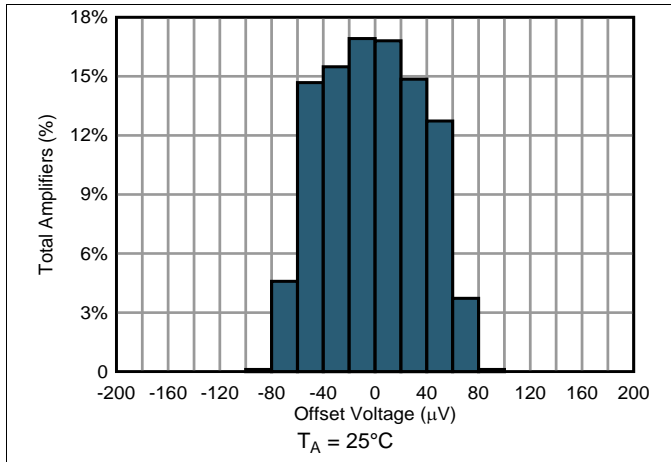

Figure 1. Offset Voltage Production Distribution

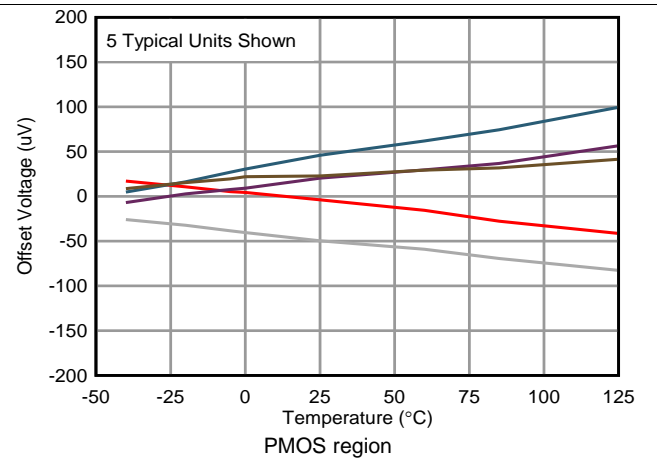

Figure 2. Offset Voltage vs Temperature (PMOS)

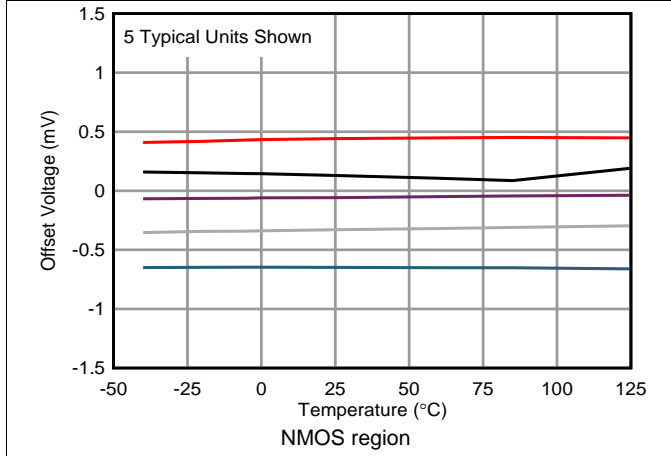

Figure 3. Offset Voltage vs Temperature (NMOS)

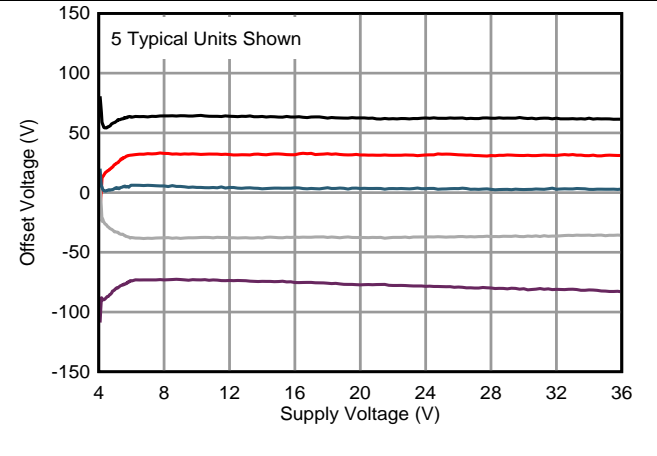

Figure 4. Offset Voltage vs Power Supply

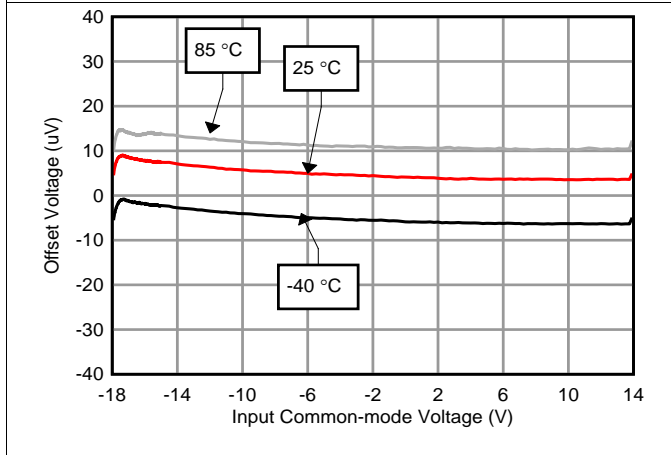

Figure 5. Offset Voltage vs Common-Mode Voltage

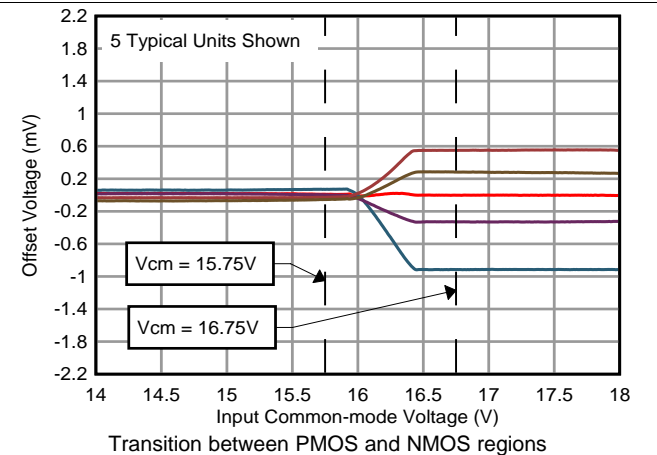

Figure 6. Offset Voltage vs Common-Mode Voltage in Transition Region

at $T_A = 25^\circ\text{C}$, $V_S = \pm 18\text{ V}$, $V_{CM} = V_S / 2$, $R_L = 10\text{ k}\Omega$ connected to $V_S / 2$, and $C_L = 30\text{ pF}$ (unless otherwise noted)

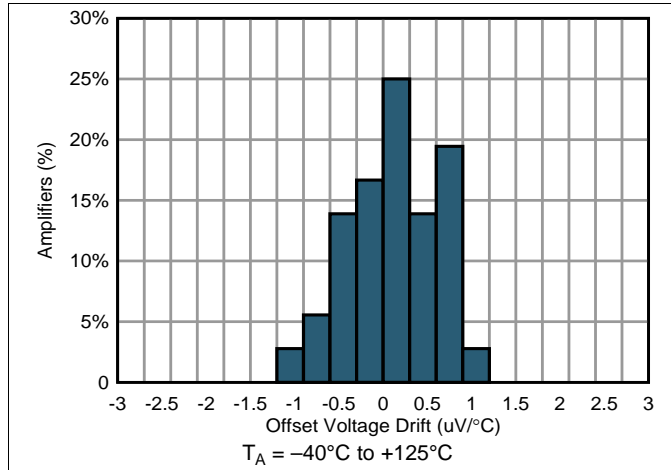

Figure 7. Offset Voltage Drift

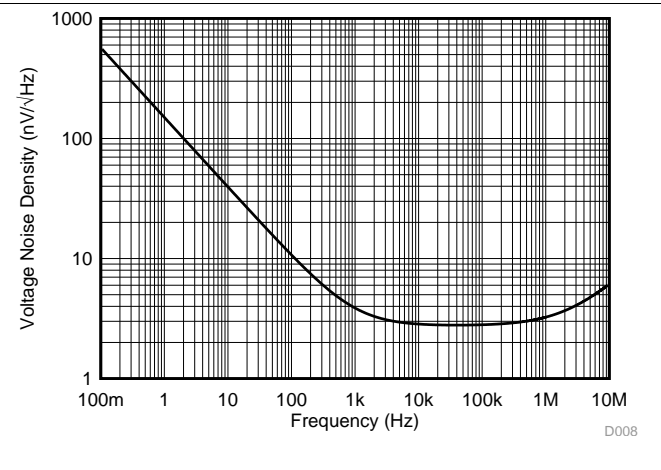

Figure 8. Input Voltage Noise Spectral Density

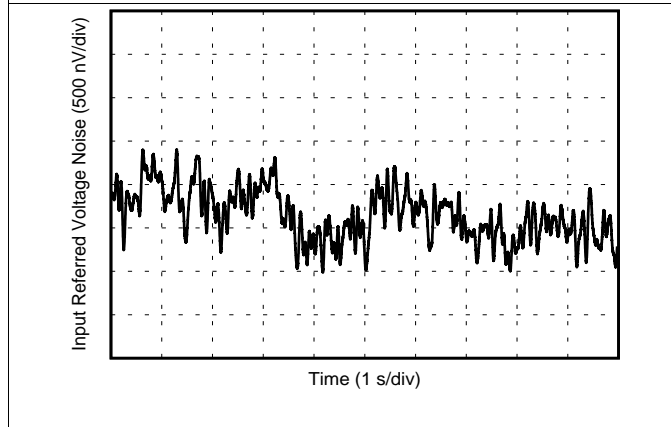
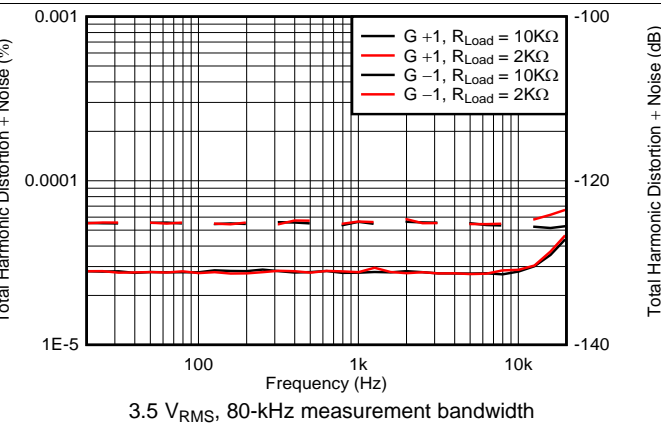
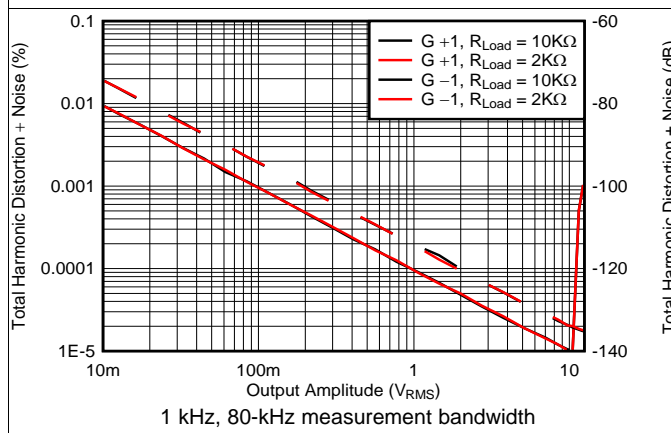

Figure 9. 0.1-Hz to 10-Hz Noise



3.5 V_{RMS} , 80-kHz measurement bandwidth

Figure 10. THD+N vs Frequency



1 kHz, 80-kHz measurement bandwidth

Figure 11. THD+N vs Output Amplitude

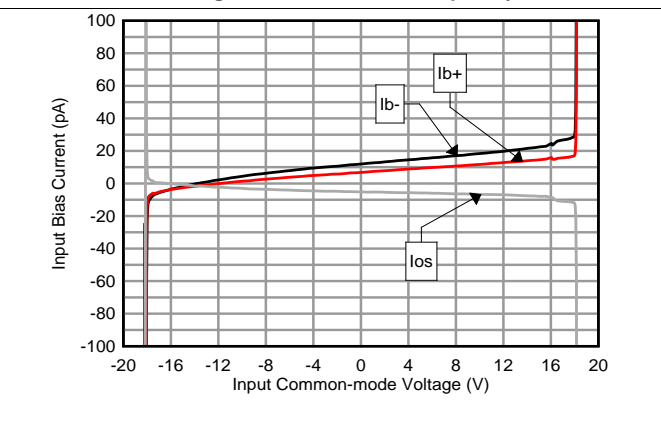

Figure 12. Input Bias and Offset Current vs Common-Mode Voltage (SOIC)

at $T_A = 25^\circ\text{C}$, $V_S = \pm 18\text{ V}$, $V_{CM} = V_S / 2$, $R_L = 10\text{ k}\Omega$ connected to $V_S / 2$, and $C_L = 30\text{ pF}$ (unless otherwise noted)

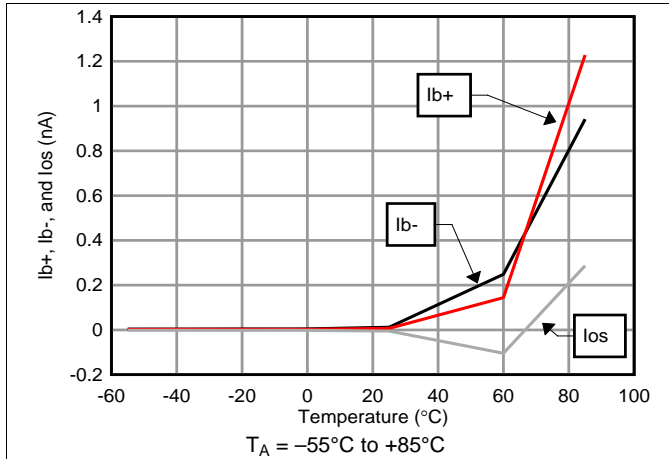

Figure 13. Input Bias and Offset Current vs Temperature (SOIC)

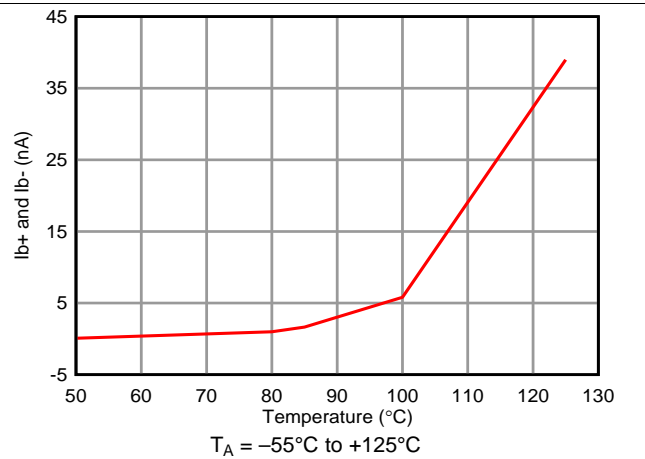

Figure 14. Input Bias and Offset Current vs Temperature (SOIC)

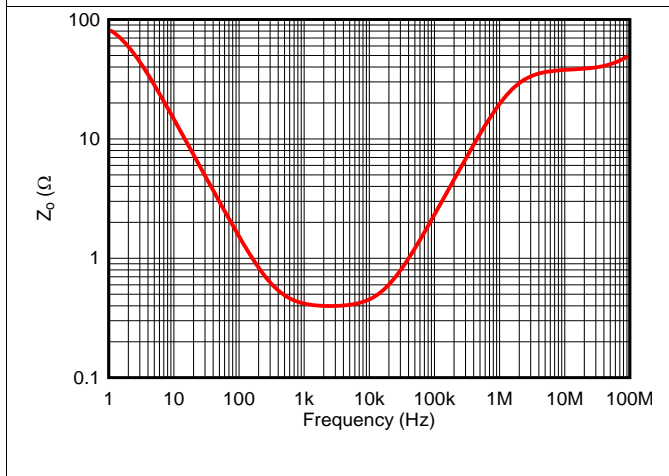

Figure 15. Open-Loop Output Impedance vs Frequency

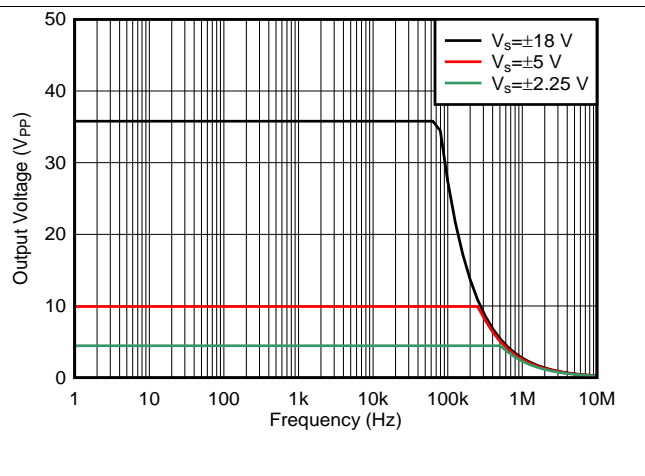

Figure 16. Maximum Output Voltage vs Frequency

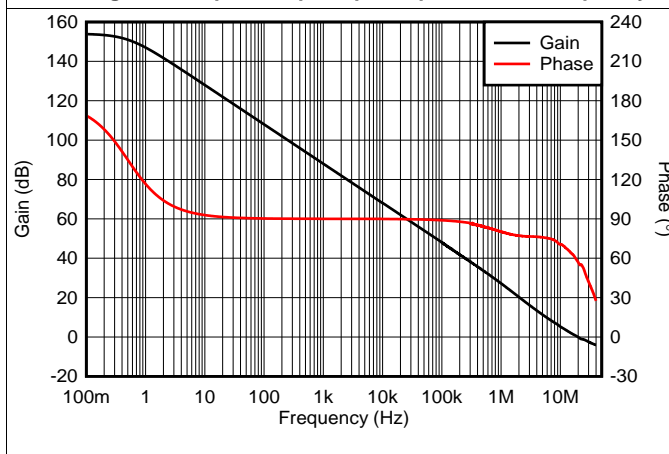

Figure 17. Open-Loop Gain and Phase vs Frequency

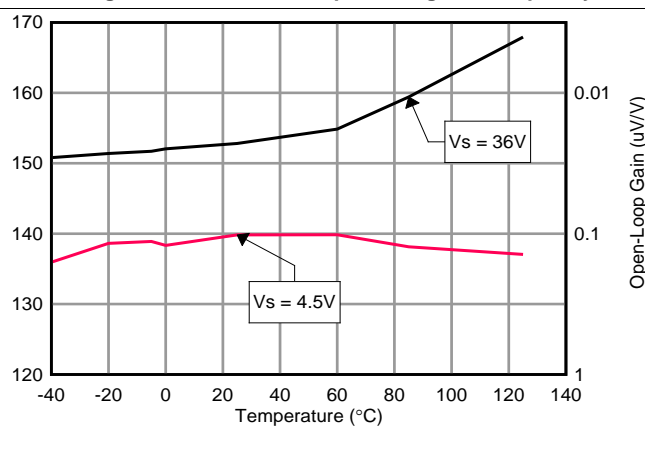
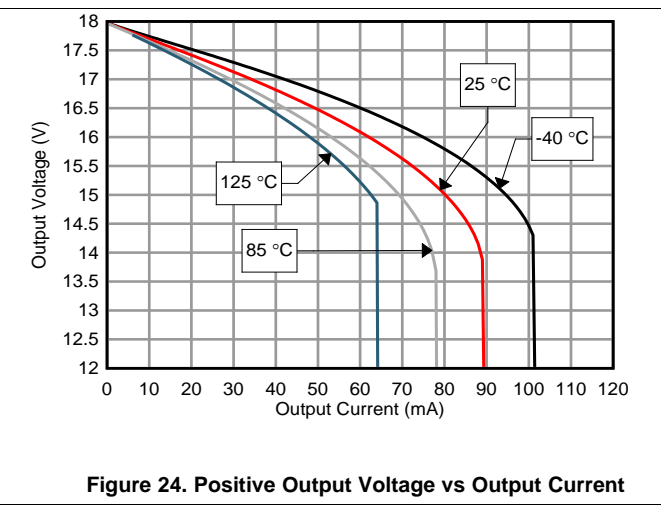
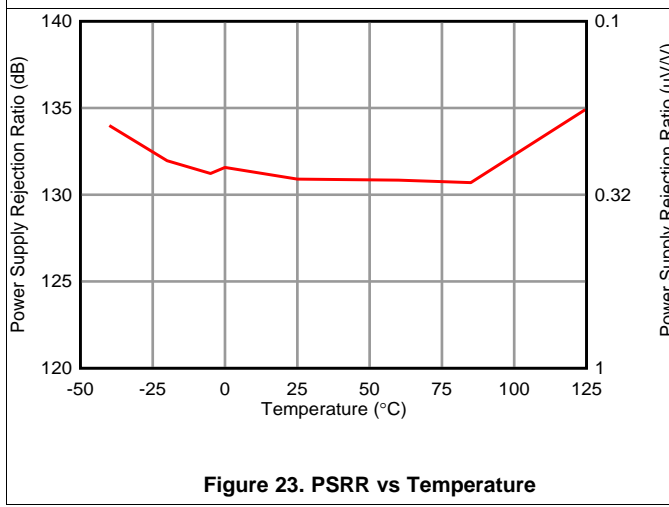
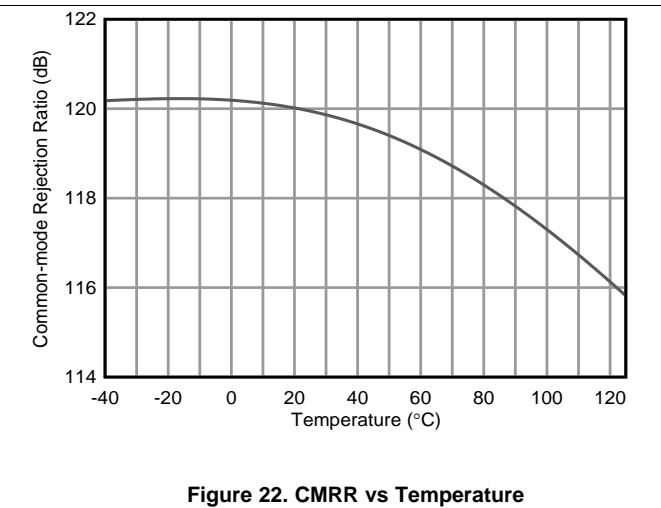
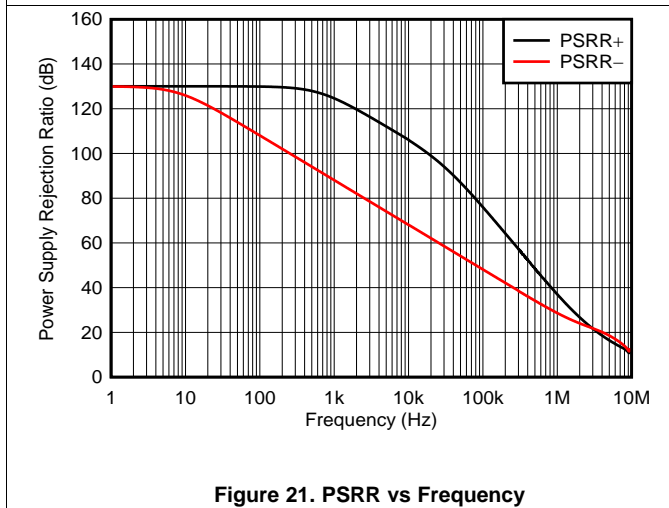
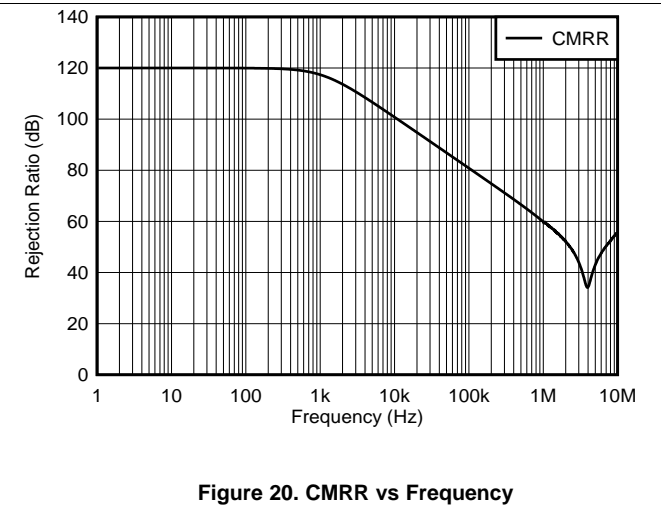
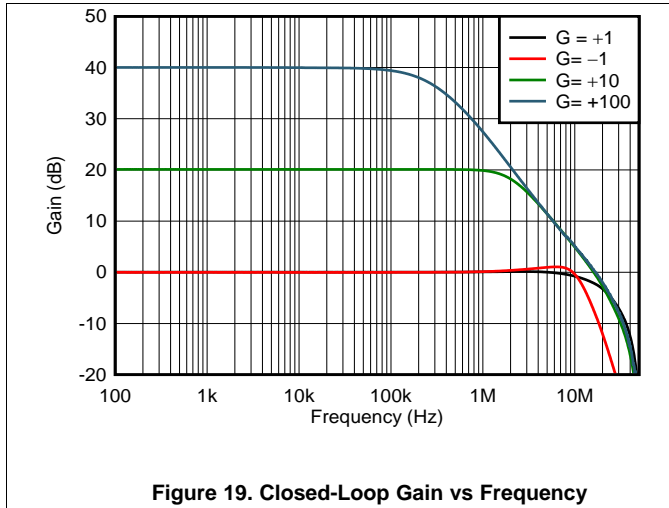
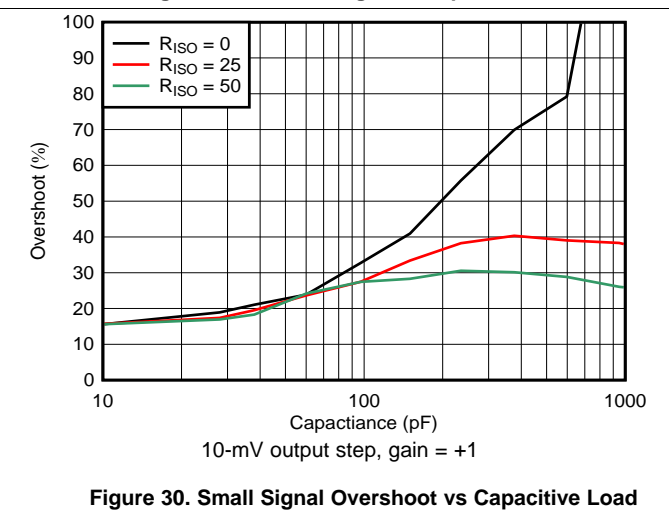
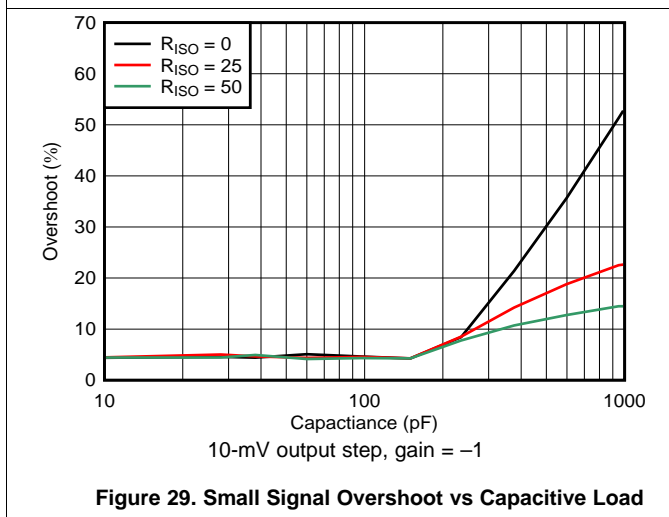
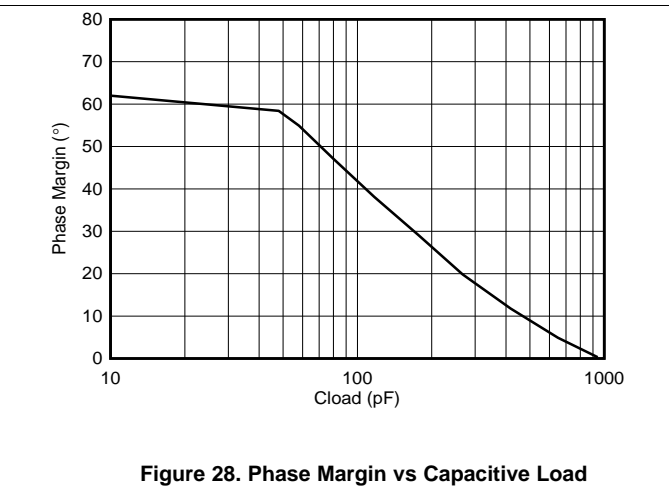
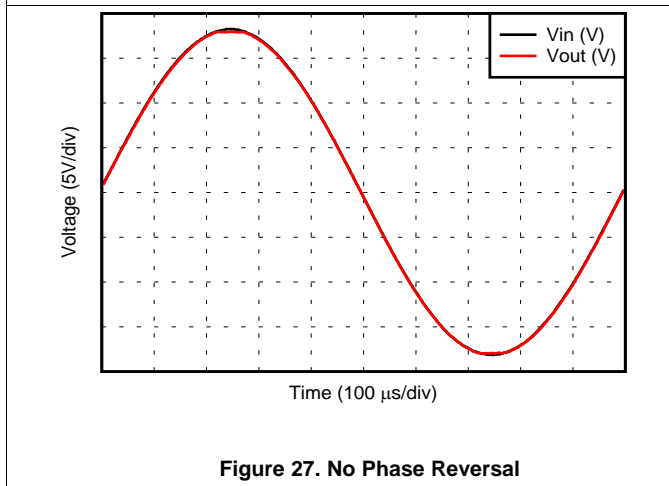
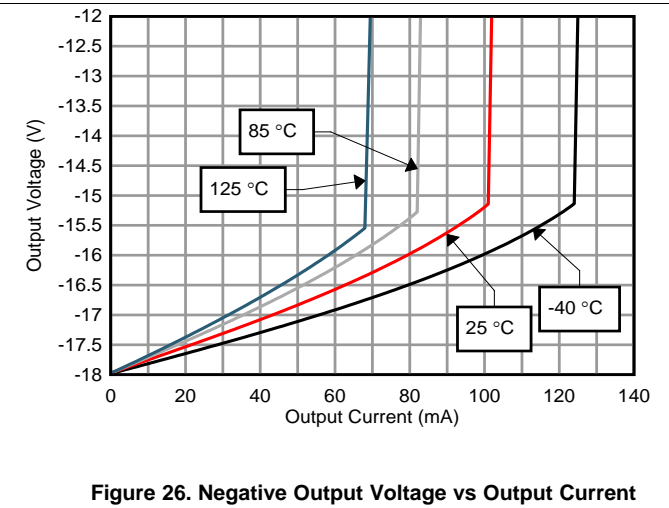
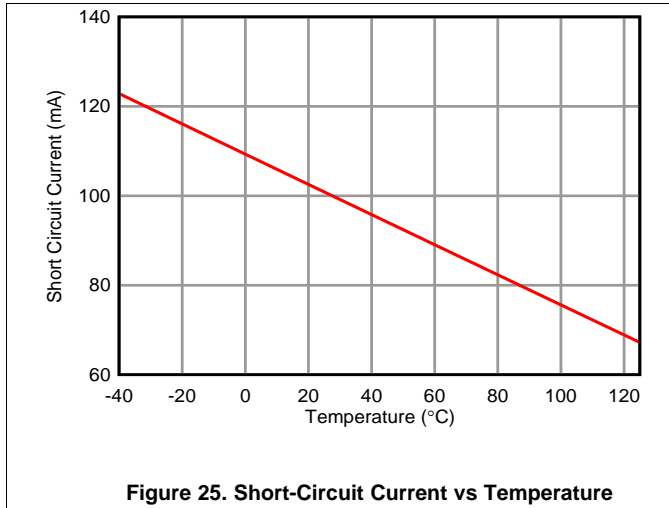

Figure 18. Open-Loop Gain vs Temperature

at $T_A = 25^\circ\text{C}$, $V_S = \pm 18\text{ V}$, $V_{CM} = V_S / 2$, $R_L = 10\text{ k}\Omega$ connected to $V_S / 2$, and $C_L = 30\text{ pF}$ (unless otherwise noted)



at $T_A = 25^\circ\text{C}$, $V_S = \pm 18\text{ V}$, $V_{CM} = V_S / 2$, $R_L = 10\text{ k}\Omega$ connected to $V_S / 2$, and $C_L = 30\text{ pF}$ (unless otherwise noted)



at $T_A = 25^\circ\text{C}$, $V_S = \pm 18\text{ V}$, $V_{CM} = V_S / 2$, $R_L = 10\text{ k}\Omega$ connected to $V_S / 2$, and $C_L = 30\text{ pF}$ (unless otherwise noted)

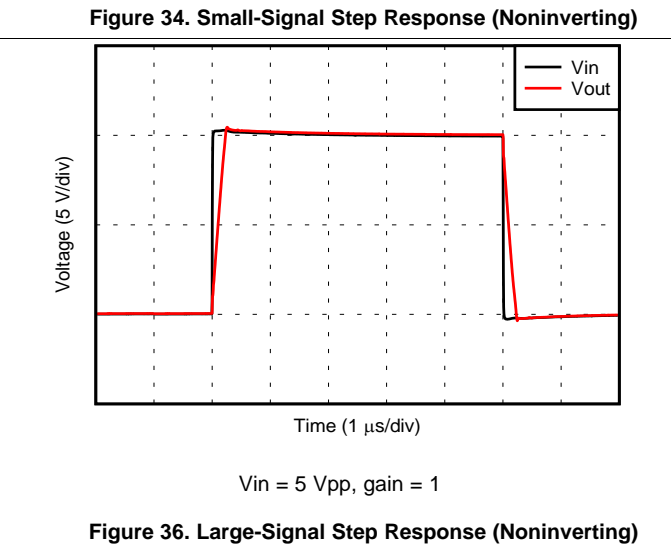
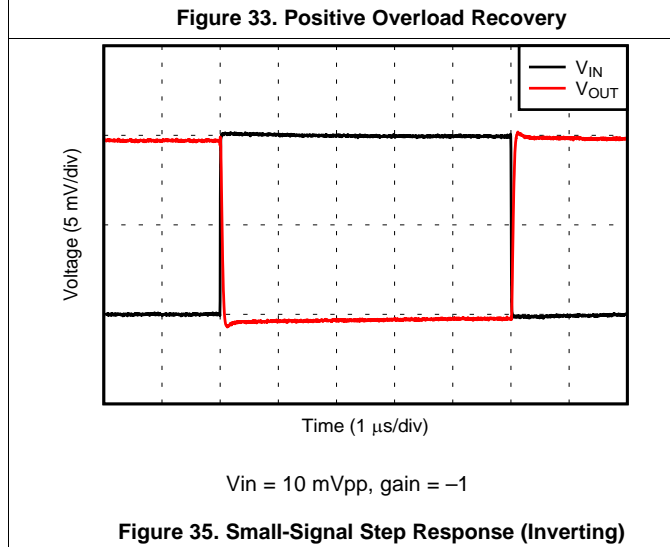
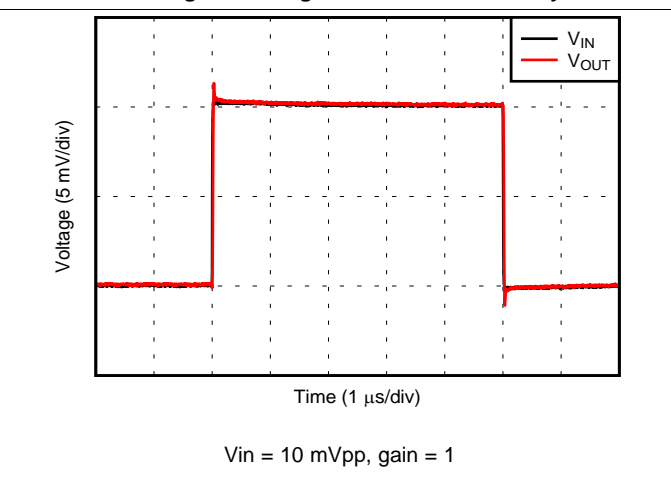
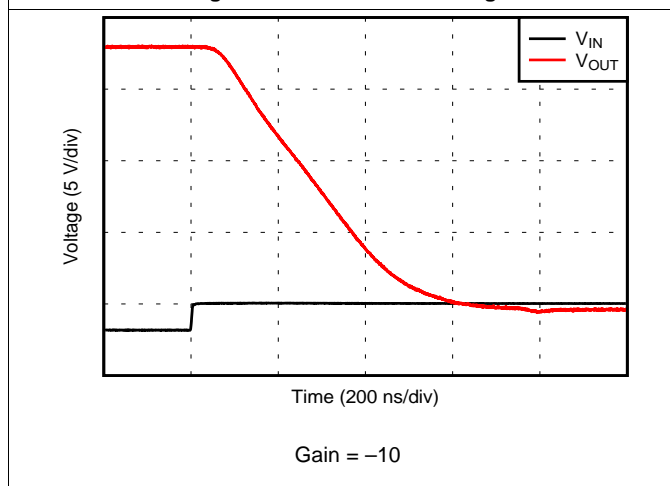
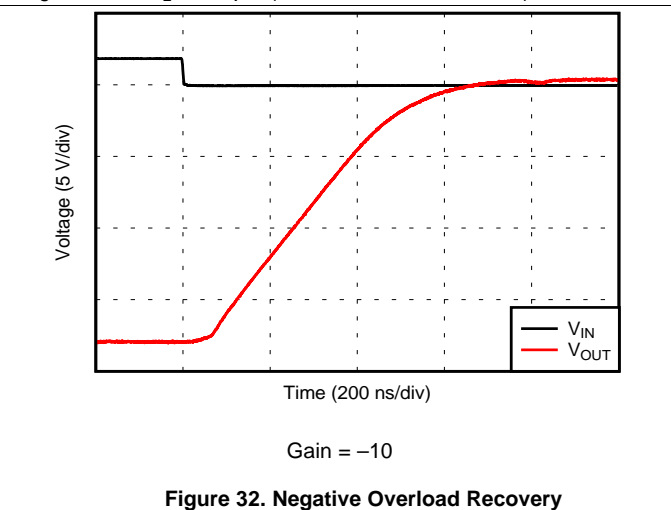
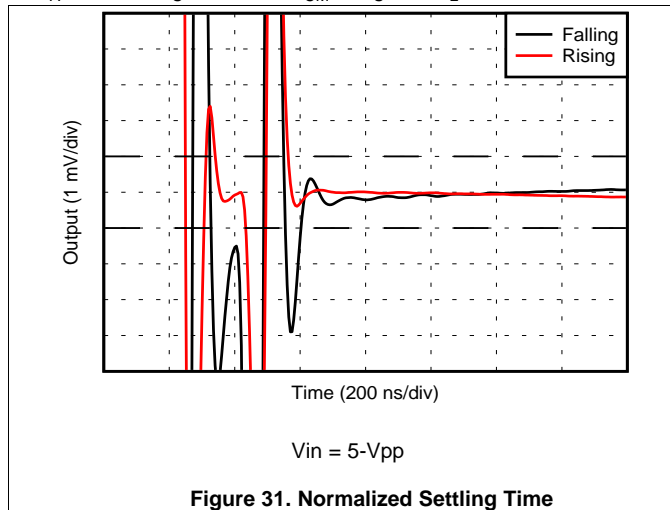

at $T_A = 25^\circ\text{C}$, $V_S = \pm 18\text{ V}$, $V_{CM} = V_S / 2$, $R_L = 10\text{ k}\Omega$ connected to $V_S / 2$, and $C_L = 30\text{ pF}$ (unless otherwise noted)

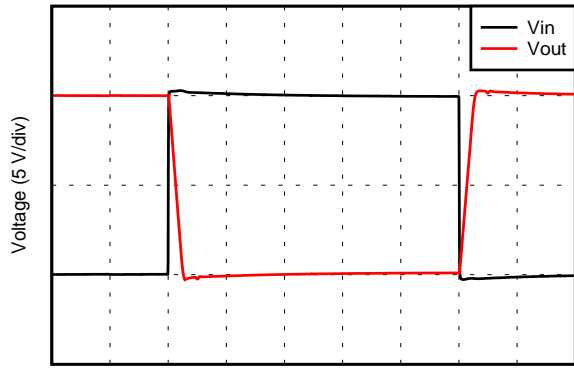

$V_{in} = 5\text{ Vpp}$, gain = -1

Figure 37. Large Signal Step Response (Inverting)

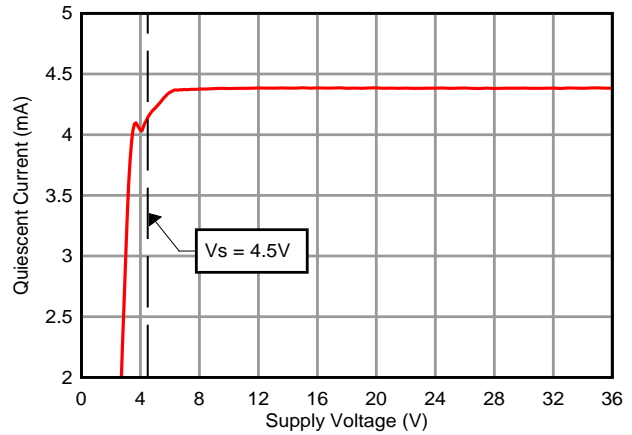

Figure 38. Quiescent Current vs Supply Voltage

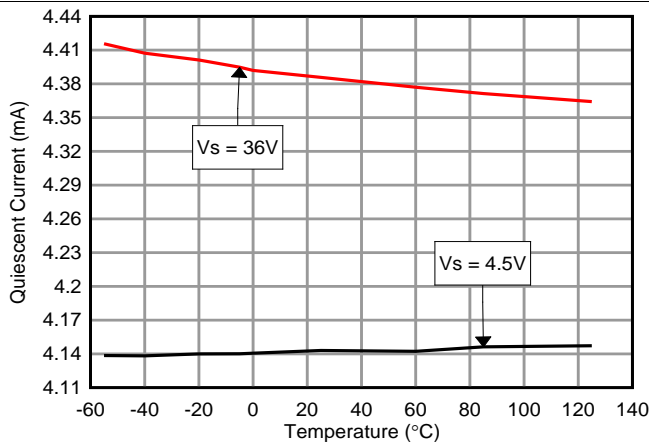

Figure 39. Quiescent Current vs Temperature

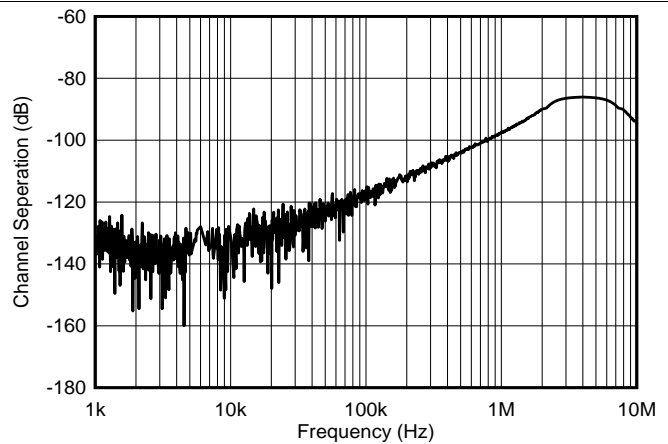

Figure 40. Channel Separation vs Frequency

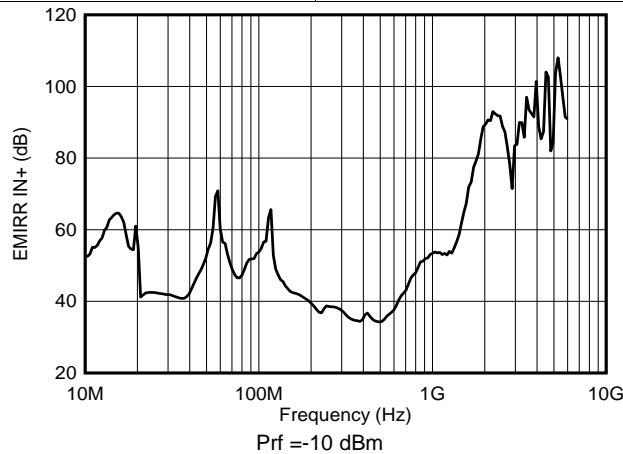

Figure 41. EMIRR vs Frequency

7 Detailed Description

7.1 Overview

The OPA2156 is laser trimmed to improve offset and uses a three-gain-stage architecture to achieve very low noise and distortion. The *Functional Block Diagram* shows a simplified schematic of the OPA2156 (one channel shown). The device consists of a low noise input stage and feed-forward pathway coupled to a high-current output stage. This topology exhibits superior distortion performance under a wide range of loading conditions compared to other operational amplifiers.

7.2 Functional Block Diagram

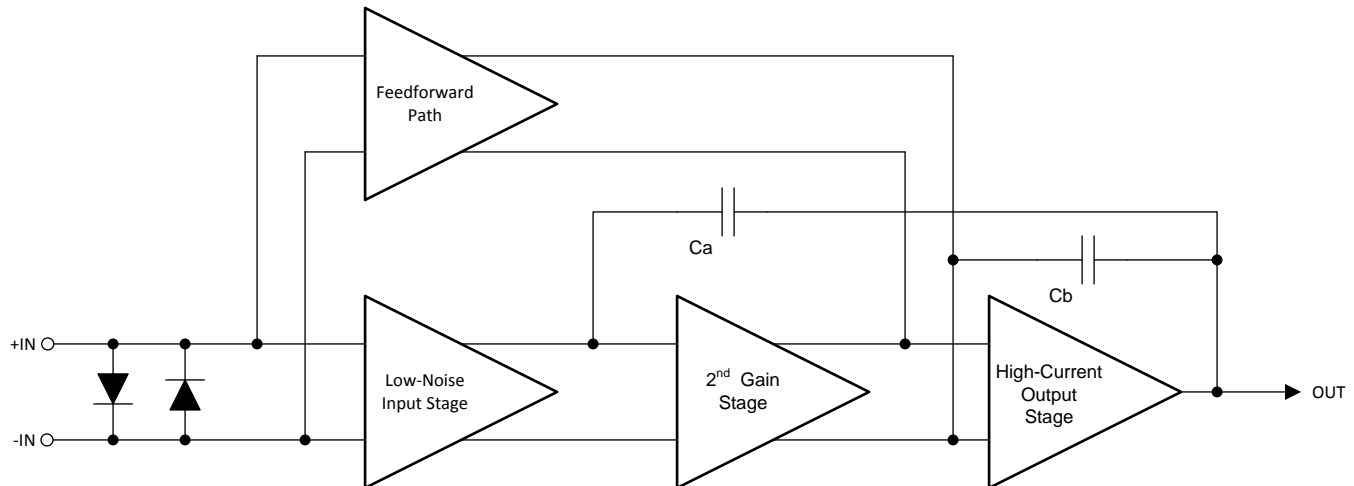

7.3 Feature Description

7.3.1 Phase Reversal Protection

The OPA2156 has internal phase-reversal protection. Many op amps exhibit phase reversal when the input is driven beyond the linear common-mode range. This condition is most often encountered in noninverting circuits when the input is driven beyond the specified common-mode voltage range, causing the output to reverse into the opposite rail. The input of the OPA2156 prevents phase reversal with excessive common-mode voltage. Instead, the appropriate rail limits the output voltage. This performance is shown in [Figure 42](#).

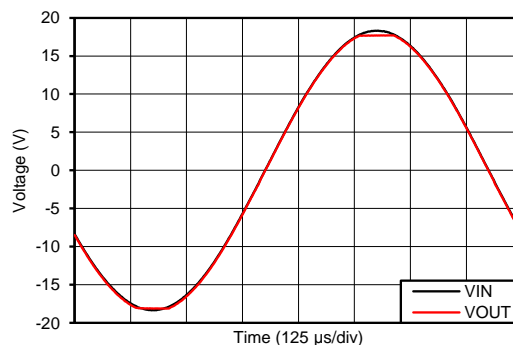

Figure 42. Output Waveform Devoid of Phase Reversal During an Input Overdrive Condition

Feature Description (continued)

7.3.2 Electrical Overstress

Designers often ask questions about the capability of an operational amplifier to withstand electrical overstress. These questions tend to focus on the device inputs, but can involve the supply voltage pins or even the output pin. Each of these different pin functions have electrical stress limits determined by the voltage breakdown characteristics of the particular semiconductor fabrication process and specific circuits connected to the pin. Additionally, internal electrostatic discharge (ESD) protection is built into these circuits to protect them from accidental ESD events both before and during product assembly.

A good understanding of this basic ESD circuitry and the relevance to an electrical overstress event is helpful. [Figure 43](#) illustrates the ESD circuits contained in the OPA2156 (indicated by the dashed line area). The ESD protection circuitry involves several current-steering diodes connected from the input and output pins and routed back to the internal power-supply lines, where the diodes meet at an absorption device internal to the operational amplifier. This protection circuitry is intended to remain inactive during normal circuit operation.

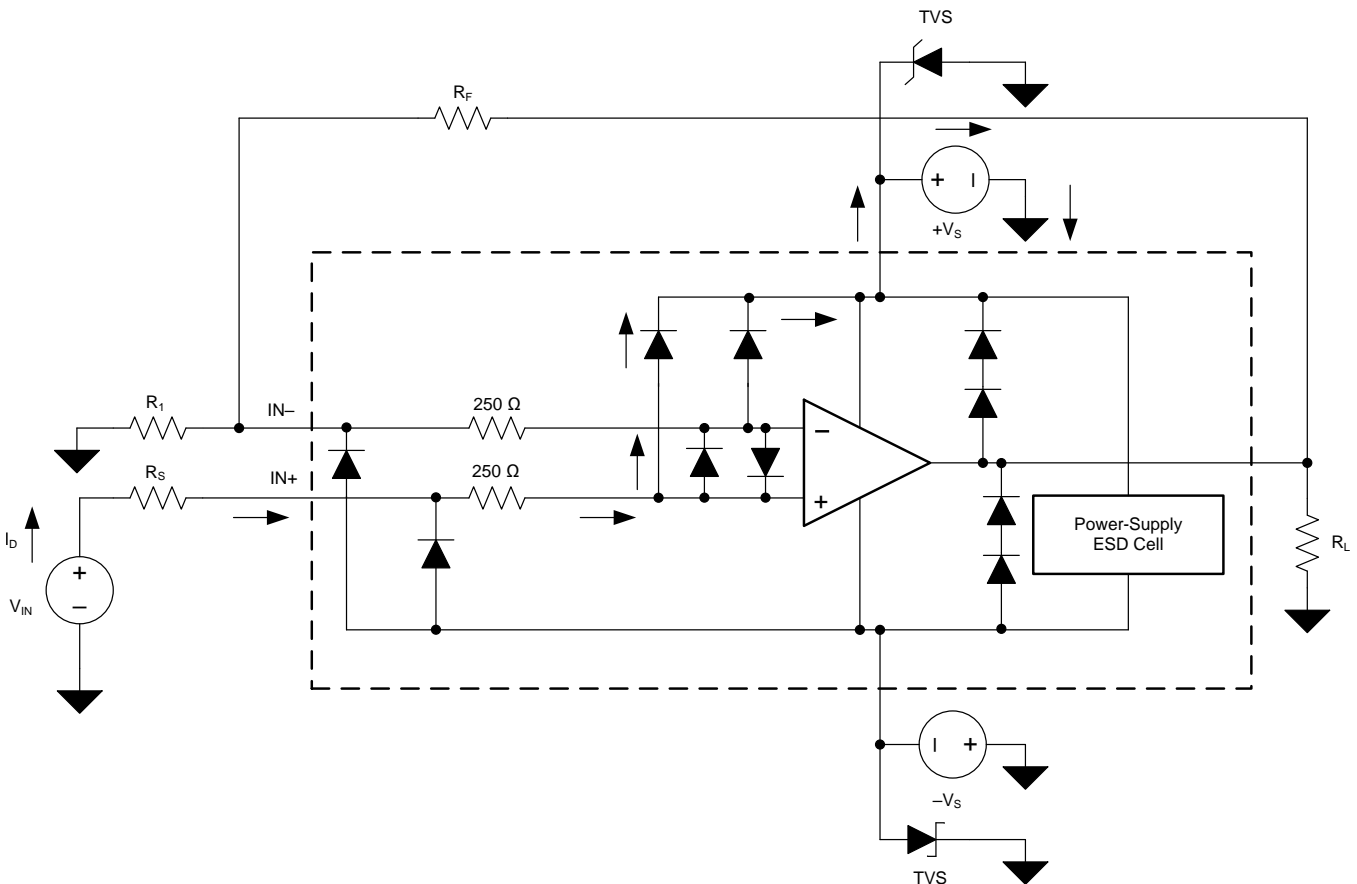

Figure 43. Equivalent Internal ESD Circuitry Relative to a Typical Circuit Application

An ESD event produces a short-duration, high-voltage pulse that is transformed into a short-duration, high-current pulse when discharging through a semiconductor device. The ESD protection circuits are designed to provide a current path around the operational amplifier core to prevent damage. The energy absorbed by the protection circuitry is then dissipated as heat.

When an ESD voltage develops across two or more amplifier device pins, current flows through one or more steering diodes. Depending on the path that the current takes, the absorption device can activate. The absorption device has a trigger, or threshold voltage, that is above the normal operating voltage of the OPA2156 but below the device breakdown voltage level. When this threshold is exceeded, the absorption device quickly activates and clamps the voltage across the supply rails to a safe level.

Feature Description (continued)

When the operational amplifier connects into a circuit (see [Figure 43](#)), the ESD protection components are intended to remain inactive and do not become involved in the application circuit operation. However, circumstances may arise where an applied voltage exceeds the operating voltage range of a given pin. If this condition occurs, there is a risk that some internal ESD protection circuits can turn on and conduct current. Any such current flow occurs through steering-diode paths and rarely involves the absorption device.

[Figure 43](#) shows a specific example where the input voltage (V_{IN}) exceeds the positive supply voltage ($V+$) by 500 mV or more. Much of what happens in the circuit depends on the supply characteristics. If $V+$ can sink the current, one of the upper input steering diodes conducts and directs current to $V+$. Excessively high current levels can flow with increasingly higher V_{IN} . As a result, the data sheet specifications recommend that applications limit the input current to 10 mA.

If the supply is not capable of sinking the current, V_{IN} can begin sourcing current to the operational amplifier and then take over as the source of positive supply voltage. The danger in this case is that the voltage can rise to levels that exceed the operational amplifier absolute maximum ratings.

Another common question involves what happens to the amplifier if an input signal is applied to the input when the power supplies ($V+$ or $V-$) are at 0 V. Again, this question depends on the supply characteristic when at 0 V, or at a level below the input signal amplitude. If the supplies appear as high impedance, then the input source supplies the operational amplifier current through the current-steering diodes. This state is not a normal bias condition; most likely, the amplifier does not operate normally. If the supplies are low impedance, then the current through the steering diodes can become quite high. The current level depends on the ability of the input source to deliver current, and any resistance in the input path.

If there is any uncertainty about the ability of the supply to absorb this current, add external Zener diodes to the supply pins; see [Figure 43](#). Select the Zener voltage so that the diode does not turn on during normal operation. However, the Zener voltage must be low enough so that the Zener diode conducts if the supply pin begins to rise above the safe-operating, supply-voltage level.

Feature Description (continued)

7.3.3 Thermal Considerations

Through normal operation the OPA2156 will experience self-heating, a natural increase in the die junction temperature which occurs in every amplifier. This is a result of several factors including the quiescent power consumption, the package’s thermal dissipation, PCB layout and the device operating conditions.

To fully ensure the amplifier will operate without entering thermal shutdown it is important to calculate the approximate junction (die) temperature which can be done using [Equation 1](#).

$$T_J = P_D * \Theta_{JA} + T_A \tag{1}$$

[Equation 2](#) shows the approximate junction temperature for the OPA2156 while unloaded with an ambient temperature of 25°C.

$$T_J = (36V * 4.4mA) * 120^\circ C / W + 25^\circ C$$

$$T_J = 44^\circ C \tag{2}$$

For high voltage, high precision amplifiers such as the OPA2156 the junction temperature can easily be 10s of degrees higher than the ambient temperature in a quiescent (unloaded) condition. If the device then begins to drive a heavy load the junction temperature may rise and trip the thermal shutdown circuit. The [Figure 44](#) shows the maximum output voltage of the OPA2156 without entering thermal shutdown vs ambient temperature in both a loaded and unloaded condition.

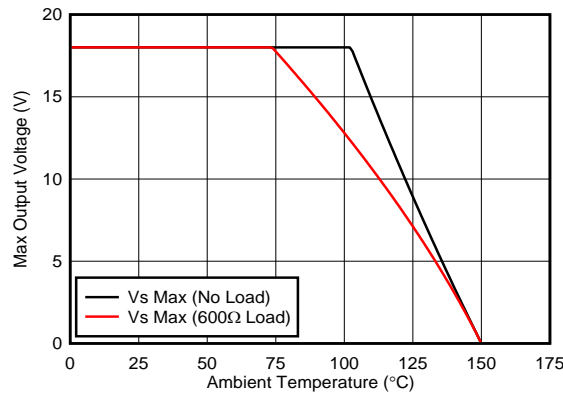

Figure 44. OPA2156 Thermal Safe Operating Area

Feature Description (continued)

7.3.4 Thermal Shutdown

The internal power dissipation of any amplifier causes the internal (junction) temperature to rise. This phenomenon is called *self heating*. The OPA2156 has a thermal protection feature that prevents damage from self heating.

This thermal protection works by monitoring the temperature of the output stage and turning off the op amp output drive for temperatures above approximately 170°C. Thermal protection forces the output to a high-impedance state. The OPA2156 is also designed with approximately 15°C of thermal hysteresis. Thermal hysteresis prevents the output stage from cycling in and out of the high-impedance state. The OPA2156 returns to normal operation when the output stage temperature falls below approximately 155°C.

The absolute maximum junction temperature of the OPA2156 is 150°C. Exceeding the limits shown in the [Absolute Maximum Ratings](#) table may cause damage to the device. Thermal protection triggers at 170°C because of unit-to-unit variance, but does not interfere with device operation up to the absolute maximum ratings. This thermal protection is not designed to prevent this device from exceeding absolute maximum ratings, but rather from excessive thermal overload.

7.3.5 Common-Mode Voltage Range

The OPA2156 is a 36-V, true rail-to-rail input operational amplifier with an input common-mode range that extends 100 mV beyond either supply rail. This wide range is achieved with paralleled complementary N-channel and P-channel differential input pairs. The N-channel pair is active for input voltages close to the positive rail, typically $(V+) - 2.25\text{ V}$ to 100 mV above the positive supply. The P-channel pair is active for inputs from 100 mV below the negative supply to approximately $(V+) - 1.25\text{ V}$. There is a small transition region, typically $(V+) - 2.25\text{ V}$ to $(V+) - 1.25\text{ V}$ in which both input pairs are active. This transition region varies modestly with process variation. Within this region PSRR, CMRR, offset voltage, offset drift, noise, and THD performance are degraded compared to operation outside this region.

To achieve the best performance for two-stage rail-to-rail input amplifiers, avoid the transition region when possible. The OPA2156 uses a precision trim for both the N-channel and P-channel regions. This technique enables significantly lower levels of offset than previous-generation devices, causing variance in the transition region of the input stages to appear exaggerated relative to offset over the full common-mode range.

7.3.6 Overload Recovery

Overload recovery is defined as the time required for the op amp output to recover from a saturated state to a linear state. The output devices of the op amp enter a saturation region when the output voltage exceeds the rated operating voltage, either due to the high input voltage or the high gain. After the device enters the saturation region, the charge carriers in the output devices require time to return back to the linear state. After the charge carriers return back to the linear state, the device begins to slew at the specified slew rate. Thus, the propagation delay in case of an overload condition is the sum of the overload recovery time and the slew time.

7.4 Device Functional Modes

The OPA2156 has a single functional mode and is operational when the power-supply voltage is greater than 4.5 V ($\pm 2.25\text{ V}$). The maximum power supply voltage for the OPA2156 is 36 V ($\pm 18\text{ V}$).

8 Application and Implementation

NOTE

Information in the following applications sections is not part of the TI component specification, and TI does not warrant its accuracy or completeness. TI's customers are responsible for determining suitability of components for their purposes. Customers should validate and test their design implementation to confirm system functionality.

8.1 Application Information

The OPA2156 offers excellent dc precision and ac performance. The device operates with up to 36-V supply rails offering true rail-to-rail input/output, low offset voltage and offset voltage drift, as well as 25-MHz bandwidth and low input bias. These features make the OPA2156 a robust, high-performance operational amplifier for high-voltage industrial applications.

8.1.1 Slew Rate Limit for Input Protection

In control systems for valves or motors, abrupt changes in voltages or currents can cause mechanical damages. By controlling the slew rate of the command voltages into the drive circuits, the load voltages ramps up and down at a safe rate. For symmetrical slew-rate applications (positive slew rate equals negative slew rate), one additional op amp provides slew-rate control for a given analog gain stage. The unique input protection and high output current and slew rate of the OPA2156 make the device an optimal amplifier to achieve slew rate control for both dual- and single-supply systems. [Figure 45](#) shows the OPA2156 in a slew-rate limit design.

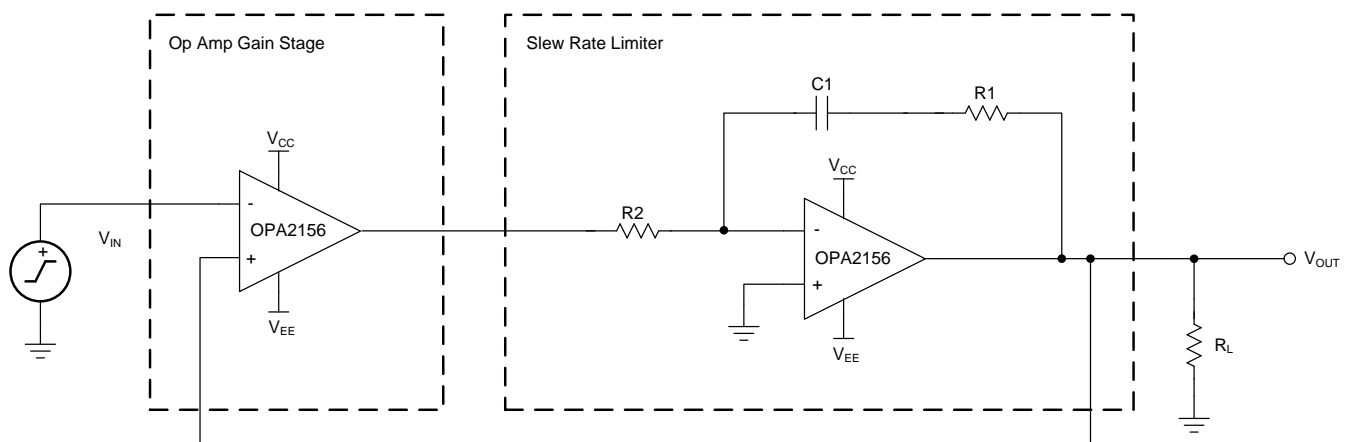

Figure 45. Slew Rate Limiter Uses One Op Amp



For step-by-step design procedure, circuit schematics, bill of materials, PCB files, simulation results, and test results, refer to [TI Precision Design TIDU026, Slew Rate Limiter Uses One Op Amp](#).

8.2 Typical Application

The combination of low input bias, high slew rate and a rail-to-rail input and output enable the OPA2156 to serve as an accurate differential photodiode transimpedance amplifier. This application example shows the design of such a system.

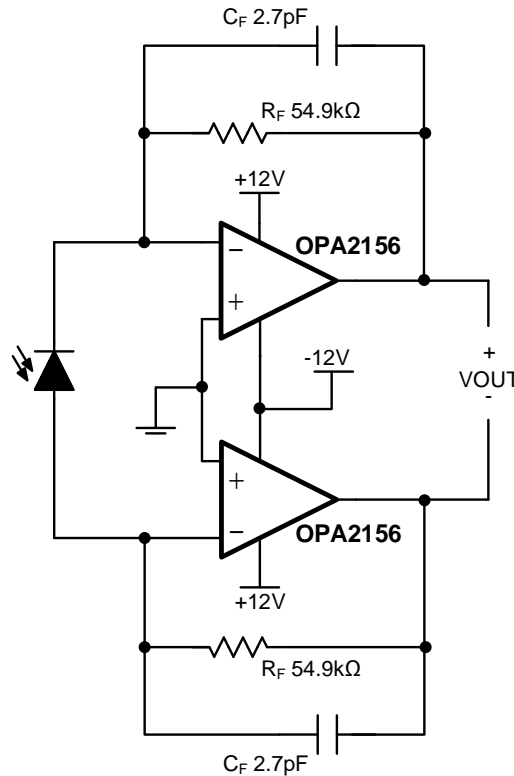

Figure 46. OPA2156 Configured as a Differential Photodiode Transimpedance Amplifier

8.2.1 Design Requirements

The design requirements for this design are:

- Photodiode current: 0 μA to 90 μA
- Output voltage: -5 V to 5 V
- Supply voltage: $\pm 12\text{ V}$
- Filter cutoff frequency: 1 MHz

8.2.2 Detailed Design Procedure

In this example the OPA2156 serves as a transimpedance amplifier for a differential photodiode. The differential configuration allows for a wider output range (0 to 10-V differential) compared to a single-ended configuration (0 V to 5 V). This output can be connected to a differential successive approximation register (SAR) analog-to-digital converter (ADC). The basic equation for a differential transimpedance amplifier output voltage is shown in Equation 3.

$$V_{\text{OUT}} = I_{\text{PD}} \times 2 \times R_{\text{F}} \quad (3)$$

Equation 3 can be rearranged to calculate the value of the feedback resistors as shown in Equation 4.

Typical Application (continued)

$$\frac{V_{OUT(MAX)} - V_{OUT(MIN)}}{2 \times I_{IN(MAX)}} \leq R_F$$

$$\frac{5V - (-5V)}{2 \times 90\mu A} \leq 55.6k\Omega \tag{4}$$

Adding a capacitor to the feedback loop creates a filter which will remove undesired noise beyond its cutoff frequency. For this application a 1-MHz cutoff frequency was selected. The equation for an RC filter is provided in Equation 5.

$$f_c = \frac{1}{2 \times \pi \times R_F \times C_F} \tag{5}$$

Rearranging this equation to solve for the capacitor value is show in Equation 6.

$$C_F \leq \frac{1}{2 \times \pi \times 54k\Omega \times 1MHz} \leq 2.7 pF \tag{6}$$

For more information on photodiode transimpedance amplifier system design and for a single-ended example, see [TIDU535: 1 MHz, Single-Supply, Photodiode Amplifier Reference Design](#).

8.2.3 Application Curves

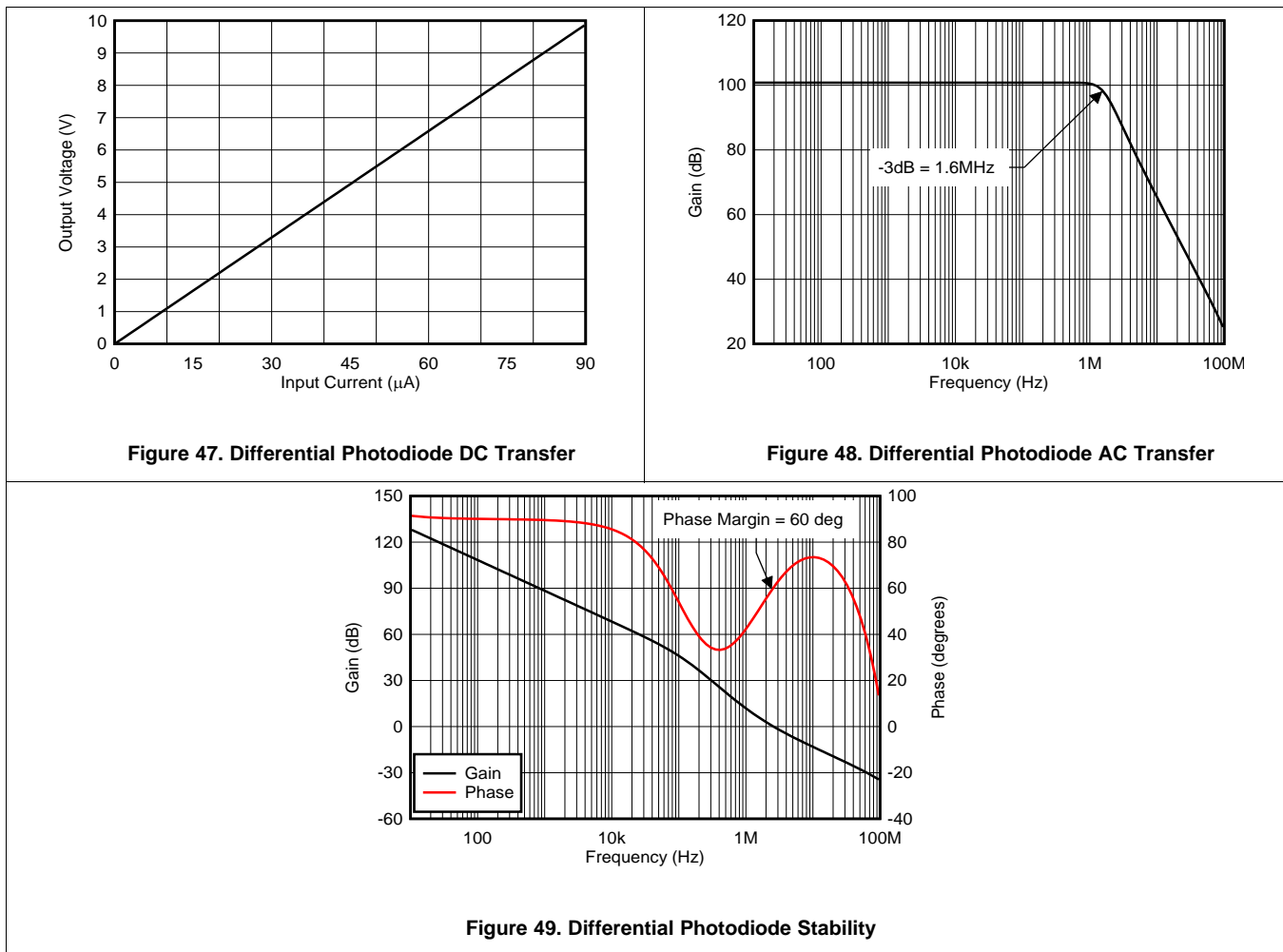

9 Power Supply Recommendations

The OPA2156 is specified for operation from 4.5 V to 36 V (± 2.25 V to ± 18 V); many specifications apply from -40°C to 125°C . Parameters that can exhibit significant variance with regard to operating voltage or temperature are presented in the [Typical Characteristics](#).

CAUTION

Supply voltages larger than 40 V can permanently damage the device; see the [Absolute Maximum Ratings](#).

10 Layout

10.1 Layout Guidelines

For best operational performance of the device, use good PCB layout practices, including:

- Connect low-ESR, 0.1- μF ceramic bypass capacitors between each supply pin and ground, placed as close as possible to the device. A single bypass capacitor from $V+$ to ground is applicable for single-supply applications.
 - Noise can propagate into analog circuitry through the power pins of the circuit as a whole and op amp itself. Bypass capacitors are used to reduce the coupled noise by providing low-impedance power sources local to the analog circuitry.
- Make sure to physically separate digital and analog grounds paying attention to the flow of the ground current. Separate grounding for analog and digital portions of circuitry is one of the simplest and most-effective methods of noise suppression. One or more layers on multilayer PCBs are usually devoted to ground planes. A ground plane helps distribute heat and reduces EMI noise pickup.
- In order to reduce parasitic coupling, run the input traces as far away as possible from the supply or output traces. If these traces cannot be kept separate, crossing the sensitive trace perpendicular is much better as opposed to in parallel with the noisy trace.
- Place the external components as close to the device as possible. As shown in [Figure 50](#), keeping RF and RG close to the inverting input minimizes parasitic capacitance.
- Keep the length of input traces as short as possible. Always remember that the input traces are the most sensitive part of the circuit.
- Consider a driven, low-impedance guard ring around the critical traces. A guard ring can significantly reduce leakage currents from nearby traces that are at different potentials.
- Clean the PCB following board assembly for best performance.
- Any precision integrated circuit may experience performance shifts due to moisture ingress into the plastic package. After any aqueous PCB cleaning process, bake the PCB assembly to remove moisture introduced into the device packaging during the cleaning process. A low-temperature, post-cleaning bake at 85°C for 30 minutes is sufficient for most circumstances.

10.1.1 Power Dissipation

The OPA2156 op amp is capable of driving a variety of loads with a power-supply voltage up to ± 18 V and full operating temperature range. Internal power dissipation increases when operating at high supply voltages and/or high output currents. Copper leadframe construction used in the OPA2156 improves heat dissipation compared to conventional materials. Circuit board layout can also help minimize junction temperature rise. Wide copper traces help dissipate the heat by acting as an additional heat sink. Temperature rise can be further minimized by soldering the devices to the circuit board rather than using a socket.

Layout Guidelines (continued)

The OPA2156 has an internal thermal protection feature which prevents it from being damaged due to self heating, or the internal heating generated during normal operation. The protection circuitry works by monitoring the temperature of the output stage and turns off the output drive if the junction temperature of the device rises to approximately 170°C. The device has a thermal hysteresis of approximately 15°C, which allows the device to safely cool down before returning to normal operation at approximately 155°C. TI recommends that the system design takes into account the thermal dissipation of the OPA2156 to ensure that the recommended operating junction temperature of 125°C is not exceeded to avoid decreasing the lifespan of the device or permanently damaging the amplifier.

10.2 Layout Example

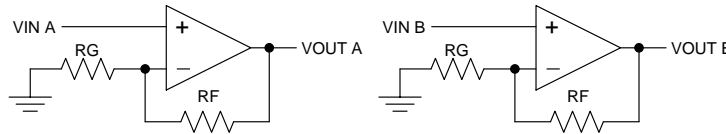

(Schematic Representation)

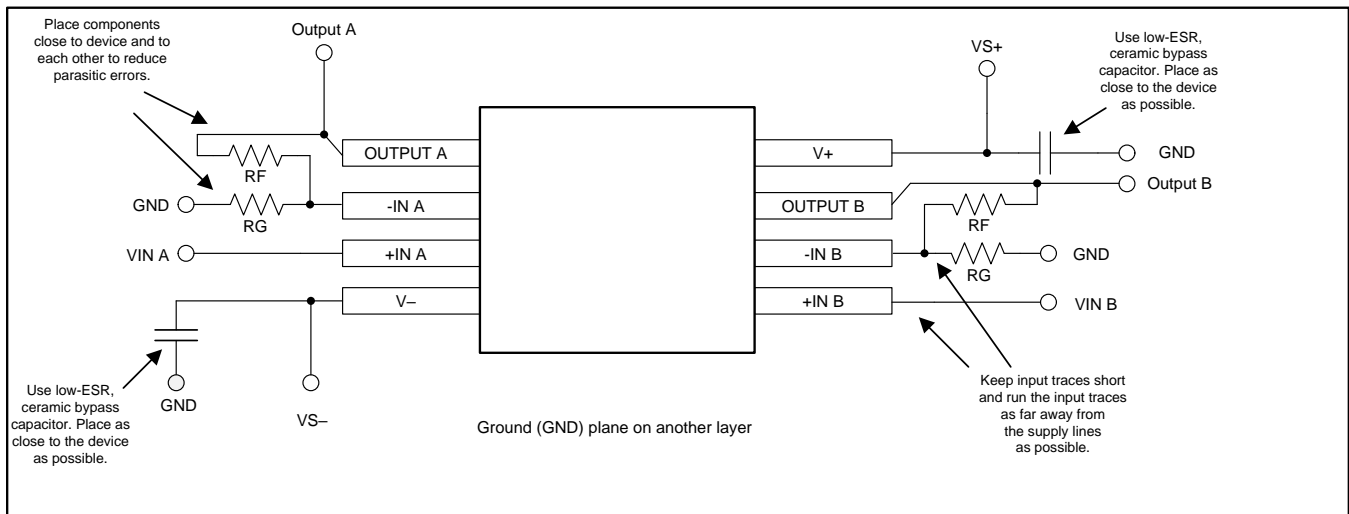

Figure 50. Operational Amplifier Board Layout for Noninverting Configuration

11 Device and Documentation Support

11.1 Device Support

11.1.1 Development Support

11.1.1.1 TINA-TI™ (Free Software Download)

TINA™ is a simple, powerful, and easy-to-use circuit simulation program based on a SPICE engine. TINA-TI is a free, fully-functional version of the TINA software, preloaded with a library of macro models in addition to a range of both passive and active models. TINA-TI provides all the conventional dc, transient, and frequency domain analysis of SPICE, as well as additional design capabilities.

Available as a [free download](#) from the Analog eLab Design Center, TINA-TI offers extensive post-processing capability that allows users to format results in a variety of ways. Virtual instruments offer the ability to select input waveforms and probe circuit nodes, voltages, and waveforms, creating a dynamic quick-start tool.

NOTE

These files require that either the TINA software (from DesignSoft™) or TINA-TI software be installed. Download the free TINA-TI software from the [TINA-TI folder](#) at <http://www.ti.com/tool/tina-ti>.

11.1.1.2 TI Precision Designs

TI Precision Designs, available online at <http://www.ti.com/ww/en/analog/precision-designs/>, are analog solutions created by TI's precision analog applications experts and offer the theory of operation, component selection, simulation, complete PCB schematic and layout, bill of materials, and measured performance of many useful circuits.

11.2 Documentation Support

11.2.1 Related Documentation

- Texas Instruments, [EMI Rejection Ratio of Operational Amplifiers application report](#)
- Texas Instruments, [0-1A, Single-Supply, Low-Side, Current Sensing Solution reference design](#)
- Texas Instruments, [Op Amps for Everyone design reference](#)

11.3 Receiving Notification of Documentation Updates

To receive notification of documentation updates, navigate to the device product folder on ti.com. In the upper right corner, click on *Alert me* to register and receive a weekly digest of any product information that has changed. For change details, review the revision history included in any revised document.

11.4 Community Resources

The following links connect to TI community resources. Linked contents are provided "AS IS" by the respective contributors. They do not constitute TI specifications and do not necessarily reflect TI's views; see TI's [Terms of Use](#).

TI E2E™ Online Community *TI's Engineer-to-Engineer (E2E) Community*. Created to foster collaboration among engineers. At e2e.ti.com, you can ask questions, share knowledge, explore ideas and help solve problems with fellow engineers.

Design Support *TI's Design Support* Quickly find helpful E2E forums along with design support tools and contact information for technical support.

11.5 Trademarks

E2E is a trademark of Texas Instruments.

TINA-TI is a trademark of Texas Instruments, Inc and DesignSoft, Inc.

TINA, DesignSoft are trademarks of DesignSoft, Inc.

All other trademarks are the property of their respective owners.

11.6 Electrostatic Discharge Caution



This integrated circuit can be damaged by ESD. Texas Instruments recommends that all integrated circuits be handled with appropriate precautions. Failure to observe proper handling and installation procedures can cause damage.

ESD damage can range from subtle performance degradation to complete device failure. Precision integrated circuits may be more susceptible to damage because very small parametric changes could cause the device not to meet its published specifications.

11.7 Glossary

[SLYZ022](#) — *TI Glossary*.

This glossary lists and explains terms, acronyms, and definitions.

12 Mechanical, Packaging, and Orderable Information

The following pages include mechanical, packaging, and orderable information. This information is the most current data available for the designated devices. This data is subject to change without notice and revision of this document. For browser-based versions of this data sheet, refer to the left-hand navigation.

PACKAGING INFORMATION

Orderable Device	Status (1)	Package Type	Package Drawing	Pins	Package Qty	Eco Plan (2)	Lead finish/ Ball material (6)	MSL Peak Temp (3)	Op Temp (°C)	Device Marking (4/5)	Samples
OPA2156ID	ACTIVE	SOIC	D	8	75	RoHS & Green	NIPDAU	Level-2-260C-1 YEAR	-40 to 125	OP2156	Samples
OPA2156IDGKR	ACTIVE	VSSOP	DGK	8	2500	RoHS & Green	NIPDAUAG	Level-2-260C-1 YEAR	-40 to 125	1THV	Samples
OPA2156IDGKT	ACTIVE	VSSOP	DGK	8	250	RoHS & Green	NIPDAUAG	Level-2-260C-1 YEAR	-40 to 125	1THV	Samples
OPA2156IDR	ACTIVE	SOIC	D	8	2500	RoHS & Green	NIPDAU	Level-2-260C-1 YEAR	-40 to 125	OP2156	Samples

(1) The marketing status values are defined as follows:

ACTIVE: Product device recommended for new designs.

LIFEBUY: TI has announced that the device will be discontinued, and a lifetime-buy period is in effect.

NRND: Not recommended for new designs. Device is in production to support existing customers, but TI does not recommend using this part in a new design.

PREVIEW: Device has been announced but is not in production. Samples may or may not be available.

OBSELETE: TI has discontinued the production of the device.

(2) **RoHS:** TI defines "RoHS" to mean semiconductor products that are compliant with the current EU RoHS requirements for all 10 RoHS substances, including the requirement that RoHS substance do not exceed 0.1% by weight in homogeneous materials. Where designed to be soldered at high temperatures, "RoHS" products are suitable for use in specified lead-free processes. TI may reference these types of products as "Pb-Free".

RoHS Exempt: TI defines "RoHS Exempt" to mean products that contain lead but are compliant with EU RoHS pursuant to a specific EU RoHS exemption.

Green: TI defines "Green" to mean the content of Chlorine (Cl) and Bromine (Br) based flame retardants meet JS709B low halogen requirements of <=1000ppm threshold. Antimony trioxide based flame retardants must also meet the <=1000ppm threshold requirement.

(3) MSL, Peak Temp. - The Moisture Sensitivity Level rating according to the JEDEC industry standard classifications, and peak solder temperature.

(4) There may be additional marking, which relates to the logo, the lot trace code information, or the environmental category on the device.

(5) Multiple Device Markings will be inside parentheses. Only one Device Marking contained in parentheses and separated by a "-" will appear on a device. If a line is indented then it is a continuation of the previous line and the two combined represent the entire Device Marking for that device.

(6) Lead finish/Ball material - Orderable Devices may have multiple material finish options. Finish options are separated by a vertical ruled line. Lead finish/Ball material values may wrap to two lines if the finish value exceeds the maximum column width.

Important Information and Disclaimer:The information provided on this page represents TI's knowledge and belief as of the date that it is provided. TI bases its knowledge and belief on information provided by third parties, and makes no representation or warranty as to the accuracy of such information. Efforts are underway to better integrate information from third parties. TI has taken and

continues to take reasonable steps to provide representative and accurate information but may not have conducted destructive testing or chemical analysis on incoming materials and chemicals. TI and TI suppliers consider certain information to be proprietary, and thus CAS numbers and other limited information may not be available for release.

In no event shall TI's liability arising out of such information exceed the total purchase price of the TI part(s) at issue in this document sold by TI to Customer on an annual basis.

TAPE AND REEL INFORMATION



QUADRANT ASSIGNMENTS FOR PIN 1 ORIENTATION IN TAPE



*All dimensions are nominal

Device	Package Type	Package Drawing	Pins	SPQ	Reel Diameter (mm)	Reel Width W1 (mm)	A0 (mm)	B0 (mm)	K0 (mm)	P1 (mm)	W (mm)	Pin1 Quadrant
OPA2156IDGKR	VSSOP	DGK	8	2500	330.0	12.4	5.3	3.4	1.4	8.0	12.0	Q1
OPA2156IDGKT	VSSOP	DGK	8	250	330.0	12.4	5.3	3.4	1.4	8.0	12.0	Q1
OPA2156IDR	SOIC	D	8	2500	330.0	12.4	6.4	5.2	2.1	8.0	12.0	Q1

TAPE AND REEL BOX DIMENSIONS

*All dimensions are nominal

Device	Package Type	Package Drawing	Pins	SPQ	Length (mm)	Width (mm)	Height (mm)
OPA2156IDGKR	VSSOP	DGK	8	2500	366.0	364.0	50.0
OPA2156IDGKT	VSSOP	DGK	8	250	366.0	364.0	50.0
OPA2156IDR	SOIC	D	8	2500	853.0	449.0	35.0



D0008A

PACKAGE OUTLINE

SOIC - 1.75 mm max height

SMALL OUTLINE INTEGRATED CIRCUIT



4214825/C 02/2019

NOTES:

1. Linear dimensions are in inches [millimeters]. Dimensions in parenthesis are for reference only. Controlling dimensions are in inches. Dimensioning and tolerancing per ASME Y14.5M.
2. This drawing is subject to change without notice.
3. This dimension does not include mold flash, protrusions, or gate burrs. Mold flash, protrusions, or gate burrs shall not exceed $.006$ [0.15] per side.
4. This dimension does not include interlead flash.
5. Reference JEDEC registration MS-012, variation AA.

EXAMPLE BOARD LAYOUT

D0008A

SOIC - 1.75 mm max height

SMALL OUTLINE INTEGRATED CIRCUIT



LAND PATTERN EXAMPLE
 EXPOSED METAL SHOWN
 SCALE:8X



SOLDER MASK DETAILS

4214825/C 02/2019

NOTES: (continued)

- 6. Publication IPC-7351 may have alternate designs.
- 7. Solder mask tolerances between and around signal pads can vary based on board fabrication site.

EXAMPLE STENCIL DESIGN

D0008A

SOIC - 1.75 mm max height

SMALL OUTLINE INTEGRATED CIRCUIT



SOLDER PASTE EXAMPLE
BASED ON .005 INCH [0.125 MM] THICK STENCIL
SCALE:8X

4214825/C 02/2019

NOTES: (continued)

8. Laser cutting apertures with trapezoidal walls and rounded corners may offer better paste release. IPC-7525 may have alternate design recommendations.
9. Board assembly site may have different recommendations for stencil design.

DGK (S-PDSO-G8)

PLASTIC SMALL-OUTLINE PACKAGE



- NOTES:
- A. All linear dimensions are in millimeters.
 - B. This drawing is subject to change without notice.
 - C. Body length does not include mold flash, protrusions, or gate burrs. Mold flash, protrusions, or gate burrs shall not exceed 0.15 per end.
 - D. Body width does not include interlead flash. Interlead flash shall not exceed 0.50 per side.
 - E. Falls within JEDEC MO-187 variation AA, except interlead flash.



- NOTES:
- A. All linear dimensions are in millimeters.
 - B. This drawing is subject to change without notice.
 - C. Publication IPC-7351 is recommended for alternate designs.
 - D. Laser cutting apertures with trapezoidal walls and also rounding corners will offer better paste release. Customers should contact their board assembly site for stencil design recommendations. Refer to IPC-7525 for other stencil recommendations.
 - E. Customers should contact their board fabrication site for solder mask tolerances between and around signal pads.

IMPORTANT NOTICE AND DISCLAIMER

TI PROVIDES TECHNICAL AND RELIABILITY DATA (INCLUDING DATASHEETS), DESIGN RESOURCES (INCLUDING REFERENCE DESIGNS), APPLICATION OR OTHER DESIGN ADVICE, WEB TOOLS, SAFETY INFORMATION, AND OTHER RESOURCES "AS IS" AND WITH ALL FAULTS, AND DISCLAIMS ALL WARRANTIES, EXPRESS AND IMPLIED, INCLUDING WITHOUT LIMITATION ANY IMPLIED WARRANTIES OF MERCHANTABILITY, FITNESS FOR A PARTICULAR PURPOSE OR NON-INFRINGEMENT OF THIRD PARTY INTELLECTUAL PROPERTY RIGHTS.

These resources are intended for skilled developers designing with TI products. You are solely responsible for (1) selecting the appropriate TI products for your application, (2) designing, validating and testing your application, and (3) ensuring your application meets applicable standards, and any other safety, security, or other requirements. These resources are subject to change without notice. TI grants you permission to use these resources only for development of an application that uses the TI products described in the resource. Other reproduction and display of these resources is prohibited. No license is granted to any other TI intellectual property right or to any third party intellectual property right. TI disclaims responsibility for, and you will fully indemnify TI and its representatives against, any claims, damages, costs, losses, and liabilities arising out of your use of these resources.

TI's products are provided subject to TI's Terms of Sale (www.ti.com/legal/termsofsale.html) or other applicable terms available either on ti.com or provided in conjunction with such TI products. TI's provision of these resources does not expand or otherwise alter TI's applicable warranties or warranty disclaimers for TI products.

Mailing Address: Texas Instruments, Post Office Box 655303, Dallas, Texas 75265
Copyright © 2020, Texas Instruments Incorporated