

ADS855x

16-, 14-, 12-Bit, Six-Channel, Simultaneous Sampling Analog-to-Digital Converters

1 Features

- Family of 16-, 14-, 12-Bit, Pin- and Software-Compatible ADCs
- Six SAR ADCs Grouped in Three Pairs
- Maximum Data Rate Per Channel with Internal Conversion Clock and Reference:
 - ADS8556: 630 kSPS (PAR) or 450 kSPS (SER)
 - ADS8557: 670 kSPS (PAR) or 470 kSPS (SER)
 - ADS8558: 730 kSPS (PAR) or 500 kSPS (SER)
- Maximum Data Rate with External Conversion Clock and Reference:
 - 800 kSPS (PAR) or 530 kSPS (SER)
- Pin-Selectable or Programmable Input Voltage Ranges: Up to ± 12 V
- Excellent Signal-to-Noise Performance:
 - ADS8556: 91.5 dB, ADS8667: 85 dB, ADS8668: 73.9 dB
- Programmable and Buffered Internal Reference:
 - 0.5 V to 2.5 V and 0.5 V to 3.0 V
- Comprehensive Power-Down Modes:
 - Deep Power-Down (Standby Mode)
 - Partial Power-Down
 - Auto-Nap Power-Down
- Selectable Parallel or Serial Interface
- Operating Temperature Range: -40°C to 125°C

2 Applications

- Power Quality Measurement
- Protection Relays
- Multi-Axis Motor Control
- Programmable Logic Controllers
- Industrial Data Acquisition

3 Description

The ADS855x contains six low-power, 16-, 14-, or 12-bit, successive approximation register (SAR) based analog-to-digital converters (ADCs) with true bipolar inputs. Each channel contains a sample-and-hold circuit that allows simultaneous high-speed multi-channel signal acquisition.

The ADS855x supports data rates of up to 730 kSPS in parallel interface mode or up to 500 kSPS if the serial interface is used. The bus width of the parallel interface can be set to eight or 16 bits. In serial mode, up to three output channels can be activated.

The ADS855x is specified over the full industrial temperature range of -40°C to 125°C and is available in an LQFP-64 package.

Device Information⁽¹⁾

PART NUMBER	PACKAGE	BODY SIZE (NOM)
ADS8556	LQFP (64)	10.00 mm x 10.00 mm
ADS8557		
ADS8558		

(1) For all available packages, see the orderable addendum at the end of the data sheet.

Block Diagram

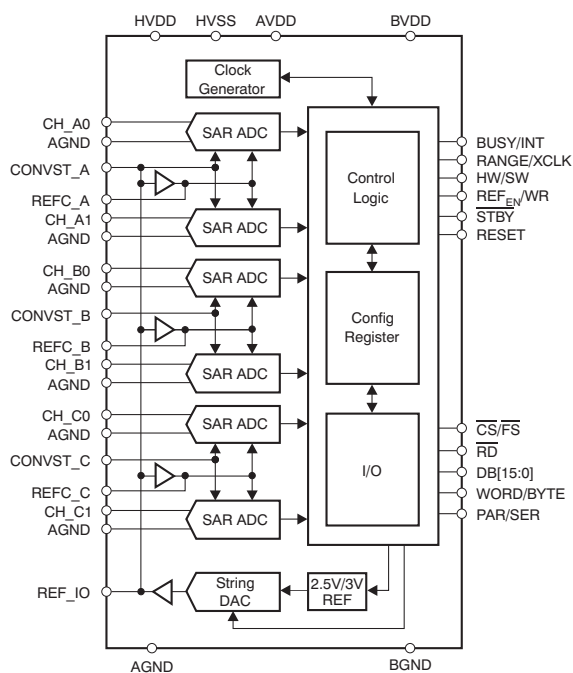

SNR vs Temperature

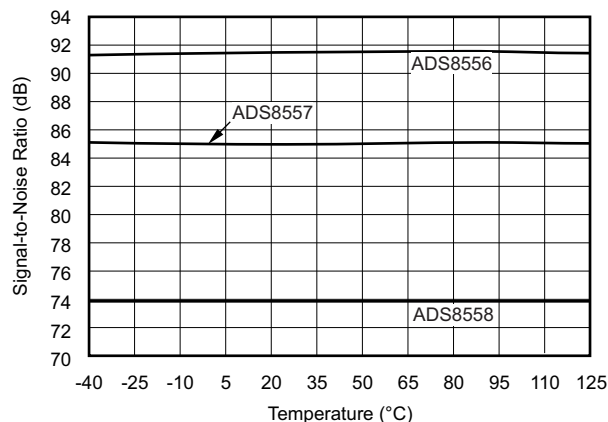

Table of Contents

<p>1 Features 1</p> <p>2 Applications 1</p> <p>3 Description 1</p> <p>4 Revision History..... 2</p> <p>5 Pin Configuration and Functions 3</p> <p>6 Specifications..... 7</p> <p> 6.1 Absolute Maximum Ratings 7</p> <p> 6.2 ESD Ratings..... 7</p> <p> 6.3 Recommended Operating Conditions..... 8</p> <p> 6.4 Thermal Information 8</p> <p> 6.5 Electrical Characteristics: General 8</p> <p> 6.6 Electrical Characteristics: ADS8556 11</p> <p> 6.7 Electrical Characteristics: ADS8557 12</p> <p> 6.8 Electrical Characteristics: ADS8558 13</p> <p> 6.9 Power Dissipation Characteristics 13</p> <p> 6.10 Serial Interface Timing Requirements 14</p> <p> 6.11 Parallel Interface Timing Requirements (Read Access) 14</p> <p> 6.12 Parallel Interface Timing Requirements (Write Access) 15</p> <p> 6.13 Typical Characteristics 17</p> <p>7 Detailed Description 23</p>	<p> 7.1 Overview 23</p> <p> 7.2 Functional Block Diagram 23</p> <p> 7.3 Feature Description..... 24</p> <p> 7.4 Device Functional Modes..... 28</p> <p> 7.5 Register Maps 32</p> <p>8 Application and Implementation 35</p> <p> 8.1 Application Information..... 35</p> <p> 8.2 Typical Application 35</p> <p>9 Power Supply Recommendations 39</p> <p>10 Layout..... 39</p> <p> 10.1 Layout Guidelines 39</p> <p> 10.2 Layout Example 40</p> <p>11 Device and Documentation Support 41</p> <p> 11.1 Documentation Support 41</p> <p> 11.2 Related Links 41</p> <p> 11.3 Community Resources..... 41</p> <p> 11.4 Trademarks 41</p> <p> 11.5 Electrostatic Discharge Caution..... 41</p> <p> 11.6 Glossary 41</p> <p>12 Mechanical, Packaging, and Orderable Information 41</p>
--	---

4 Revision History

NOTE: Page numbers for previous revisions may differ from page numbers in the current version.

Changes from Revision C (November 2015) to Revision D	Page
• Moved <i>Electrical Characteristics: General</i> table to before other Electrical Characteristics tables.....	8
• Added text reference for Figure 42	32
• Changed Figure 43 : changed capacitor values from 820 nF to 820 pF.....	36

Changes from Revision B (January 2012) to Revision C	Page
• Added <i>ESD Ratings</i> table, <i>Feature Description</i> section, <i>Device Functional Modes</i> , <i>Application and Implementation</i> section, <i>Power Supply Recommendations</i> section, <i>Layout</i> section, <i>Device and Documentation Support</i> section, and <i>Mechanical, Packaging, and Orderable Information</i> section.	1

Changes from Revision A (August 2009) to Revision B	Page
• Changed unit column for all t_{CONV} rows in the Serial Interface Timing Requirements table.....	14
• Added t_{S3} row to Serial Interface Timing Requirements table.....	14
• Changed unit column for all t_{CONV} rows in Parallel Interface Timing Requirements (Read Access) table	14
• Updated Figure 2	15
• Updated Figure 3	16
• Changed second paragraph of <i>CONVST_x</i> section.....	25
• Changed minimum bandwidth value in last sentence of <i>Reference</i> section.....	26
• Updated Figure 38	29

5 Pin Configuration and Functions

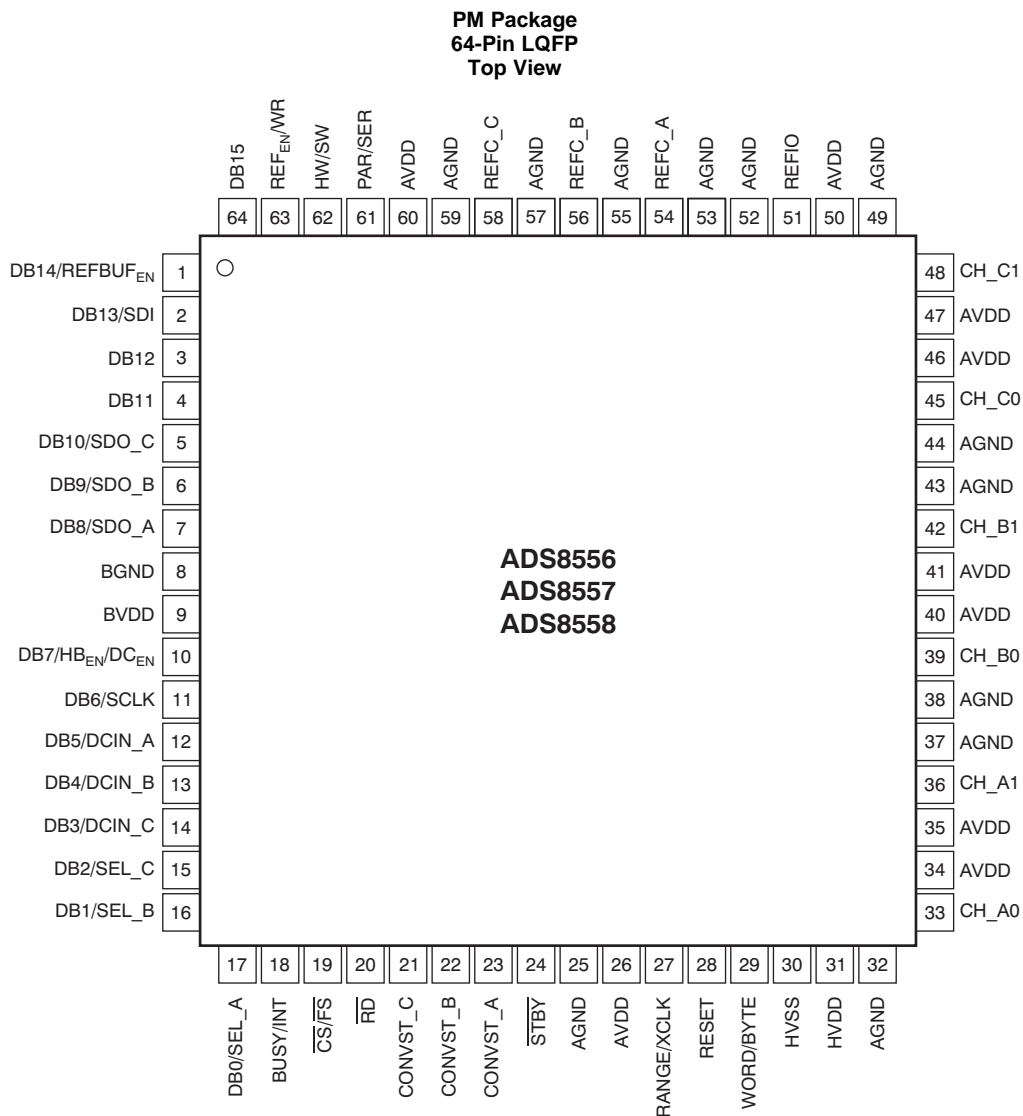

Pin Functions

PIN		TYPE ⁽¹⁾	DESCRIPTION	
NAME	NO.		PARALLEL INTERFACE (PAR/SER = 0)	SERIAL INTERFACE (PAR/SER = 1)
DB14/REFBUF _{EN}	1	DIO, DI	Data bit 14 input/output Output is '0' for the ADS8557, ADS8558	Hardware mode (HW/SW = 0): Reference buffers enable input. When low, all reference buffers are enabled (mandatory if internal reference is used). When high, all reference buffers are disabled. Software mode (HW/SW = 1): Connect to BGND or BVDD. The reference buffers are controlled by bit C24 (REFBUF) in control register (CR).
DB13/SDI	2	DIO, DI	Data bit 13 input/output Output is MSB for the ADS8557 and '0' for the ADS8558	Hardware mode (HW/SW = 0): Connect to BGND Software mode (HW/SW = 1): Serial data input
DB12	3	DIO	Data bit 12 input/output Output is '0' for the ADS8558	Connect to BGND
DB11	4	DIO	Data bit 11 input/output Output is MSB for the ADS8558	Connect to BGND
DB10/SDO _C	5	DIO, DO	Data bit 10 input/output	When SEL _C = 1, data output for channel C When SEL _C = 0, tie this pin to BGND
DB9/SDO _B	6	DIO, DO	Data bit 9 input/output	When SEL _B = 1, data output for channel B When SEL _B = 0, tie this pin to BGND When SEL _C = 0, data from channel C1 are also available on this output
DB8/SDO _A	7	DIO, DO	Data bit 8 input/output	Data output for channel A When SEL _C = 0, data from channel C0 are also available on this output When SEL _C = 0 and SEL _B = 0, SDO _A acts as the single data output for all channels
BGND	8	P	Buffer IO ground, connect to digital ground plane	
BVDD	9	P	Buffer IO supply, connect to digital supply (2.7 V to 5.5 V). Decouple with a 1-μF ceramic capacitor or a combination of 100-nF and 10-μF ceramic capacitors to BGND.	
DB7/HB _{EN} /DC _{EN}	10	DIO, DI, DI	Word mode (WORD/BYTE = 0): Data bit 7 input/output Byte mode (WORD/BYTE = 1): High byte enable input. When high, the high byte is output first on DB[15:8]. When low, the low byte is output first on DB[15:8].	Daisy-chain enable input. When high, DB[5:3] serve as daisy-chain inputs DCIN[A:C]. If daisy-chain mode is not used, connect to BGND.
DB6/SCLK	11	DIO, DI	Word mode (WORD/BYTE = 0): Data bit 6 input/output Byte mode (WORD/BYTE = 1): Connect to BGND or BVDD	Serial interface clock input (36 MHz, max)
DB5/DCIN _A	12	DIO, DI	Word mode (WORD/BYTE = 0): Data bit 5 input/output Byte mode (WORD/BYTE = 1): Connect to BGND or BVDD	When DC _{EN} = 1, daisy-chain data input for channel A. When DC _{EN} = 0, connect to BGND.
DB4/DCIN _B	13	DIO, DI	Word mode (WORD/BYTE = 0): Data bit 4 input/output Byte mode (WORD/BYTE = 1): Connect to BGND or BVDD	When SEL _B = 1 and DC _{EN} = 1, daisy-chain data input for channel B. When DC _{EN} = 0, connect to BGND.
DB3/DCIN _C	14	DIO, DI	Word mode (WORD/BYTE = 0): Data bit 3 input/output Byte mode (WORD/BYTE = 1): Connect to BGND or BVDD	When SEL _C = 1 and DC _{EN} = 1, daisy-chain data input for channel C. When DC _{EN} = 0, connect to BGND.

(1) AI = analog input; AIO = analog input/output; DI = digital input; DO = digital output; DIO = digital input/output; and P = power supply.

Pin Functions (continued)

PIN		TYPE ⁽¹⁾	DESCRIPTION	
NAME	NO.		PARALLEL INTERFACE (PAR/SER = 0)	SERIAL INTERFACE (PAR/SER = 1)
DB2/SEL_C	15	DIO, DI	Word mode (WORD/BYTE = 0): Data bit 2 input/output Byte mode (WORD/BYTE = 1): Connect to BGND or BVDD	Select SDO_C input. When high, SDO_C is active. When low, SDO_C is disabled.
DB1/SEL_B	16	DIO, DI	Word mode (WORD/BYTE = 0): Data bit 1 input/output Byte mode (WORD/BYTE = 1): Connect to BGND or BVDD	Select SDO_B input. When high, SDO_B is active. When low, SDO_B is disabled.
DB0/SEL_A	17	DIO, DI	Word mode (WORD/BYTE = 0): Data bit 0 (LSB) input/output Byte mode (WORD/BYTE = 1): Connect to BGND or BVDD	Select SDO_A input. When high, SDO_A is active. When low, SDO_A is disabled. Must always be high.
BUSY/INT	18	DO	When CR bit C21 = 0 (BUSY/INT), converter busy status output. Transitions high when a conversion has been started and remains high during the entire process. Transitions low when the conversion data of all six channels are latched to the output register and remains low thereafter. In sequential mode (SEQ = 1 in the CR), the BUSY output transitions high when a conversion has been started and goes low for a single conversion clock cycle (t _{CCCLK}) whenever a channel pair conversion is completed. When bit C21 = 1 (BUSY/INT in CR), interrupt output. This bit transitions high after a conversion completes and remains high until the conversion result is read. The polarity of BUSY/INT output can be changed using bit C20 (BUSY L/H) in the control register.	
$\overline{\text{CS}}/\overline{\text{FS}}$	19	DI, DI	Chip select input. When low, the parallel interface is enabled. When high, the interface is disabled.	Frame synchronization. The falling edge of $\overline{\text{FS}}$ controls the frame transfer.
$\overline{\text{RD}}$	20	DI	Read data input. When low, the parallel data output is enabled. When high, the data output is disabled.	Connect to BGND.
CONVST_C	21	DI	Hardware mode (HW/SW = 0): Conversion start of channel pair C. The rising edge of this signal initiates simultaneous conversion of analog signals at inputs CH_C[1:0]. CONVST_C must remain high during the entire conversion cycle, otherwise both ADCs of channel C are put in partial power-down mode (see the Reset and Power-Down Modes section). Software mode (HW/SW = 1): Conversion start of channel pair C in sequential mode (CR bit C23 = 1) only; connect to BGND or BVDD otherwise.	
CONVST_B	22	DI	Hardware mode (HW/SW = 0): Conversion start of channel pair B. The rising edge of this signal initiates simultaneous conversion of analog signals at inputs CH_B[1:0]. CONVST_B must remain high during the entire conversion cycle; otherwise, both ADCs of channel B are put into partial power-down mode (see the Reset and Power-Down Modes section). Software mode (HW/SW = 1): Conversion start of channel pair B in sequential mode (CR bit C23 = 1) only; connect to BGND or BVDD otherwise.	
CONVST_A	23	DI	Hardware mode (HW/SW = 0): Conversion start of channel pair A. The rising edge of this signal initiates simultaneous conversion of analog signals at inputs CH_A[1:0]. CONVST_A must remain high during the entire conversion cycle; otherwise, both ADCs of channel A are put into partial power-down mode (see the Reset and Power-Down Modes section). Software mode (HW/SW = 1): Conversion start of all selected channels except in sequential mode (CR bit C23 = 1): Conversion start of channel pair A only.	
$\overline{\text{STBY}}$	24	DI	Standby mode input. When low, the entire device is powered-down (including the internal clock and reference). When high, the device operates in normal mode.	
AGND	25, 32, 37, 38, 43, 44, 49, 52, 53, 55, 57, 59	P	Analog ground, connect to analog ground plane Pin 25 can have a dedicated ground if the difference between its potential and AGND is always kept within ±300 mV.	

Pin Functions (continued)

PIN		TYPE ⁽¹⁾	DESCRIPTION	
NAME	NO.		PARALLEL INTERFACE (PAR/SER = 0)	SERIAL INTERFACE (PAR/SER = 1)
AVDD	26, 34, 35, 40, 41, 46, 47, 50, 60	P	Analog power supply (4.5 V to 5.5 V). Decouple each pin with a 100-nF ceramic capacitor to AGND. Use an additional 10- μ F capacitor to AGND close to the device but without compromising the placement of the smaller capacitor. Pin 26 can have a dedicated power supply if the difference between its potential and AVDD is always kept within ± 300 mV.	
RANGE/XCLK	27	DI, DIO	<p>Hardware mode (HW/SW = 0): Input voltage range select input. When low, the analog input range is $\pm 4 V_{REF}$. When high, the analog input range is $\pm 2 V_{REF}$.</p> <p>Software mode (HW/SW = 1): External conversion clock input, if CR bit C11 (CLKSEL) is set high or internal conversion clock output, if CR bit C10 (CLKOUT_EN) is set high. If not used, connect to BVDD or BGND.</p>	
RESET	28	DI	Reset input, active high. Aborts any ongoing conversions. Resets the internal control register to 0x000003FF. The RESET pulse must be at least 50 ns long.	
WORD/BYTE	29	DI	Output mode selection input. When low, data are transferred in word mode using DB[15:0]. When high, data are transferred in byte mode using DB[15:8] with the byte order controlled by HB _{EN} pin while two accesses are required for a complete 16-bit transfer.	Connect to BGND.
HVSS	30	P	Negative supply voltage for the analog inputs (-16.5 V to -5 V). Decouple with a 100-nF ceramic capacitor to AGND placed next to the device and a 10- μ F capacitor to AGND close to the device but without compromising the placement of the smaller capacitor.	
HVDD	31	P	Positive supply voltage for the analog inputs (5 V to 16.5 V). Decouple with a 100-nF ceramic capacitor to AGND placed next to the device and a 10- μ F capacitor to AGND close to the device but without compromising the placement of the smaller capacitor.	
CH_A0	33	AI	Analog input of channel A0. The input voltage range is controlled by RANGE pin in hardware mode or CR bit C26 (RANGE_A) in software mode.	
CH_A1	36	AI	Analog input of channel A1. The input voltage range is controlled by RANGE pin in hardware mode or CR bit C26 (RANGE_A) in software mode.	
CH_B0	39	AI	Analog input of channel B0. The input voltage range is controlled by RANGE pin in hardware mode or CR bit C27 (RANGE_B) in software mode.	
CH_B1	42	AI	Analog input of channel B1. The input voltage range is controlled by RANGE pin in hardware mode or CR bit C27 (RANGE_B) in software mode.	
CH_C0	45	AI	Analog input of channel C0. The input voltage range is controlled by RANGE pin in hardware mode or CR bit C28 (RANGE_C) in software mode.	
CH_C1	48	AI	Analog input of channel C1. The input voltage range is controlled by RANGE pin in hardware mode or CR bit C28 (RANGE_C) in software mode.	
REFIO	51	AIO	Reference voltage input/output (0.5 V to 3.025 V). The internal reference is enabled via REF _{EN} /WR pin in hardware mode or CR bit C25 (REF _{EN}) in software mode. The output value is controlled by the internal DAC (CR bits C[9:0]). Connect a 470-nF ceramic decoupling capacitor between this pin and pin 52.	
REFC_A	54	AI	Decoupling capacitor for reference of channels A. Connect a 10- μ F ceramic decoupling capacitor between this pin and pin 53.	
REFC_B	56	AI	Decoupling capacitor for reference of channels B. Connect a 10- μ F ceramic decoupling capacitor between this pin and pin 55.	
REFC_C	58	AI	Decoupling capacitor for reference of channels C. Connect a 10- μ F ceramic decoupling capacitor between this pin and pin 57.	
PAR/SER	61	DI	Interface mode selection input. When low, the parallel interface is selected. When high, the serial interface is enabled.	
HW/SW	62	DI	Mode selection input. When low, the hardware mode is selected and part works according to the settings of external pins. When high, the software mode is selected in which the device is configured by writing into the control register.	

Pin Functions (continued)

PIN		TYPE ⁽¹⁾	DESCRIPTION	
NAME	NO.		PARALLEL INTERFACE (PAR/SER = 0)	SERIAL INTERFACE (PAR/SER = 1)
REF _{EN} /WR	63	DI	Hardware mode (HW/SW = 0): Internal reference enable input. When high, the internal reference is enabled (the reference buffers are to be enabled). When low, the internal reference is disabled and an external reference is applied at REFIO.	Hardware mode (HW/SW = 0): Internal reference enable input. When high, the internal reference is enabled (the reference buffers are to be enabled). When low, the internal reference is disabled and an external reference must be applied at REFIO.
			Software mode (HW/SW = 1): Write input. The parallel data input is enabled, when CS and WR are low. The internal reference is enabled by the CR bit C25 (REF _{EN}).	Software mode (HW/SW = 1): Connect to BGND or BVDD. The internal reference is enabled by CR bit C25 (REF _{EN}).
DB15	64	DIO	Data bit 15 (MSB) input/output. Output is '0' for the ADS8557/8.	Connect to BGND.

6 Specifications

6.1 Absolute Maximum Ratings

over operating free-air temperature range (unless otherwise noted)⁽¹⁾

	MIN	MAX	UNIT
Supply voltage, HVDD to AGND	-0.3	18	V
Supply voltage, HVSS to AGND	-18	0.3	V
Supply voltage, AVDD to AGND	-0.3	6	V
Supply voltage, BVDD to BGND	-0.3	6	V
Analog input voltage	HVSS - 0.3	HVDD + 0.3	V
Reference input voltage with respect to AGND	AGND - 0.3	AVDD + 0.3	V
Digital input voltage with respect to BGND	BGND - 0.3	BVDD + 0.3	V
Ground voltage difference AGND to BGND		±0.3	V
Input current to all pins except supply	-10	10	mA
Maximum virtual junction temperature, T _J		150	°C
Storage Temperature, T _{stg}	-65	150	°C

- (1) Stresses beyond those listed under absolute maximum ratings may cause permanent damage to the device. These are stress ratings only and functional operation of the device at these or any other conditions beyond those indicated under recommended operating conditions is not implied. Exposure to absolute-maximum-rated conditions for extended periods may affect device reliability.

6.2 ESD Ratings

		VALUE	UNIT
V _(ESD)	Electrostatic discharge	Human-body model (HBM), per ANSI/ESDA/JEDEC JS-001 JEDEC standard 22, test method A114-C.01 ⁽¹⁾	±2000
		Charged-device model (CDM), per JEDEC specification JESD22-C101 JEDEC standard 22, test method C101 ⁽²⁾	±500

- (1) JEDEC document JEP155 states that 500-V HBM allows safe manufacturing with a standard ESD control process.
(2) JEDEC document JEP157 states that 250-V CDM allows safe manufacturing with a standard ESD control process.

6.3 Recommended Operating Conditions

		MIN	NOM	MAX	UNIT	
Supply voltage, AVDD to AGND		4.5	5	5.5	V	
Supply voltage, BVDD to BGND	Low-voltage levels	2.7	3.0	3.6	V	
	5-V logic levels	4.5	5	5.5		
Input supply voltage, HVDD to AGND	Range 1 ($\pm 2 \times V_{REF}$)	$2 \times V_{REF}$		16.5	V	
	Range 2 ($\pm 4 \times V_{REF}$)	$4 \times V_{REF}$		16.5		
Input supply voltage, HVSS to AGND	Range 1 ($\pm 2 \times V_{REF}$)	-16.5		$-2 \times V_{REF}$	V	
	Range 2 ($\pm 4 \times V_{REF}$)	-16.5		$-4 \times V_{REF}$		
Reference input voltage (V_{REF})		0.5	2.5	3.0	V	
Analog inputs ⁽¹⁾	Range 1 ($\pm 2 \times V_{REF}$)	$-2 \times V_{REF}$		$2 \times V_{REF}$	V	
	Range 1 ($\pm 4 \times V_{REF}$)	$-4 \times V_{REF}$		$4 \times V_{REF}$		
Operating ambient temperature, T_A		-40			125	°C

(1) For more information, see the [Analog Inputs](#) section.

6.4 Thermal Information

THERMAL METRIC ⁽¹⁾			ADS855x	UNIT
			PM (LQFP)	
			64 PINS	
$R_{\theta JA}$	Junction-to-ambient thermal resistance	High-K thermal resistance ⁽²⁾	50.3	°C/W
$R_{\theta JC(top)}$	Junction-to-case (top) thermal resistance		12.0	°C/W
$R_{\theta JB}$	Junction-to-board thermal resistance		24.0	°C/W
Ψ_{JT}	Junction-to-top characterization parameter		0.5	°C/W
Ψ_{JB}	Junction-to-board characterization parameter		23.5	°C/W
$R_{\theta JC(bot)}$	Junction-to-case (bottom) thermal resistance		NA	°C/W

(1) For more information about traditional and new thermal metrics, see the *Semiconductor and IC Package Thermal Metrics* application report, [SPRA953](#).

(2) Modeled in accordance with the Low-K or High-K thermal metric definitions of EIA/JESD51-3.

6.5 Electrical Characteristics: General

over recommended operating free-air temperature range of -40°C to 125°C , AVDD = 4.5 V to 5.5 V, BVDD = 2.7 V to 5.5 V, HVDD = 10 V to 15 V, HVSS = -15 V to -10 V, $V_{REF} = 2.5$ V (internal), and f_{DATA} = maximum (unless otherwise noted)

PARAMETER		TEST CONDITIONS	MIN	TYP ⁽¹⁾	MAX	UNIT
ANALOG INPUT						
CHXX	Bipolar full-scale range	RANGE pin/RANGE bit = 0	$-4 \times V_{REF}$		$4 \times V_{REF}$	V
		RANGE pin/RANGE bit = 1	$-2 \times V_{REF}$		$2 \times V_{REF}$	
	Input capacitance	Input range = $\pm 4 \times V_{REF}$		10		pF
		Input range = $\pm 2 \times V_{REF}$		20		
	Input leakage current	No ongoing conversion			± 1	μA
	Aperture delay			5		ns
	Aperture delay matching	Common CONVST for all channels		250		ps
	Aperture jitter			50		ps
EXTERNAL CLOCK INPUT (XCLK)						
f_{XCLK}	External clock frequency	An external reference must be used for $f_{XCLK} > f_{CCLK}$	1	18	20	MHz
	External clock duty cycle		45%		55%	

(1) All values are at $T_A = 25^{\circ}\text{C}$.

Electrical Characteristics: General (continued)

over recommended operating free-air temperature range of -40°C to 125°C , $\text{AVDD} = 4.5\text{ V}$ to 5.5 V , $\text{BVDD} = 2.7\text{ V}$ to 5.5 V , $\text{HVDD} = 10\text{ V}$ to 15 V , $\text{HVSS} = -15\text{ V}$ to -10 V , $V_{\text{REF}} = 2.5\text{ V}$ (internal), and $f_{\text{DATA}} = \text{maximum}$ (unless otherwise noted)

PARAMETER		TEST CONDITIONS	MIN	TYP ⁽¹⁾	MAX	UNIT
REFERENCE VOLTAGE OUTPUT (REF_{OUT})						
V_{REF}	Reference voltage	2.5-V operation, REFDAC = 0x3FF	2.485	2.5	2.515	V
		2.5-V operation, REFDAC = 0x3FF at 25°C	2.496	2.5	2.504	
		3-V operation, REFDAC = 0x3FF	2.985	3.0	3.015	
		3-V operation, REFDAC = 0x3FF at 25°C	2.995	3.0	3.005	
dV_{REF}/dT	Reference voltage drift		± 10		ppm/°C	
PSRR	Power-supply rejection ratio		73		dB	
I_{REFOUT}	Output current	With dc current	-2		2	mA
I_{REFSC}	Short-circuit current ⁽²⁾			50		mA
t_{REFON}	Turn-on settling time			10		ms
	External load capacitance	At CREF_x pins	4.7	10		μF
		At REFIO pins	100	470		
REFDAC	Tuning range	Internal reference output voltage range	$0.2 \times V_{\text{REF}}$		V_{REF}	V
	REFDAC resolution		10			Bits
DNL_{DAC}	REFDAC differential nonlinearity		-1	± 0.1	1	LSB
INL_{DAC}	REFDAC integral nonlinearity		-2	± 0.1	2	LSB
V_{OSDAC}	REFDAC offset error	$V_{\text{REF}} = 0.5\text{ V}$ (DAC = 0x0CC)	-4	± 0.65	4	LSB
REFERENCE VOLTAGE INPUT (REF_{IN})						
V_{REFIN}	Reference input voltage		0.5	2.5	3.025	V
	Input resistance			100		M Ω
	Input capacitance			5		pF
	Reference input current				1	μA
SERIAL CLOCK INPUT (SCLK)						
f_{SCLK}	Serial clock input frequency		0.1		36	MHz
t_{SCLK}	Serial clock period		0.0278		10	μs
	Serial clock duty cycle		40%		60%	
DIGITAL INPUTS⁽³⁾						
	Logic family		CMOS with Schmitt-Trigger			
	High-level input voltage		$0.7 \times \text{BVDD}$		$\text{BVDD} + 0.3$	V
	Low-level input voltage		$\text{BGND} - 0.3$		$0.3 \times \text{BVDD}$	V
	Input current	$V_I = \text{BVDD}$ to BGND	-50		50	nA
	Input capacitance			5		pF
DIGITAL OUTPUTS⁽³⁾						
	Logic family		CMOS			
	High-level output voltage	$I_{\text{OH}} = 100\ \mu\text{A}$	$\text{BVDD} - 0.6$		BVDD	V
	Low-level output voltage	$I_{\text{OH}} = -100\ \mu\text{A}$	BGND		$\text{BGND} + 0.4$	V
	High-impedance-state output current		-50		50	nA
	Output capacitance			5		pF
	Load capacitance				30	pF

(2) Reference output current is not limited internally.

(3) Specified by design.

Electrical Characteristics: General (continued)

over recommended operating free-air temperature range of -40°C to 125°C , $\text{AVDD} = 4.5\text{ V}$ to 5.5 V , $\text{BVDD} = 2.7\text{ V}$ to 5.5 V , $\text{HVDD} = 10\text{ V}$ to 15 V , $\text{HVSS} = -15\text{ V}$ to -10 V , $V_{\text{REF}} = 2.5\text{ V}$ (internal), and $f_{\text{DATA}} = \text{maximum}$ (unless otherwise noted)

PARAMETER		TEST CONDITIONS	MIN	TYP ⁽¹⁾	MAX	UNIT
POWER-SUPPLY REQUIREMENTS						
AVDD	Analog supply voltage		4.5	5	5.5	V
BVDD	Buffer I/O supply voltage		2.7	3	5.5	V
HVDD	Input positive supply voltage		5	10	16.5	V
HVSS	Input negative supply voltage		-16.5	-10	-5	V
IAVDD	Analog supply current ⁽⁴⁾	$f_{\text{DATA}} = \text{maximum}$		30	36	mA
		ADS8556, $f_{\text{DATA}} = 250\text{ kSPS}$ (auto-NAP mode)		14	16.5	
		ADS8557, $f_{\text{DATA}} = 250\text{ kSPS}$ (auto-NAP mode)		14	17	
		ADS8558, $f_{\text{DATA}} = 250\text{ kSPS}$ (auto-NAP mode)		14	18	
		Auto-NAP mode, no ongoing conversion, internal conversion clock		4	6	
		Power-down mode		0.1	50	μA
IBVDD	Buffer I/O supply current ⁽⁵⁾	$f_{\text{DATA}} = \text{maximum}$		0.9	2	mA
		$f_{\text{DATA}} = 250\text{ kSPS}$ (auto-NAP mode)		0.5	1.5	
		Auto-NAP mode, no ongoing conversion, internal conversion clock		0.1	10	μA
		Power-down mode		0.1	10	
IHVDD	Input positive supply current ⁽⁶⁾	ADS8556, $f_{\text{DATA}} = \text{maximum}$		3	3.5	mA
		ADS8557, $f_{\text{DATA}} = \text{maximum}$		3.1	3.6	
		ADS8558, $f_{\text{DATA}} = \text{maximum}$		3.3	4	
		$f_{\text{DATA}} = 250\text{ kSPS}$ (auto-NAP mode)		1.6	2	μA
		Auto-NAP mode, no ongoing conversion, internal conversion clock		0.2	0.3	
		Power-down mode		0.1	10	
IHVSS	Input negative supply current ⁽⁷⁾	ADS8556, $f_{\text{DATA}} = \text{maximum}$		3.6	4	mA
		ADS8557, $f_{\text{DATA}} = \text{maximum}$		3.6	4.2	
		ADS8558, $f_{\text{DATA}} = \text{maximum}$		4	4.8	
		$f_{\text{DATA}} = 250\text{ kSPS}$ (auto-NAP mode)		1.8	2.2	μA
		Auto-NAP mode, no ongoing conversion, internal conversion clock		0.2	0.25	
		Power-down mode		0.1	10	
Power dissipation ⁽⁸⁾		ADS8556, $f_{\text{DATA}} = \text{maximum}$		251.7	298.5	mW
		ADS8557, $f_{\text{DATA}} = \text{maximum}$		253.2	303	
		ADS8558, $f_{\text{DATA}} = \text{maximum}$		262.2	318	
		ADS8556, $f_{\text{DATA}} = 250\text{ kSPS}$ (auto-NAP mode)		122.5	150	
		ADS8557, $f_{\text{DATA}} = 250\text{ kSPS}$ (auto-NAP mode)		122.5	152.5	
		ADS8558, $f_{\text{DATA}} = 250\text{ kSPS}$ (auto-NAP mode)		122.5	157.5	
		Auto-NAP mode, no ongoing conversion, internal conversion clock		26	38.3	
		Power-down mode		3.8	580	μW

(4) At $\text{AVDD} = 5\text{ V}$.

(5) At $\text{BVDD} = 3\text{ V}$, parallel mode, load capacitance = 6 pF per pin.

(6) At $\text{HVDD} = 15\text{ V}$.

(7) At $\text{HVSS} = -15\text{ V}$.

(8) At $\text{AVDD} = 5\text{ V}$, $\text{BVDD} = 3\text{ V}$, $\text{HVDD} = 15\text{ V}$, and $\text{HVSS} = -15\text{ V}$.

6.6 Electrical Characteristics: ADS8556

over recommended operating free-air temperature range of -40°C to 125°C , $\text{AVDD} = 4.5\text{ V}$ to 5 V , $\text{BVDD} = 2.7\text{ V}$ to 5.5 V , $\text{HVDD} = 10\text{ V}$ to 15 V , $\text{HVSS} = -15\text{ V}$ to -10 V , $V_{\text{REF}} = 2.5\text{ V}$ (internal), and $f_{\text{DATA}} = 630\text{ kSPS}$ in parallel mode or 450 kSPS in serial mode (unless otherwise noted)

PARAMETER		TEST CONDITIONS	MIN	TYP ⁽¹⁾	MAX	UNIT
DC ACCURACY						
	Resolution			16		Bits
	No missing codes		16			Bits
INL	Integral linearity error	At $T_A = -40^{\circ}\text{C}$ to 85°C	-3	± 1.5	3	LSB
		At $T_A = -40^{\circ}\text{C}$ to 125°C	-4	± 1.5	4	
DNL	Differential linearity error	At $T_A = -40^{\circ}\text{C}$ to 85°C	-1	± 0.75	1.5	LSB
		At $T_A = -40^{\circ}\text{C}$ to 125°C	-1	± 0.75	2	
	Offset error		-4	± 0.8	4	mV
	Offset error drift			± 3.5		$\mu\text{V}/^{\circ}\text{C}$
	Gain error	Referenced to voltage at REFIO	-0.75	± 0.25	0.75	%FSR
	Gain error drift	Referenced to voltage at REFIO		± 6		$\text{ppm}/^{\circ}\text{C}$
PSRR	Power-supply rejection ratio	At output code FFFFh, related to AVDD		60		dB
SAMPLING DYNAMICS						
t_{ACQ}	Acquisition time		280			ns
t_{CONV}	Conversion time per ADC				1.26	μs
t_{CCLK}	Internal conversion clock period				18.5	t_{CCLK}
					68.0	ns
f_{DATA}	Throughput rate	Parallel interface, internal clock and reference			630	kSPS
		Serial interface, internal clock and reference			450	
AC ACCURACY						
SNR	Signal-to-noise ratio	At $f_{\text{IN}} = 10\text{ kHz}$, $T_A = -40^{\circ}\text{C}$ to 85°C	90	91.5		dB
		At $f_{\text{IN}} = 10\text{ kHz}$, $T_A = -40^{\circ}\text{C}$ to 125°C	89	91.5		
SINAD	Signal-to-noise ratio + distortion	At $f_{\text{IN}} = 10\text{ kHz}$, $T_A = -40^{\circ}\text{C}$ to 85°C	87	89.5		dB
		At $f_{\text{IN}} = 10\text{ kHz}$, $T_A = -40^{\circ}\text{C}$ to 125°C	86.5	89.5		
THD	Total harmonic distortion ⁽²⁾	At $f_{\text{IN}} = 10\text{ kHz}$, $T_A = -40^{\circ}\text{C}$ to 85°C		-94	-90	dB
		At $f_{\text{IN}} = 10\text{ kHz}$, $T_A = -40^{\circ}\text{C}$ to 125°C		-94	-89.5	
SFDR	Spurious-free dynamic range	At $f_{\text{IN}} = 10\text{ kHz}$, $T_A = -40^{\circ}\text{C}$ to 85°C	90	95		dB
		At $f_{\text{IN}} = 10\text{ kHz}$, $T_A = -40^{\circ}\text{C}$ to 125°C	89.5	95		
	Channel-to-channel isolation	At $f_{\text{IN}} = 10\text{ kHz}$		100		dB
	-3-dB small-signal bandwidth	In $4 \times V_{\text{REF}}$ mode		48		MHz
		In $2 \times V_{\text{REF}}$ mode		24		

(1) All values are at $T_A = 25^{\circ}\text{C}$.

(2) Calculated on the first nine harmonics of the input frequency.

6.7 Electrical Characteristics: ADS8557

over recommended operating free-air temperature range of -40°C to 125°C , $\text{AVDD} = 4.5\text{ V}$ to 5.5 V , $\text{BVDD} = 2.7\text{ V}$ to 5.5 V , $\text{HVDD} = 10\text{ V}$ to 15 V , $\text{HVSS} = -15\text{ V}$ to -10 V , $V_{\text{REF}} = 2.5\text{ V}$ (internal), and $f_{\text{DATA}} = 670\text{ kSPS}$ in parallel mode or 470 kSPS in serial mode (unless otherwise noted)

PARAMETER		TEST CONDITIONS	MIN	TYP ⁽¹⁾	MAX	UNIT
DC ACCURACY						
	Resolution			14		Bits
	No missing codes		14			Bits
INL	Integral linearity error		-1	± 0.4	1	LSB
DNL	Differential linearity error		-1	± 0.25	1	LSB
	Offset error		-4	± 0.8	4	mV
	Offset error drift			± 3.5		$\mu\text{V}/^{\circ}\text{C}$
	Gain error	Referenced to voltage at REFIO	-0.75	± 0.25	0.75	%FSR
	Gain error drift	Referenced to voltage at REFIO		± 6		ppm/ $^{\circ}\text{C}$
PSRR	Power-supply rejection ratio	At output code FFFFh, related to AVDD		60		dB
SAMPLING DYNAMICS						
t_{ACQ}	Acquisition time		280			ns
t_{CONV}	Conversion time per ADC				1.19	μs
t_{CCLK}	Internal conversion clock period				18.5	t_{CCLK}
					64.1	ns
f_{DATA}	Throughput rate	Parallel interface, internal clock and reference			670	kSPS
		Serial interface, internal clock and reference			470	
AC ACCURACY						
SNR	Signal-to-noise ratio	At $f_{\text{IN}} = 10\text{ kHz}$	84	85		dB
SINAD	Signal-to-noise ratio + distortion	At $f_{\text{IN}} = 10\text{ kHz}$	83	84		dB
THD	Total harmonic distortion ⁽²⁾	At $f_{\text{IN}} = 10\text{ kHz}$		-91	-86	dB
SFDR	Spurious-free dynamic range	At $f_{\text{IN}} = 10\text{ kHz}$	86	92		dB
	Channel-to-channel isolation	At $f_{\text{IN}} = 10\text{ kHz}$		100		dB
	-3-dB small-signal bandwidth	In $4 \times V_{\text{REF}}$ mode		48		MHz
		In $2 \times V_{\text{REF}}$ mode		24		

(1) All values are at $T_A = 25^{\circ}\text{C}$.

(2) Calculated on the first nine harmonics of the input frequency.

6.8 Electrical Characteristics: ADS8558

over recommended operating free-air temperature range of -40°C to 125°C , $\text{AVDD} = 4.5\text{ V}$ to 5 V , $\text{BVDD} = 2.7\text{ V}$ to 5.5 V , $\text{HVDD} = 10\text{ V}$ to 15 V , $\text{HVSS} = -15\text{ V}$ to -10 V , $V_{\text{REF}} = 2.5\text{ V}$ (internal), and $f_{\text{DATA}} = 730\text{ kSPS}$ in parallel mode or 500 kSPS in serial mode (unless otherwise noted)

PARAMETER	TEST CONDITIONS	MIN	TYP ⁽¹⁾	MAX	UNIT	
DC ACCURACY						
Resolution			12		Bits	
No missing codes		12			Bits	
INL	Integral linearity error	-0.75	± 0.2	0.75	LSB	
DNL	Differential linearity error	-0.5	± 0.2	0.5	LSB	
	Offset error	-4	± 0.8	4	mV	
	Offset error drift		± 3.5		$\mu\text{V}/^{\circ}\text{C}$	
	Gain error	Referenced to voltage at REFIO	-0.75	± 0.25	0.75	%FSR
	Gain error drift	Referenced to voltage at REFIO		± 6		ppm/ $^{\circ}\text{C}$
PSRR	Power-supply rejection ratio	At output code FFFFh, related to AVDD		60		dB
SAMPLING DYNAMICS						
t_{ACQ}	Acquisition time		280		ns	
t_{CONV}	Conversion time per ADC			1.09	μs	
t_{CCLK}	Internal conversion clock period			18.5	t_{CCLK}	
				58.8	ns	
f_{DATA}	Throughput rate	Parallel interface, internal clock and reference		730	kSPS	
		Serial interface, internal clock and reference		500		
AC ACCURACY						
SNR	Signal-to-noise ratio	At $f_{\text{IN}} = 10\text{ kHz}$	73	73.9	dB	
SINAD	Signal-to-noise ratio + distortion	At $f_{\text{IN}} = 10\text{ kHz}$	73	73.8	dB	
THD	Total harmonic distortion ⁽²⁾	At $f_{\text{IN}} = 10\text{ kHz}$		-89	-84	dB
SFDR	Spurious-free dynamic range	At $f_{\text{IN}} = 10\text{ kHz}$	84	92	dB	
	Channel-to-channel isolation	At $f_{\text{IN}} = 10\text{ kHz}$		100	dB	
	-3-dB small-signal bandwidth	In $4 \times V_{\text{REF}}$ mode		48	MHz	
		In $2 \times V_{\text{REF}}$ mode		24		

(1) All values are at $T_A = 25^{\circ}\text{C}$.

(2) Calculated on the first nine harmonics of the input frequency.

6.9 Power Dissipation Characteristics

over operating free-air temperature range (unless otherwise noted)

PARAMETER	TEST CONDITIONS	MIN	TYP	MAX	UNIT	
P_D	Device power dissipation	ADS8556, $\text{HVDD} = 15\text{ V}$, $\text{HVSS} = -15\text{ V}$, $\text{AVDD} = 5\text{ V}$, $\text{BVDD} = 3\text{ V}$, and $f_{\text{DATA}} = \text{maximum}$		251.7	298.5	mW
		ADS8557, $\text{HVDD} = 15\text{ V}$, $\text{HVSS} = -15\text{ V}$, $\text{AVDD} = 5\text{ V}$, $\text{BVDD} = 3\text{ V}$, and $f_{\text{DATA}} = \text{maximum}$		253.2	303.0	
		ADS8558, $\text{HVDD} = 15\text{ V}$, $\text{HVSS} = -15\text{ V}$, $\text{AVDD} = 5\text{ V}$, $\text{BVDD} = 3\text{ V}$, and $f_{\text{DATA}} = \text{maximum}$		262.2	318.0	

6.10 Serial Interface Timing Requirements

over recommended operating free-air temperature range at -40°C to 125°C , $\text{AVDD} = 5\text{ V}$, and $\text{BVDD} = 2.7\text{ V}$ to 5.5 V (unless otherwise noted)⁽¹⁾

		MIN	NOM	MAX	UNIT
t_{ACQ}	Acquisition time	280			ns
t_{CONV}	Conversion time	ADS8556		1.26	μs
		ADS8557		1.19	
		ADS8558		1.09	
t_1	CONVST_x low time	20			ns
t_2	BUSY low to $\overline{\text{FS}}$ low time	0			ns
t_3	Bus access finished to next conversion start time	ADS8556	40		ns
		ADS8557	20		
		ADS8558	0		
t_{D1}	CONVST_x high to BUSY high delay	5		20	ns
t_{D2}	$\overline{\text{FS}}$ low to SDO_x active delay	5		12	ns
t_{D3}	SCLK rising edge to new data valid delay			15	ns
t_{D4}	$\overline{\text{FS}}$ high to SDO_x 3-state delay			10	ns
t_{H1}	Input data to SCLK falling edge hold time	5			ns
t_{H2}	Output data to SCLK rising edge hold time	5			ns
t_{S1}	Input data to SCLK falling edge setup time	3			ns
t_{S3}	CONVST_x high to XCLK falling or rising edge setup time	6			ns
t_{SCLK}	Serial clock period	0.0278		10	μs

(1) All input signals are specified with $t_{\text{R}} = t_{\text{F}} = 1.5\text{ ns}$ (10% to 90% of BVDD) and timed from a voltage level of $(V_{\text{IL}} + V_{\text{IH}}) / 2$.

6.11 Parallel Interface Timing Requirements (Read Access)

over recommended operating free-air temperature range at -40°C to 125°C , $\text{AVDD} = 5\text{ V}$, and $\text{BVDD} = 2.7\text{ V}$ to 5.5 V (unless otherwise noted)⁽¹⁾

		MIN	NOM	MAX	UNIT
t_{ACQ}	Acquisition time	280			ns
t_{CONV}	Conversion time	ADS8556		1.26	μs
		ADS8557		1.19	
		ADS8558		1.09	
t_1	CONVST_x low time	20			ns
t_2	BUSY low to $\overline{\text{CS}}$ low time	0			ns
t_3	Bus access finished to next conversion start time ⁽²⁾	ADS8556	40		ns
		ADS8557	20		
		ADS8558	0		
t_4	$\overline{\text{CS}}$ low to $\overline{\text{RD}}$ low time	0			ns
t_5	$\overline{\text{RD}}$ high to $\overline{\text{CS}}$ high time	0			ns
t_6	$\overline{\text{RD}}$ pulse duration	30			ns
t_7	Minimum time between two read accesses	10			ns
t_{D1}	CONVST_x high to BUSY high delay	5		20	ns
t_{D5}	$\overline{\text{RD}}$ falling edge to output data valid delay			20	ns
t_{H3}	Output data to $\overline{\text{RD}}$ rising edge hold time	5			ns

(1) All input signals are specified with $t_{\text{R}} = t_{\text{F}} = 1.5\text{ ns}$ (10% to 90% of BVDD) and timed from a voltage level of $(V_{\text{IL}} + V_{\text{IH}}) / 2$.

(2) Refer to the $\overline{\text{CS}}$ signal or $\overline{\text{RD}}$, whichever occurs first.

6.12 Parallel Interface Timing Requirements (Write Access)

over recommended operating free-air temperature range at -40°C to 125°C , $\text{AVDD} = 5\text{ V}$, and $\text{BVDD} = 2.7\text{ V}$ to 5.5 V (unless otherwise noted)⁽¹⁾

		MIN	NOM	MAX	UNIT
t_8	$\overline{\text{CS}}$ low to WR low time	0			ns
t_9	WR low pulse duration	15			ns
t_{10}	WR high pulse duration	10			ns
t_{11}	WR high to $\overline{\text{CS}}$ high time	0			ns
t_{S2}	Output data to WR rising edge setup time	5			ns
t_{H4}	Data output to WR rising edge hold time	5			ns

(1) All input signals are specified with $t_R = t_F = 1.5\text{ ns}$ (10% to 90% of BVDD) and timed from a voltage level of $(V_{IL} + V_{IH}) / 2$.

Input range: $\pm 2V_{REF}$

Input range: $\pm 4V_{REF}$

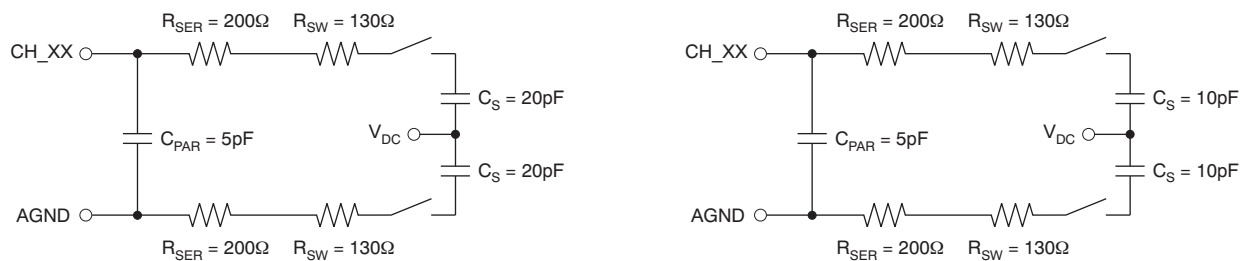

Figure 1. Equivalent Input Circuits

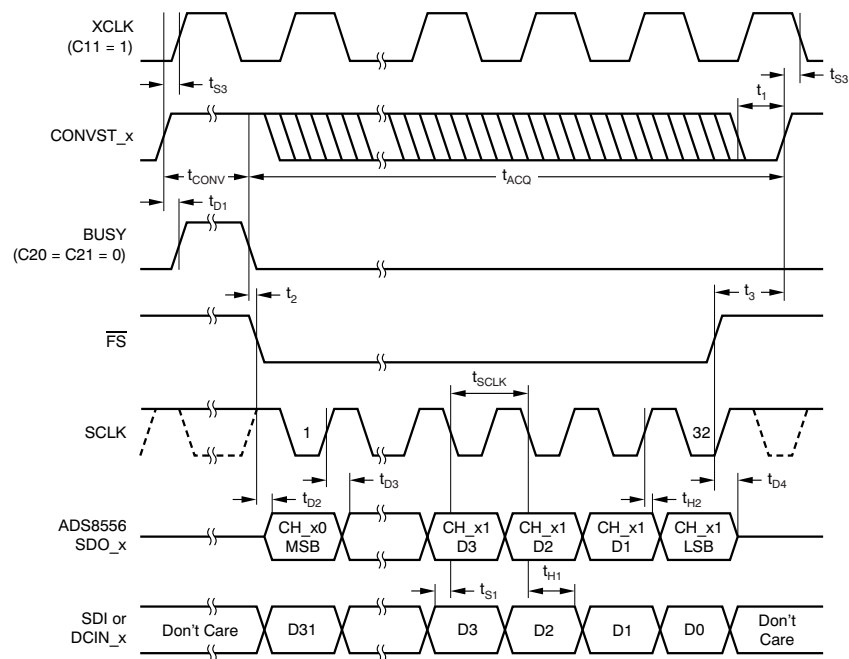

Figure 2. Serial Operation Timing Diagram (All Three SDOs Active)

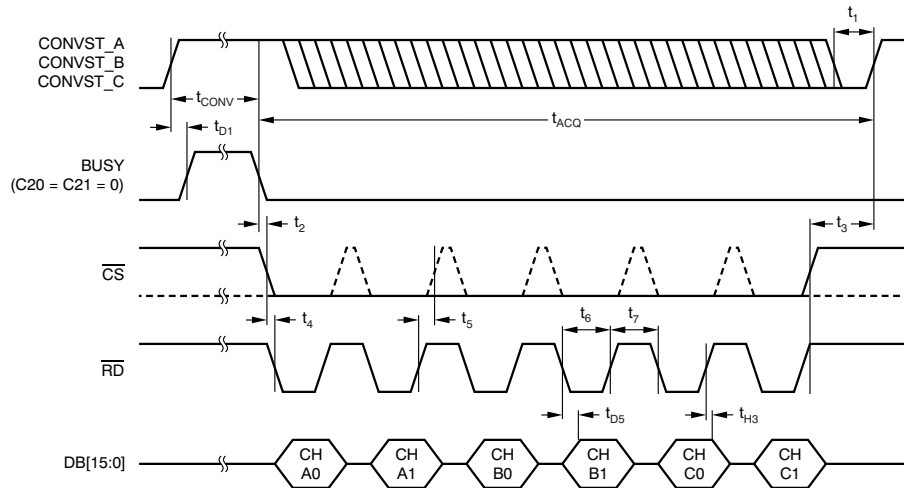

Figure 3. Parallel Read Access Timing Diagram

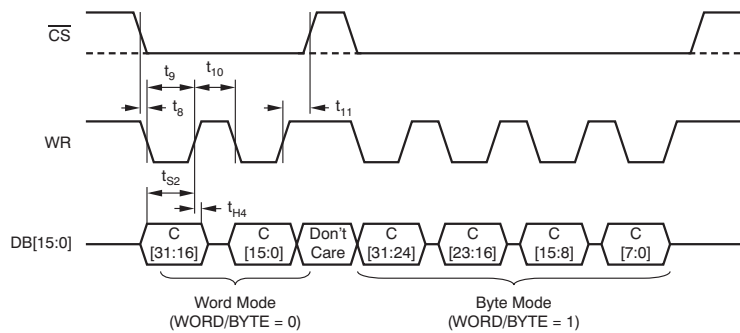
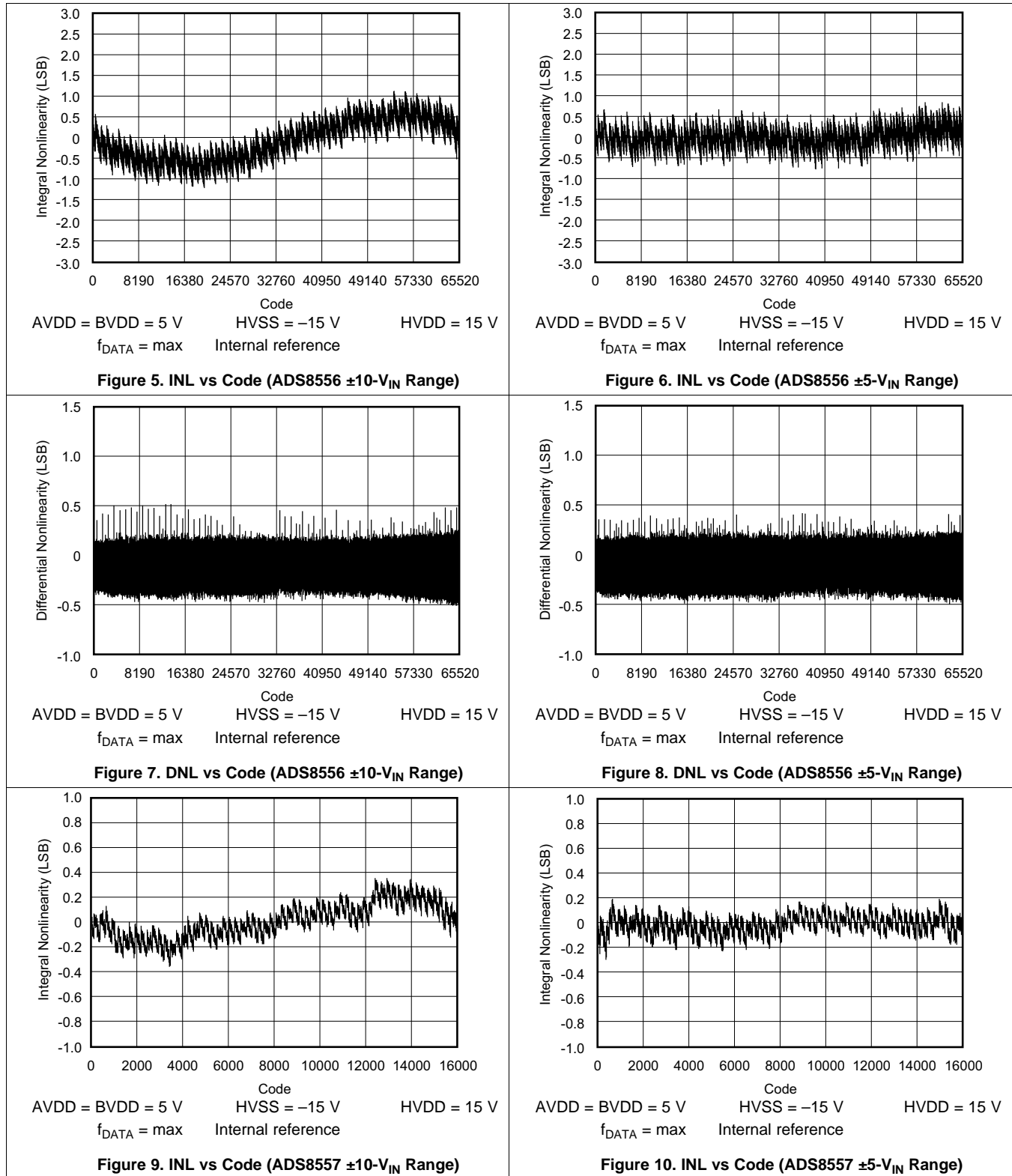

Figure 4. Parallel Write Access Timing Diagram

6.13 Typical Characteristics

at 25°C, over entire supply voltage range, $V_{REF} = 2.5\text{ V}$ (internal), and $f_{DATA} = \text{maximum}$ (unless otherwise noted)



Typical Characteristics (continued)

at 25°C, over entire supply voltage range, $V_{REF} = 2.5\text{ V}$ (internal), and $f_{DATA} = \text{maximum}$ (unless otherwise noted)

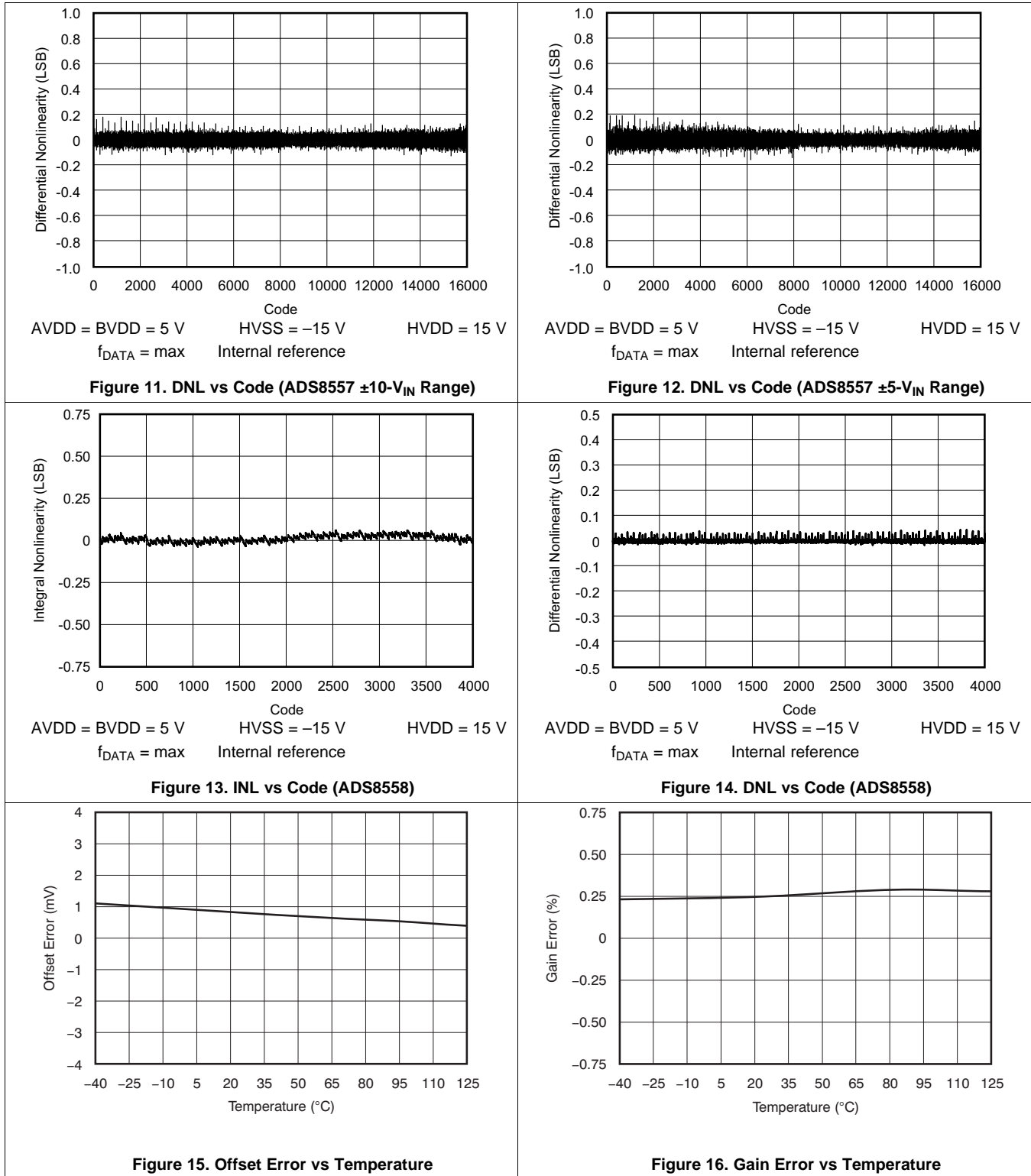

Typical Characteristics (continued)

at 25°C, over entire supply voltage range, $V_{REF} = 2.5\text{ V}$ (internal), and $f_{DATA} = \text{maximum}$ (unless otherwise noted)

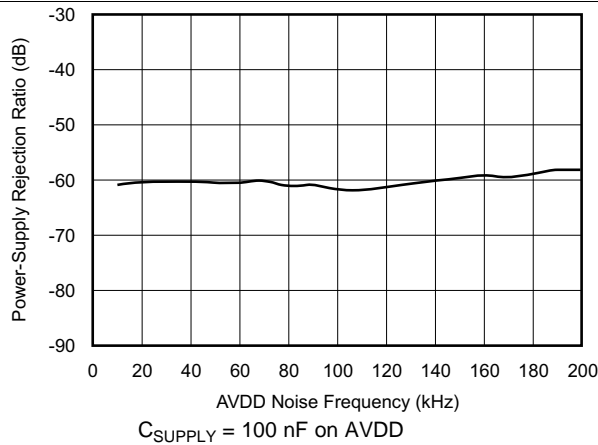

Figure 17. PSRR vs AVDD Noise Frequency

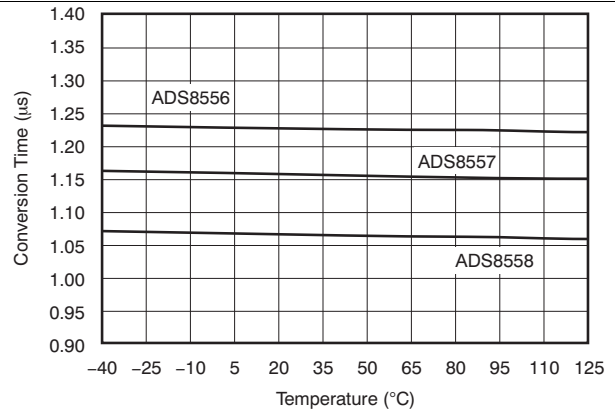

Figure 18. Conversion Time vs Temperature

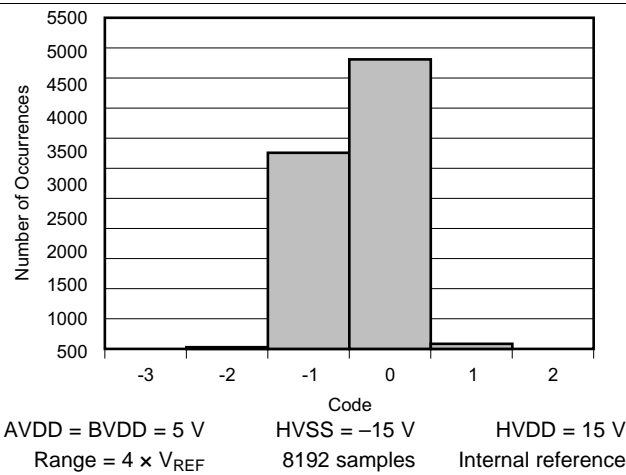

Figure 19. Code Histogram (8192 Hits)

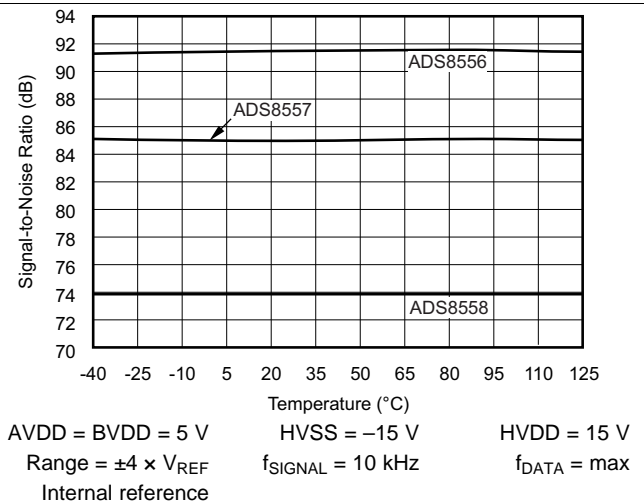

Figure 20. SNR vs Temperature

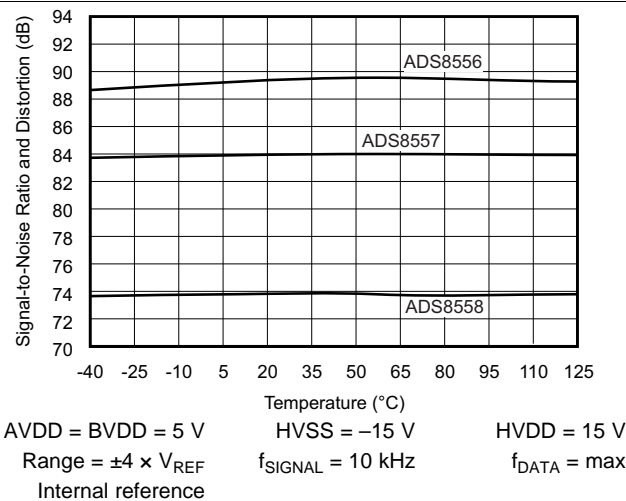

Figure 21. SINAD vs Temperature

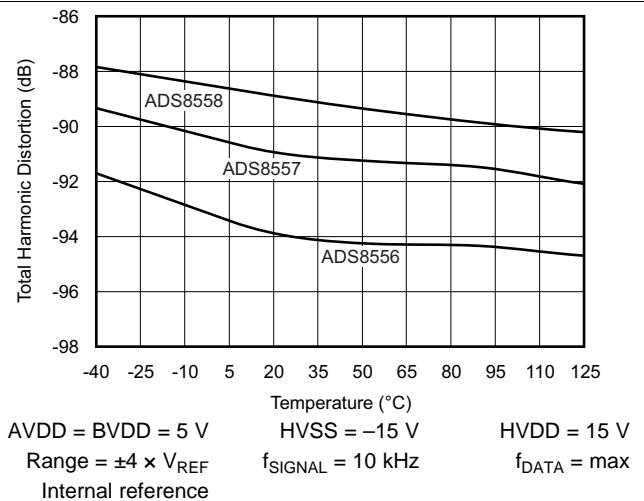
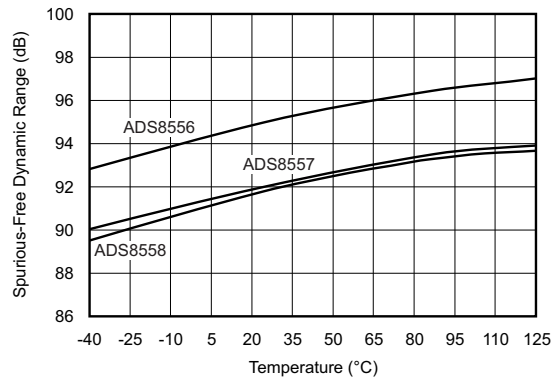

Figure 22. THD vs Temperature

Typical Characteristics (continued)

at 25°C, over entire supply voltage range, $V_{REF} = 2.5\text{ V}$ (internal), and $f_{DATA} = \text{maximum}$ (unless otherwise noted)



AVDD = BVDD = 5 V HVSS = -15 V HVDD = 15 V
 Range = $\pm 4 \times V_{REF}$ $f_{SIGNAL} = 10\text{ kHz}$ $f_{DATA} = \text{max}$
 Internal reference

Figure 23. SFDR vs Temperature

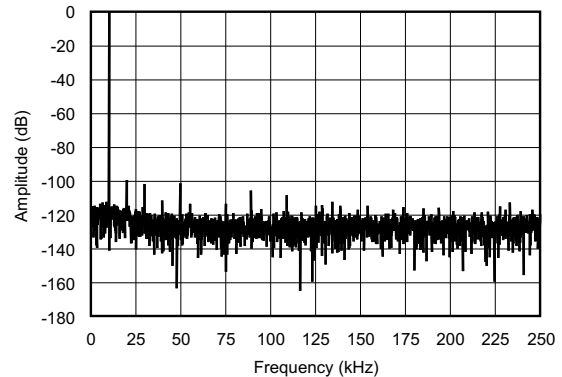

AVDD = BVDD = 5 V $f_{SAMPLE} = 500\text{ kSPS}$ HVSS = -15 V
 Range = $\pm 4 \times V_{REF}$ $f_{SIGNAL} = 10\text{ kHz}$ HVDD = 15 V
 Internal reference

Figure 24. Frequency Spectrum (2048-Point FFT, $f_{IN} = 10\text{ kHz}$, $\pm 10\text{-}V_{IN}$ Range)

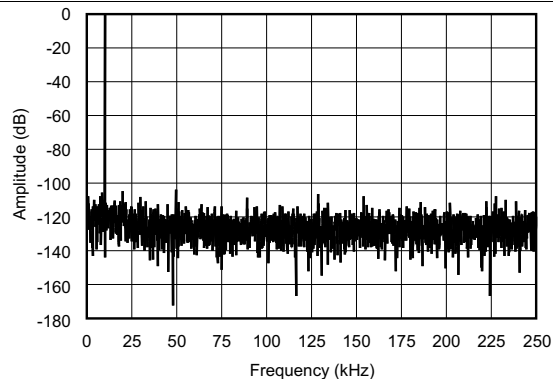

AVDD = BVDD = 5 V $f_{SAMPLE} = 500\text{ kSPS}$ HVSS = -15 V
 Range = $\pm 2 \times V_{REF}$ $f_{SIGNAL} = 10\text{ kHz}$ HVDD = 15 V
 Internal reference

Figure 25. Frequency Spectrum (2048-Point FFT, $f_{IN} = 10\text{ kHz}$, $\pm 5\text{-}V_{IN}$ Range)

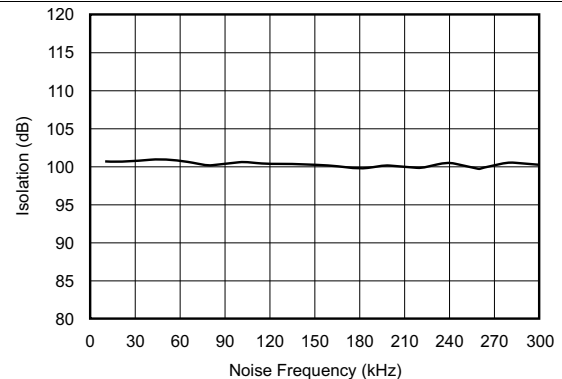

AVDD = BVDD = 5 V HVSS = -15 V HVDD = 15 V
 Range = $\pm 2 \times V_{REF}$ $f_{DATA} = \text{max}$ Internal reference

Figure 26. Channel-to-Channel Isolation vs Input Noise Frequency

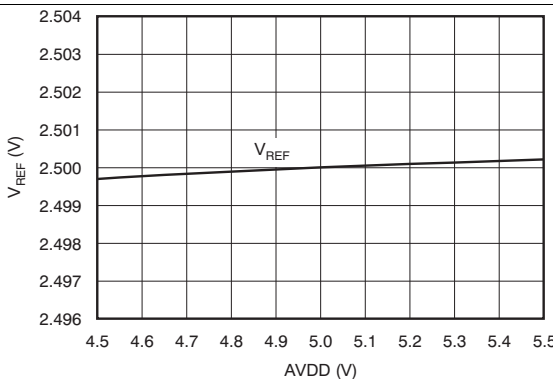

Figure 27. Internal Reference Voltage vs Analog Supply Voltage (2.5-V Mode)

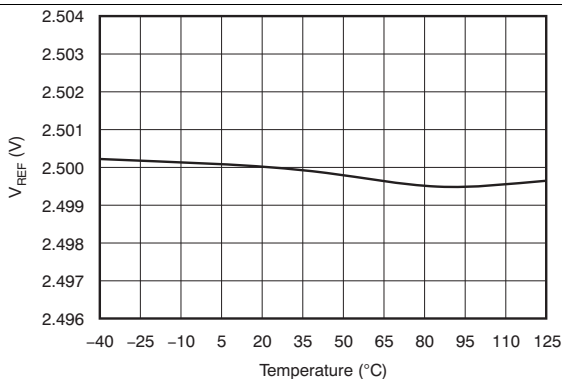

Figure 28. Internal Reference Voltage vs Temperature (2.5-V Mode)

Typical Characteristics (continued)

at 25°C, over entire supply voltage range, $V_{REF} = 2.5\text{ V}$ (internal), and $f_{DATA} = \text{maximum}$ (unless otherwise noted)

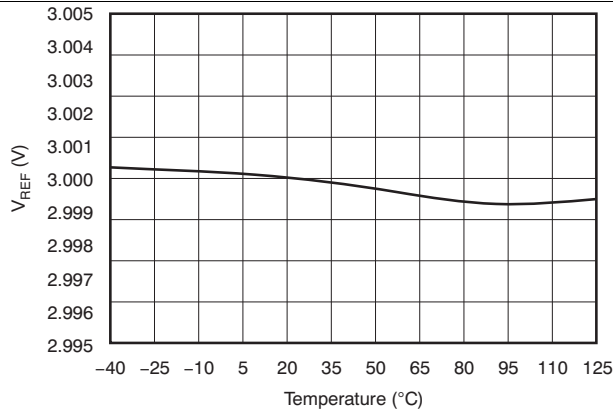
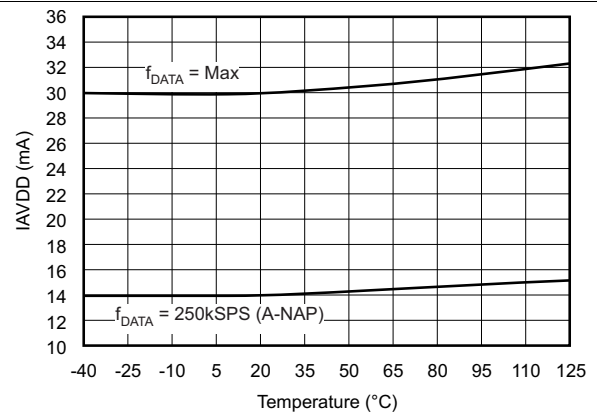
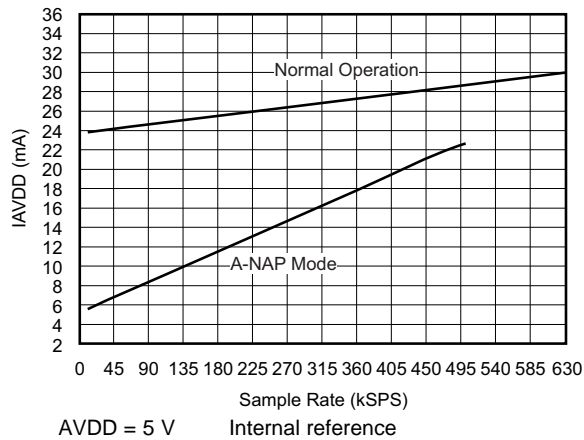

Figure 29. Internal Reference Voltage vs Temperature (3-V Mode)



AVDD = 5 V Internal reference

Figure 30. Analog Supply Current vs Temperature



AVDD = 5 V Internal reference

Figure 31. ADS8556 Analog Supply Current vs Data Rate

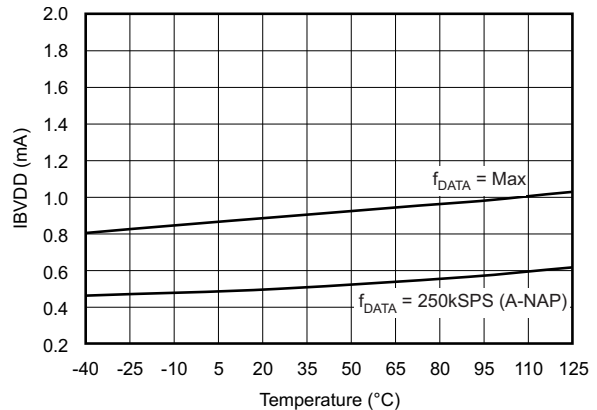

BVDD = 5 V

Figure 32. Buffer I/O Supply Current vs Temperature

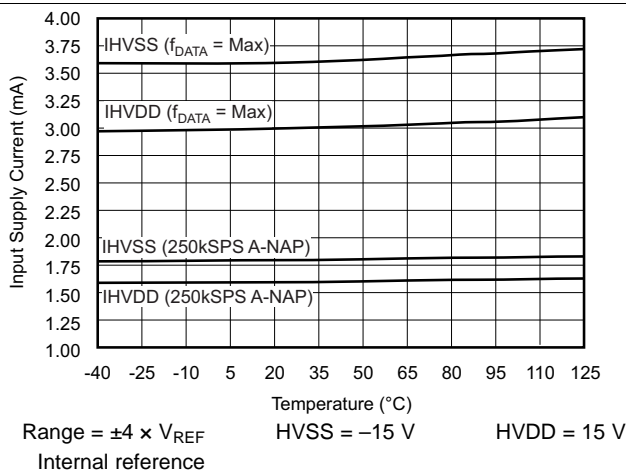

Range = $\pm 4 \times V_{REF}$ HVSS = -15 V HVDD = 15 V
Internal reference

Figure 33. ADS8556 Input Supply Current vs Temperature

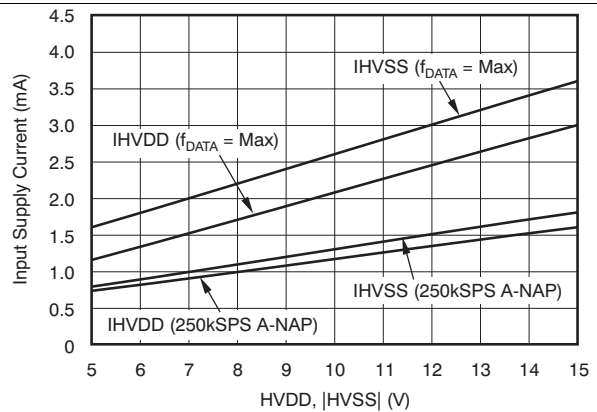
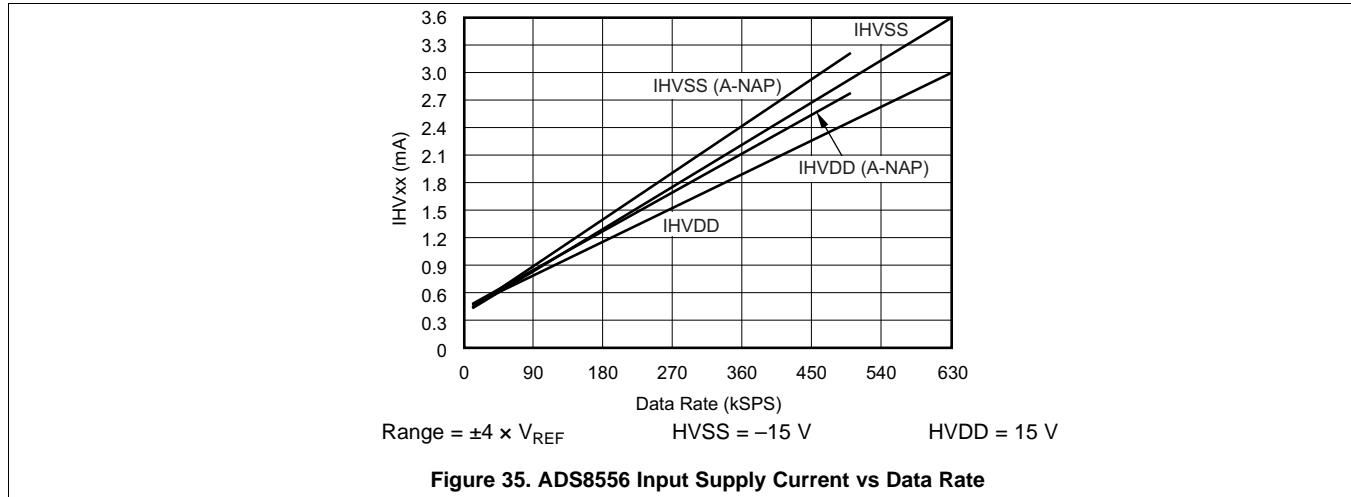

Figure 34. ADS8556 Input Supply Current vs Input Supply Voltage

Typical Characteristics (continued)

 at 25°C, over entire supply voltage range, $V_{REF} = 2.5\text{ V}$ (internal), and $f_{DATA} = \text{maximum}$ (unless otherwise noted)

7 Detailed Description

7.1 Overview

The ADS855x series includes six 16-, 14-, and 12-bit analog-to-digital converters (ADCs) respectively that operate based on the successive approximation register (SAR) principle. The architecture is designed on the charge redistribution principle that inherently includes a sample-and-hold function. The six analog inputs are grouped into three channel pairs. These channel pairs can be sampled and converted simultaneously, preserving the relative phase information of the signals of each pair. Separate conversion start signals allow simultaneous sampling on each channel pair: on four channels or on all six channels.

These devices accept single-ended, bipolar analog input signals in the selectable ranges of $\pm 4 V_{REF}$ or $\pm 2 V_{REF}$ with an absolute value of up to $\pm 12 V$; see the [Analog Inputs](#) section.

The devices offer an internal 2.5-V or 3-V reference source followed by a 10-bit, digital-to-analog converter (DAC) that allows the reference voltage V_{REF} to be adjusted in 2.44-mV or 2.93-mV steps, respectively.

The ADS855x also offers a selectable parallel or serial interface that can be used in hardware or software mode; see the [Device Configuration](#) section for details.

7.2 Functional Block Diagram

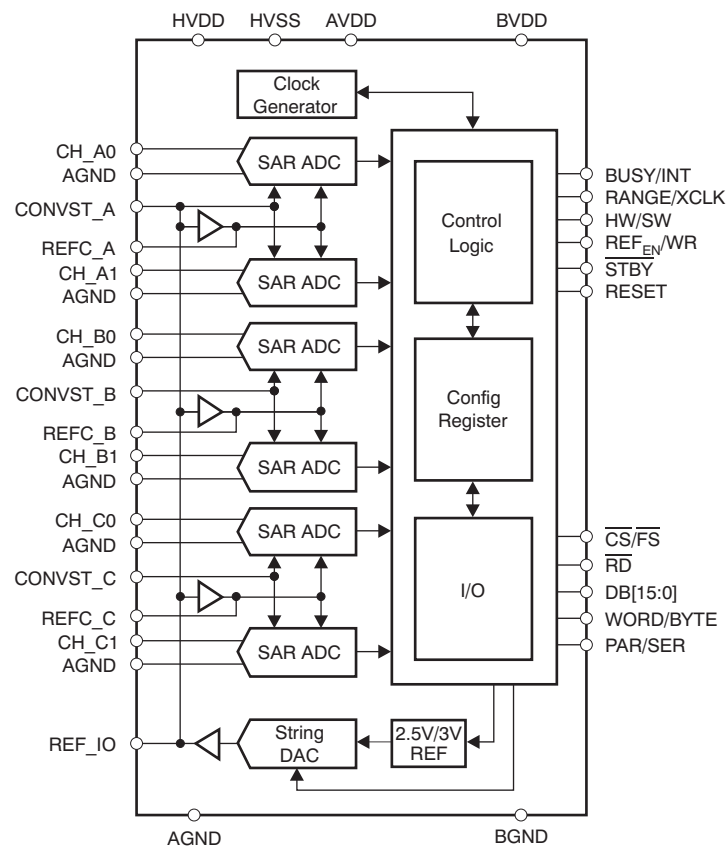

7.3 Feature Description

7.3.1 Analog

This section addresses the analog input circuit, the ADCs and control signals, and the reference design of the device.

7.3.1.1 Analog Inputs

The inputs and the converters are of single-ended, bipolar type. The absolute voltage range can be selected using the RANGE pin (in hardware mode) or RANGE_x bits (in software mode) in the control register (CR) to either $\pm 4 V_{REF}$ or $\pm 2 V_{REF}$. With the reference set to 2.5 V (CR bit C18 = 0), the input voltage range can be ± 10 V or ± 5 V. With the reference source set to 3 V (CR bit C18 = 1), an input voltage range of ± 12 V or ± 6 V can be configured. The logic state of the RANGE pin is latched with the falling edge of BUSY (if CR bit C20 = 0).

The input current on the analog inputs depends on the actual sample rate, input voltage, and signal source impedance. Essentially, the current into the analog inputs charges the internal capacitor array only during the sampling period (t_{ACQ}). The source of the analog input voltage must be able to charge the input capacitance of 10 pF in $\pm 4 V_{REF}$ mode or 20 pF in $\pm 2 V_{REF}$ to a 12-, 14-, 16-bit accuracy level within the acquisition time of 280 ns at maximum data rate; see [Figure 1](#). During the conversion period, there is no further input current flow and the input impedance is greater than 1 M Ω . To ensure a defined start condition, the sampling capacitors of the ADS855x are pre-charged to a fixed internal voltage before switching into sampling mode.

To maintain the linearity of the converter, the inputs must always remain within the specified range of HVSS – 0.2 V to HVDD + 0.2 V.

The minimum –3-dB bandwidth of the driving operational amplifier can be calculated using [Equation 1](#):

$$f_{-3dB} = \frac{\ln(2) \times (n + 1)}{2\pi \times t_{ACQ}}$$

where

- $n = 16, 14, \text{ or } 12$; n is the resolution of the ADS855x (1)

With a minimum acquisition time of $t_{ACQ} = 280$ ns, the required minimum bandwidth of the driving amplifier is 6.7 MHz for the ADS8556, 6 MHz for the ADS8557, or 5.2 MHz for the ADS8558. The required bandwidth can be lower if the application allows a longer acquisition time. A gain error occurs if a given application does not fulfill the bandwidth requirement shown in [Equation 1](#).

A driving operational amplifier may not be required if the impedance of the signal source (R_{SOURCE}) fulfills the requirement of [Equation 2](#):

$$R_{SOURCE} < \frac{t_{ACQ}}{C_s \ln(2) \times (n + 1)} - (R_{SER} + R_{SW})$$

where

- $n = 16, 14, \text{ or } 12$; n is the resolution of the ADC
- $C_s = 10$ pF is the sample capacitor value for $V_{IN} = \pm 4 \times V_{REF}$ mode
- $R_{SER} = 200$ Ω is the input resistor value
- $R_{SW} = 130$ Ω is the switch resistance value (2)

With $t_{ACQ} = 280$ ns, the maximum source impedance must be less than 2.0 k Ω for the ADS8556, 2.3 k Ω for the ADS8557, and 2.7 k Ω for the ADS8558 in $V_{IN} = \pm 4 V_{REF}$ mode or less than 0.8 k Ω for the ADS8556, 1.0 k Ω for the ADS8557, and 1.2 k Ω for the ADS8558 in $V_{IN} = \pm 2 V_{REF}$ mode. The source impedance can be higher if the application allows longer acquisition time.

7.3.1.2 Analog-to-Digital Converter (ADC)

The devices include six ADCs that operate with either an internal or an external conversion clock. The conversion time can be as low as 1.09 μ s with an internal conversion clock (ADS8558). When an external clock and reference are used, the minimum conversion time is 925 ns.

Feature Description (continued)

7.3.1.3 Conversion Clock

The device uses either an internally-generated or an external (XCLK) conversion clock signal (in software mode only). In default mode, the device generates an internal clock. When the CLKSEL bit is set high (bit C11 in the CR), an external conversion clock of up to 20 MHz (max) can be applied on pin 27. In both cases, 18.5 clock cycles are required for a complete conversion including the pre-charging of the sample capacitors. The external clock can remain low between conversions.

The conversion clock duty cycle must be 50%. However, the ADS855x functions properly with a duty cycle between 45% and 55%.

7.3.1.4 CONVST_x

The analog inputs of each channel pair (CH_x0, CH_x1) are held with the rising edge of the corresponding CONVST_x signal. Only in software mode (except for sequential mode) is CONVST_A used for all six ADCs. The conversion automatically starts with the next edge of the conversion clock. CONVST_x must remain high during the entire conversion cycle and the BUSY signal must remain active. A falling edge during an ongoing conversion puts the related ADC pair into partial power-down mode, see the [Reset and Power-Down Modes](#) section for more details.

For simultaneous sampling, connecting all associated CONVST_x pins together is recommended. If the CONVST_x signals are not tied together, a maximum skew of 4 ns must be ensured for all three signals in any order. A CONVST_x signal issued during an ongoing conversion on any channel is blocked, except in sequential mode; see the [Sequential Mode](#) section for more details.

If a parallel interface is used, the behavior of the output port depends on which CONVST_x signals are issued. [Figure 36](#) shows examples of different scenarios.

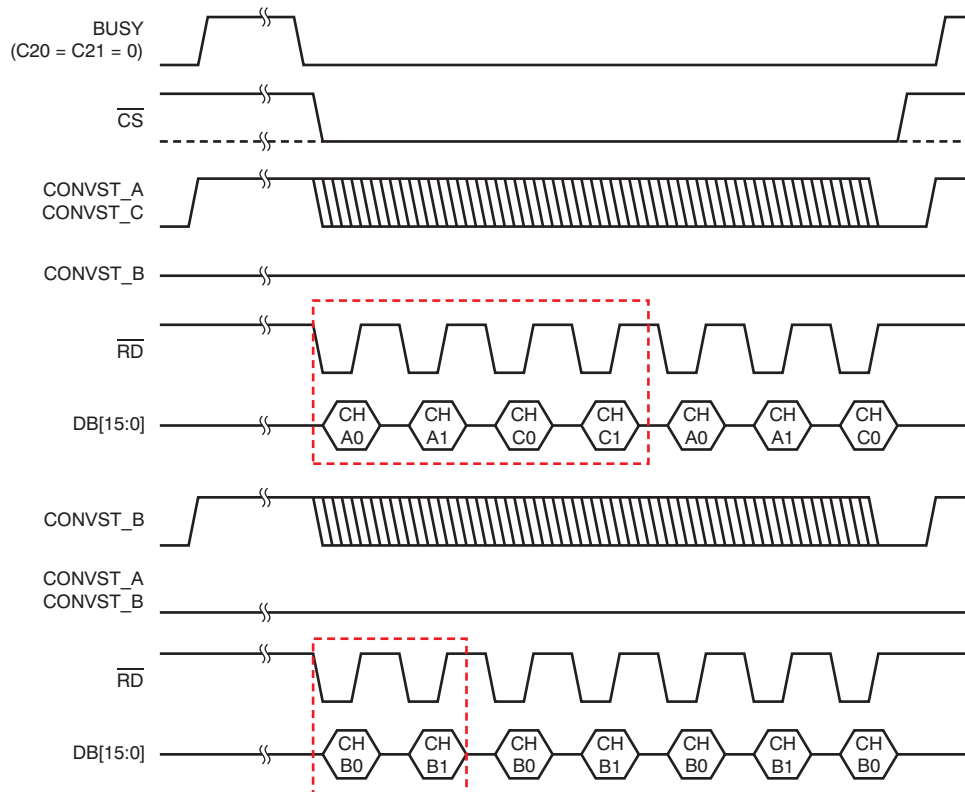

NOTE: Boxed areas indicate the minimum required frame to acquire all data.

Figure 36. Data Output versus CONVST_x

Feature Description (continued)

7.3.1.5 BUSY/INT

The BUSY signal indicates if a conversion is in progress. The BUSY signal goes high with a rising edge of any CONVST_x signal and goes low when the output data of the last channel pair are available in the respective output register. The readout of the data can be initiated immediately after the falling edge of BUSY. A falling edge of a CONVST_x input during an ongoing conversion (when BUSY is high) powers down the corresponding ADC pair.

In sequential mode, the BUSY signal goes low only for one clock cycle; see the [Sequential Mode](#) section for more details.

The polarity of the BUSY/INT signal can be changed using CR bit C20.

7.3.1.6 Reference

The ADS855x provides an internal, low-drift, 2.5-V reference source. To increase the input voltage range, the reference voltage can be switched to 3-V mode using the V_{REF} bit (bit C18 in the CR). The reference feeds a 10-bit string-DAC controlled by bits C[9:0] in the control register. The buffered DAC output is connected to the REFIO pin. In this way, the voltage at this pin is programmable in 2.44-mV (2.92 mV in 3-V mode) steps and adjustable to the application needs without additional external components. The actual output voltage can be calculated using [Equation 3](#):

$$V_{\text{REF}} = \frac{\text{Range} \times (\text{Code} + 1)}{1024}$$

where

- Range = the chosen maximum reference voltage output range (2.5 V or 3 V)
 - Code = the decimal value of the DAC register content
- (3)

[Table 1](#) lists some examples of internal reference DAC settings with a reference range set to 2.5 V. However, to ensure proper performance, the DAC output voltage must not be programmed below 0.5 V.

Decouple the buffered output of the DAC with a 100-nF capacitor (minimum); for best performance, a 470-nF capacitor is recommended. If the internal reference is placed into power-down (default), an external reference voltage can drive the REFIO pin.

The voltage at the REFIO pin is buffered with three internal amplifiers, one for each ADC pair. The output of each buffer must be decoupled with a 10-μF capacitor between pin pairs 53 and 54, 55 and 56, and 57 and 58. The 10-μF capacitors are available as ceramic 0805-SMD components and in X5R quality.

The internal reference buffers can be powered down to decrease the power dissipation of the device. In this case, external reference drivers can be connected to REFC_A, REFC_B, and REFC_C pins. With 10-μF decoupling capacitors, the minimum required bandwidth can be calculated using [Equation 4](#):

$$f_{-3\text{dB}} = \frac{\ln(2)}{2\pi \times t_{\text{CONV}}}$$
(4)

With the minimum t_{CONV} of 1.09 μs, the external reference buffers require a minimum bandwidth of 102 kHz.

Table 1. DAC Setting Examples (2.5-V Operation)

V _{REF OUT} (V)	DECIMAL CODE	BINARY CODE	HEXADECIMAL CODE
0.500	204	00 1100 1100	CC
1.25	511	01 1111 1111	1FF
2.500	1023	11 1111 1111	3FF

7.3.2 Digital

This section describes the digital control and the timing of the device in detail.

7.3.2.1 Device Configuration

Depending on the desired mode of operation, the ADS855x can be configured using the external pins or the control register (CR), as shown in [Table 2](#).

Table 2. ADS855x Configuration Settings

INTERFACE MODE	HARDWARE MODE (HW/SW = 0) CONVERSION START CONTROLLED BY SEPARATE CONVST_x PINS	SOFTWARE MODE (HW/SW = 1) CONVERSION START CONTROLLED BY CONVST_A PIN ONLY, EXCEPT IN SEQUENTIAL MODE
Parallel (PAR/SER = 0)	Configuration using pins, optionally, control bits C[22:18], C[15:13], and C[9:0]	Configuration using control register bits C[31:0] only; status of pins 27 (only if used as RANGE input) and 63 is disregarded
Serial (PAR/SER = 1)	Configuration using pins, optionally, control bits C[22:18], C[15:13], and C[9:0]; bits C[31:24] are disregarded	Configuration using control register bits C[31:0] only; status of pins 1, 27 (only if used as RANGE input), and 63 is disregarded; each access requires a control register update via SDI (see the Serial Interface section for details)

7.3.2.2 Parallel Interface

To use the device with the parallel interface, hold the PAR/SER pin low. The maximum achievable data throughput rate using the internal clock is 630 kSPS for the ADS8556, 670 kSPS for the ADS8557, and 730 kSPS for the ADS8558 in this case.

Access to the ADS855x is controlled as illustrated in [Figure 3](#) and [Figure 4](#).

The device can either operate with a 16-bit (WORD/BYTE pin set low) or an 8-bit (WORD/BYTE pin set high) parallel interface. If 8-bit operation is used, the HB_{EN} pin selects if the low-byte (DB7 low) or the high-byte (DB7 high) is available on the data output DB[15:8] first.

7.3.2.3 Serial Interface

The serial interface mode is selected by setting the PAR/SER pin high. In this case, each data transfer starts with the falling edge of the frame synchronization input (\overline{FS}). The conversion results are presented on the serial data output pins SDO_A, SDO_B, and SDO_C depending on the selections made using the SEL_x pins. Starting with the most significant bit (MSB), the output data are changed at the rising edge of SCLK so that the host processor can read it at the following falling edge. Output data of the ADS8557 and ADS8558 maintain the 16-bit format with leading zeros.

Serial data input SDI are latched at the falling edge of SCLK.

The serial interface can be used with one, two, or three output ports. These ports are enabled with pins SEL_A, SEL_B, and SEL_C. If all three serial data output ports (SDO_A, SDO_B, and SDO_C) are selected, the data can be read with either two 16-bit data transfers or with one 32-bit data transfer. The data of channels CH_x0 are available first, followed by data from channels CH_x1. The maximum achievable data throughput rate is 450 kSPS for the ADS8556, 470 kSPS for the ADS8557, and 500 kSPS for the ADS8558 in this case.

If the application allows a data transfer using two ports only, then the SDO_A and SDO_B outputs are used. The device outputs data from channel CH_A0 followed by CH_A1 and CH_C0 on SDO_A and data from channel CH_B0 followed by CH_B1 and CH_C1 occurs on SDO_B. In this case, a data transfer of three consecutive 16-bit words or one continuous 48-bit word is supported. The maximum achievable data throughput rate is 375 kSPS for the ADS8556, 390 kSPS for the ADS8557, and 400 kSPS for the ADS8558.

The output SDO_A is selected if only one serial data port is used in the application. Data are available in the following order: CH_A0, CH_A1, CH_B0, CH_B1, CH_C0, and, finally CH_C1. Data can be read using six 16-bit transfers, three 32-bit transfers, or a single 96-bit transfer. The maximum achievable data throughput rate is 250 kSPS for the ADS8556, ADS8557 and 260 kSPS for the ADS8558 in this case.

[Figure 2](#) (the serial operation timing diagram) and [Figure 37](#) illustrate all possible scenarios in more detail.

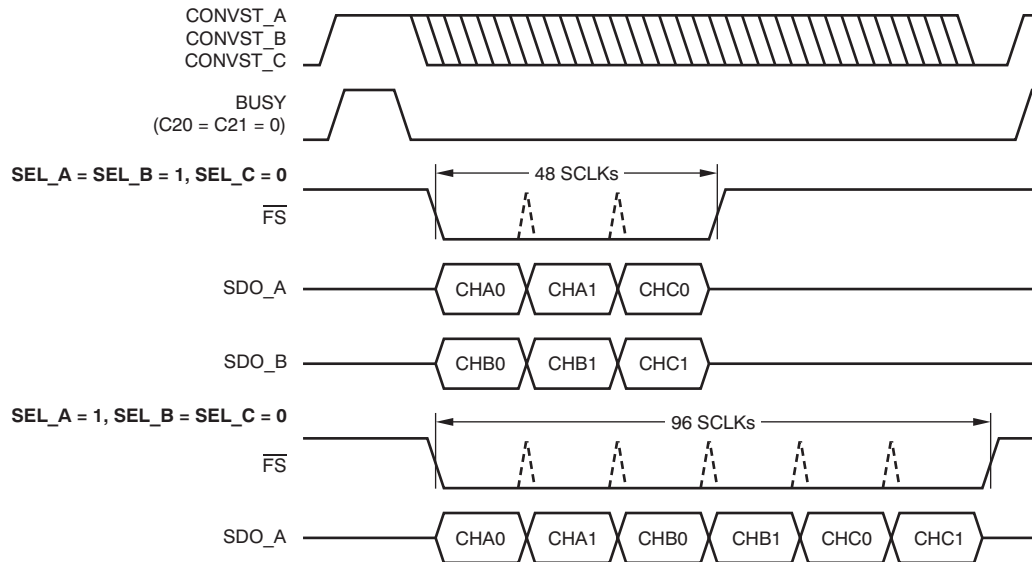
Figure 37. Serial Interface: Data Output with One or Two Active SDOs

7.3.2.4 Output Data Format

The data output format of the ADS855x is binary twos complement, as shown in [Table 3](#).

For the ADS8557, which delivers 14-bit conversion results, the leading two bits of the 16-bit frame are '0' in the serial interface mode. In parallel interface mode, the output pins DB[15:14] are held low.

Respectively, when the ADS8558 outputs 12 bits of data, the first four bits of a serial 16-bit frame are zeros, in parallel interface mode the output pins DB[15:12] are held low.

Table 3. Output Data Format

DESCRIPTION	INPUT VOLTAGE VALUE	BINARY CODE (HEXADECIMAL CODE)		
		ADS8556	ADS8557	ADS8558
Positive full-scale	$4 V_{REF}$ or $2 V_{REF}$	0111 1111 1111 1111 (7FFF)	0001 1111 1111 1111 (1FFF)	0000 0111 1111 1111 (7FF)
Midscale + 0.5LSB	$V_{REF} / (2 \times \text{resolution})$	0000 0000 0000 0000 (0000)	0000 0000 0000 0000 (0000)	0000 0000 0000 0000 (0000)
Midscale – 0.5LSB	$-V_{REF} / (2 \times \text{resolution})$	1111 1111 1111 1111 (FFFF)	0011 1111 1111 1111 (3FFF)	0000 1111 1111 1111 (FFF)
Negative full-scale	$-4 V_{REF}$ or $-2 V_{REF}$	1000 0000 0000 0000 (8000)	0010 0000 0000 0000 (2000)	0000 1000 0000 0000 (800)

7.4 Device Functional Modes

7.4.1 Hardware Mode

With the HW/SW input (pin 62) set low, the device functions are controlled via the pins and, optionally, control register bits C[22:18], C[15:13], and C[9:0].

Generally, the device can be used in hardware mode and switched into software mode to initialize or adjust the control register settings (for example, the internal reference DAC) and switched back to hardware mode thereafter.

7.4.2 Software Mode

When the HW/SW input is set high, the device operates in software mode with functionality set only by the control register bits (corresponding pin settings are ignored).

Device Functional Modes (continued)

If the parallel interface is used, an update of all control register settings is performed by issuing two 16-bit write accesses on pins DB[15:0] in word mode or four 8-bit accesses on pins DB[15:8] in byte mode (to avoid losing data, the entire sequence must be finished before starting a new conversion). Hold \overline{CS} low during the two or four write accesses to completely update the configuration register. Updating only the upper eight bits (C[31:24]) is also possible using a single write access and pins DB[15:8] in both word and byte modes. In word mode, the first write access updates only the upper eight bits and stores the lower eight bits (C[23:16]) for an update that takes place with the second write access along with C[15:0].

If the serial interface is used, input data containing control register contents are required with each read access to the device in this mode (combined read/write access). For initialization purposes, all 32 bits of the register must be set (bit C16 must be set to '1' during that access to allow the update of the entire register content). To minimize switching noise on the interface, an update of the first eight bits (C[31:24]) with the remaining bits held low can be performed thereafter.

Figure 42 illustrates the different control register update options.

7.4.3 Daisy-Chain Mode (in Serial Mode Only)

The serial interface of the ADS855x supports a daisy-chain feature that allows cascading of multiple devices to minimize the board space requirements and simplify routing of the data and control lines. In this case, pins DB5/DCIN_A, DB4/DCIN_B, and DB3/DCIN_C are used as serial data inputs for channels A, B, and C, respectively. Figure 38 shows an example of a daisy-chain connection of three devices sharing a common CONVST line to allow simultaneous sampling of 18 analog channels along with the corresponding timing diagram. To activate the daisy-chain mode, the DC_{EN} pin must be pulled high. As a result of the time specifications t_{S1} , t_{H1} , and t_{D3} , the maximum SCLK frequency that can be used in daisy-chain mode is 27.78 MHz (assuming a 50% duty cycle).

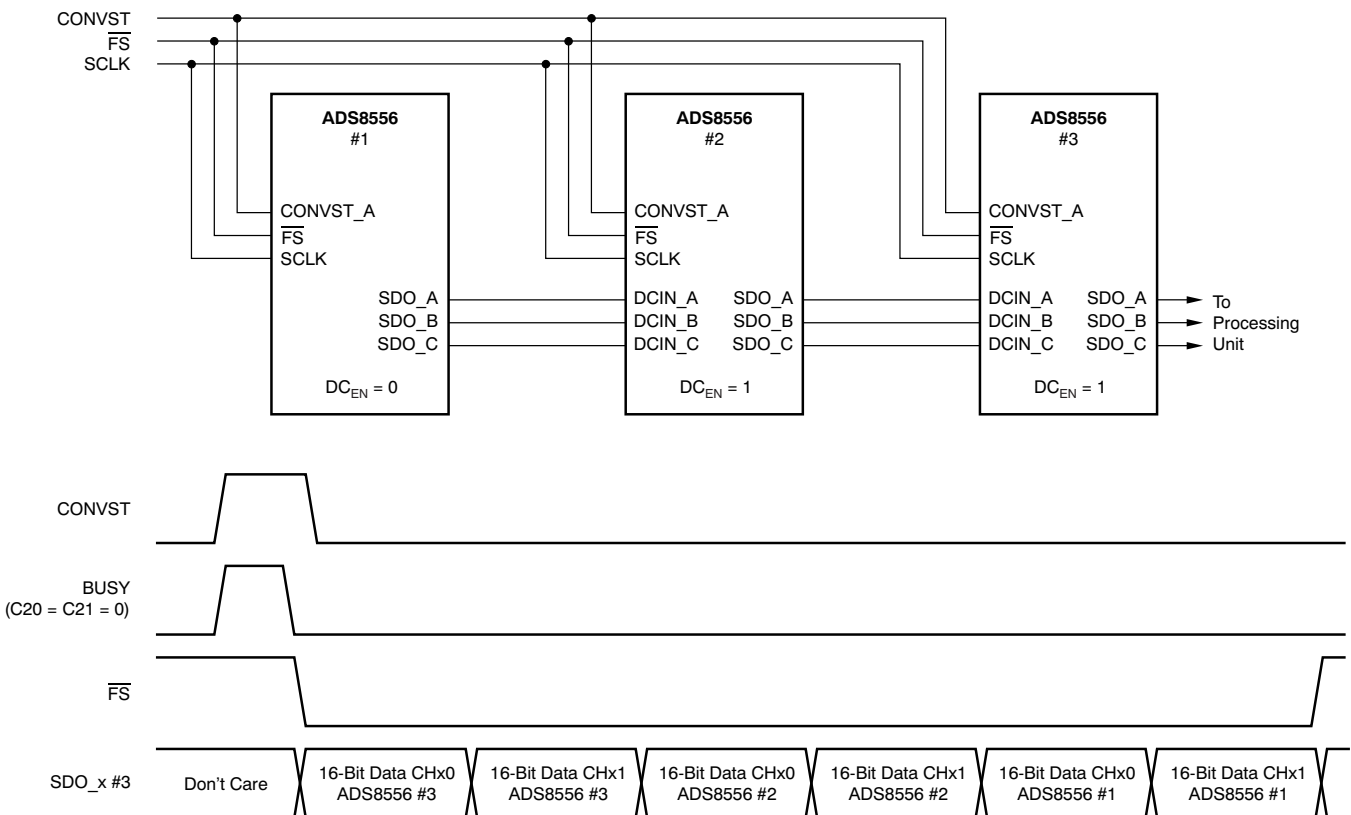
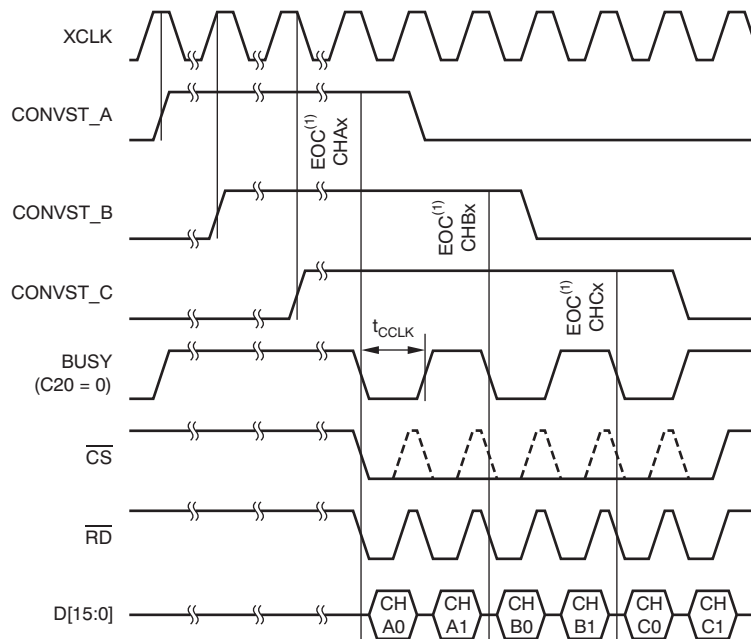

Figure 38. Example of Daisy-Chaining Three ADS8556s

Device Functional Modes (continued)

7.4.4 Sequential Mode (in Software Mode with External Conversion Clock Only)

The three channel pairs of the ADS855x can be run in sequential mode, with the corresponding CONVST_x signals interleaved, when an external clock is used. To activate the device in sequential mode, CR bits C11 (CLKSEL) and C23 (SEQ) must be asserted. In this case, the BUSY output indicates a finished conversion by going low (when C20 = 0) or high (when C20 = 1) for only a single conversion clock cycle in case of ongoing conversions of any other channel pairs. Figure 39 shows the behavior of the BUSY output in this mode. Initiate each conversion start during the high phase of the external clock, as shown in Figure 39. The minimum time required between two CONVST_x pulses is the time required to read the conversion result of a channel (pair).



(1) EOC = end of conversion (internal signal).

Figure 39. Sequential Mode Timing

7.4.5 Reset and Power-Down Modes

The device supports two reset mechanisms: a power-on reset (POR) and a pin-controlled reset (RESET) that can be issued using pin 28. Both the POR and RESET act as a master reset that causes any ongoing conversion to be interrupted, the control register content to be set to the default value, and all channels to be switched into sample mode.

When the device is powered up, the POR sets the device in default mode when AVDD reaches 1.5 V. When the device is powered down, the POR circuit requires AVDD to remain below 125 mV at least 350 ms to ensure proper discharging of internal capacitors and to ensure correct behavior of the device when powered up again. If the AVDD drops below 400 mV but remains above 125 mV (see the *undefined zone* in Figure 40), the internal POR capacitor does not discharge fully and the device requires a pin-controlled reset to perform correctly after the recovery of AVDD.

Device Functional Modes (continued)

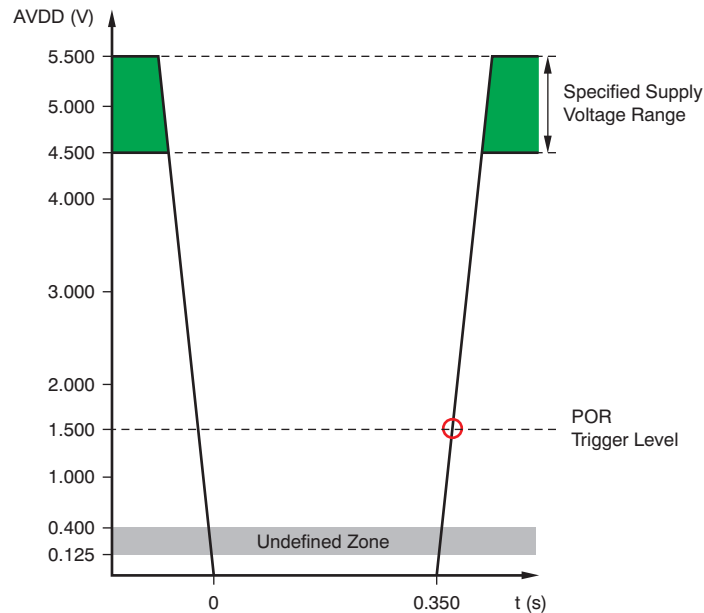

Figure 40. POR: Relevant Voltage Levels

The entire device, except the digital interface, can be powered down by pulling the $\overline{\text{STBY}}$ pin low (pin 24). Because the digital interface section remains active, data can be retrieved when in stand-by mode. To power the part on again, the $\overline{\text{STBY}}$ pin must be brought high. The device is ready to start a new conversion after the 10 ms required to activate and settle the internal circuitry. This user-controlled approach can be used in applications that require lower data throughput rates and lowest power dissipation. The content of CR is not changed during standby mode. A pin-controlled reset is not required after returning to normal operation.

Although the standby mode affects the entire device, each device channel pair can also be individually switched off by setting control register bits C[15:13] (PD_x). When reactivated, the relevant channel pair requires 10 ms to fully settle before starting a new conversion. The internal reference remains active, except all channels are powered down at the same time.

In partial power-down mode, each of the three channel pairs of the ADS855x can be individually put into a power-saving condition that reduces the current requirement to 2 mA per channel pair by bringing the corresponding CONVST_x signal low during an ongoing conversion when BUSY is high. The relevant channel pair is activated again by issuing a RESET pulse (to avoid loss of data from the active channels, this RESET pulse must be generated after retrieving the latest conversion results). The next rising edge of the CONVST_x signal must be issued at least six conversion cycle periods after the reset pulse and starts a new conversion; see Figure 41. The internal reference remains active during the partial power-down mode.

The auto-NAP power-down mode is enabled by asserting the A-NAP bit (C22) in the control register. If the auto-NAP mode is enabled, the ADS855x automatically reduces the current requirement to 6 mA after finishing a conversion; thus, the end of conversion actually activates the power-down mode. Triggering a new conversion by applying a positive CONVST_x edge puts the device back into normal operation, starts the acquisition of the analog input, and automatically starts a new conversion six conversion clock cycles later. Therefore, a complete conversion cycle takes 24.5 conversion clock cycles; thus, the maximum throughput rate in auto-NAP power-down mode is reduced to a maximum of 380 kSPS for the ADS8556, 395 kSPS for the ADS8557, and 420 kSPS for the ADS8558 in serial mode. In parallel mode, the maximum data rates are 500 kSPS for the ADS8556, 530 kSPS for the ADS8557, and 580 kSPS for the ADS8558. The internal reference remains active during the auto-NAP mode. Table 4 compares the analog current requirements of the devices in the different modes.

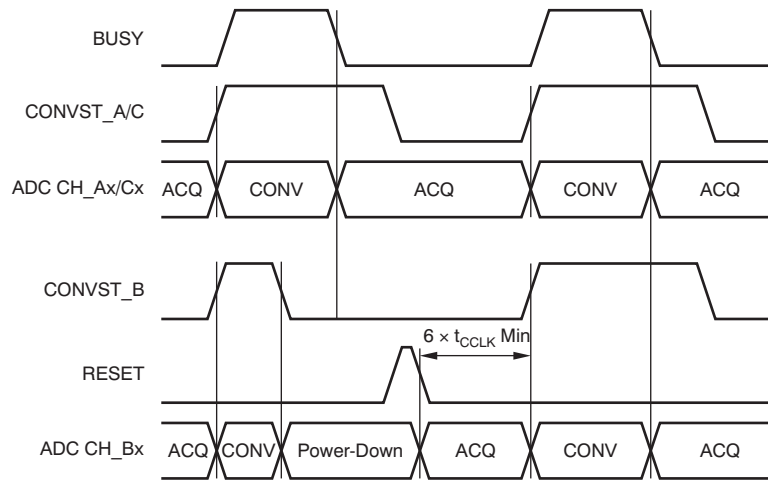
Device Functional Modes (continued)

Figure 41. Partial Power-Down
Table 4. Maximum Analog Current (I_{AVDD}) Demand of the ADS855x

OPERATIONAL MODE	ANALOG CURRENT (I_{AVDD})	ENABLED BY	ACTIVATED BY	NORMAL OPERATION TO POWER-DOWN DELAY	RESUMED BY	POWER-UP TO NORMAL OPERATION DELAY	POWER-UP TO NEXT CONVERSION START TIME	DISABLED BY
Normal operation	12 mA/channel pair (maximum data rate)	Power on	CONVST_x	—	—	—	—	Power off
Partial power-down of channel pair x	2 mA (channel pair x)	Power on	CONVST_x low while BUSY is high	At falling edge of BUSY	RESET pulse	Immediate	$6 \times t_{CCLK}$	Power off
Auto-NAP	6 mA	A-NAP = 1 (CR bit)	Each end of conversion	At falling edge of BUSY	CONVST_x	Immediate	$6 \times t_{CCLK}$	A-NAP = 0 (CR bit)
Power-down of channel pair x	16 μ A (channel pair x)	HW/SW = 1	PD_x = 1 (CR bit)	Immediate	PD_x = 0 (CR bit)	Immediate after completing register update	10 ms	HW/SW = 0
Stand-by	50 μ A	Power on	\overline{STBY} = 0	Immediate	\overline{STBY} = 1	Immediate	10 ms	Power off

7.5 Register Maps

7.5.1 Control Register (CR); Default Value = 0x00003FF

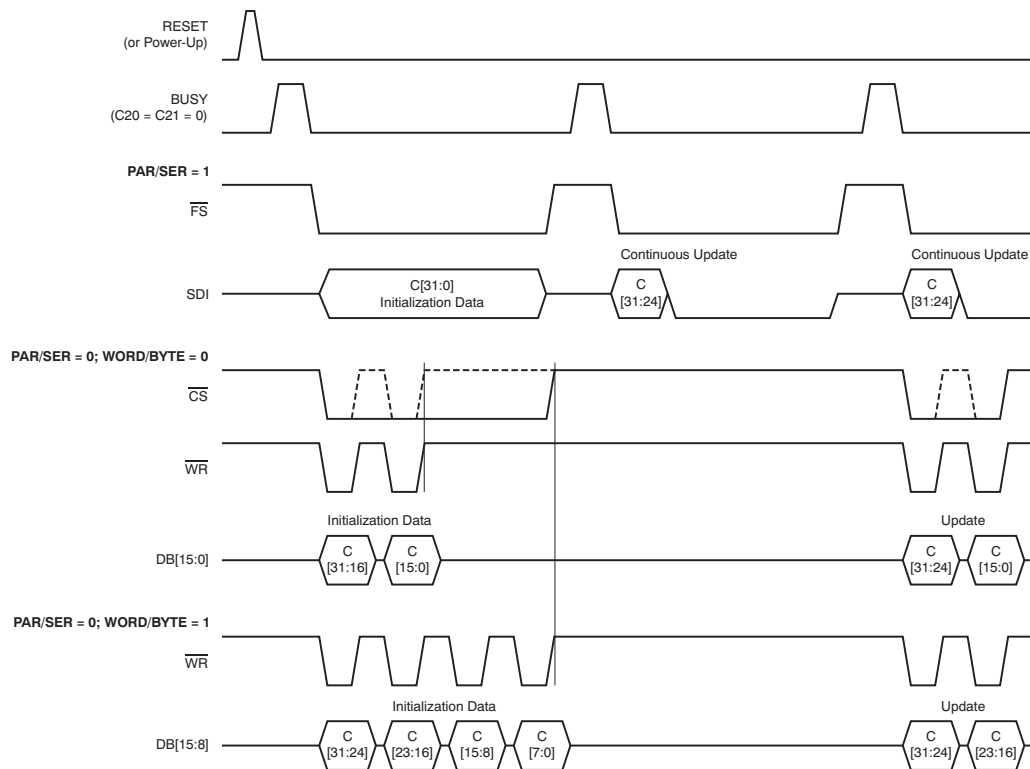
The control register settings can only be changed in software mode and are not affected when switching to hardware mode thereafter. The register values are independent from input pin settings. Changes are active with the rising edge of \overline{WR} in parallel interface mode or with the 32nd falling SCLK edge of the access in which the register content is updated in serial mode. Optionally, the register can also be partially updated by writing only the upper eight bits (C[31:24]). The control register update options are provided in [Figure 42](#). The CR content is defined in [Table 5](#).

Register Maps (continued)

Figure 42. Control Register Update Options
Table 5. Control Register (CR)

BIT	NAME	DESCRIPTION	ACTIVE IN HARDWARE MODE
C31	CH_C	0 = Channel pair C disabled for next conversion (default) 1 = Channel pair C enabled	No
C30	CH_B	0 = Channel pair B disabled for next conversion (default) 1 = Channel pair B enabled	No
C29	CH_A	0 = Channel pair A disabled for next conversion (default) 1 = Channel pair A enabled	No
C28	RANGE_C	0 = Input voltage range selection for channel pair C: 4 V_{REF} (default) 1 = Input voltage range selection for channel pair C: 2 V_{REF}	No
C27	RANGE_B	0 = Input voltage range selection for channel pair B: 4 V_{REF} (default) 1 = Input voltage range selection for channel pair B: 2 V_{REF}	No
C26	RANGE_A	0 = Input voltage range selection for channel pair A: 4 V_{REF} (default) 1 = Input voltage range selection for channel pair A: 2 V_{REF}	No
C25	REF _{EN}	0 = Internal reference source disabled (default) 1 = Internal reference source enabled	No
C24	REFBUF	0 = Internal reference buffers enabled (default) 1 = Internal reference buffers disabled	No
C23	SEQ	0 = Sequential convert start mode disabled (default) 1 = Sequential convert start mode enabled (bit 11 must be '1' in this case)	No
C22	A-NAP	0 = Normal operation (default) 1 = Auto-NAP feature enabled	Yes
C21	BUSY/INT	0 = BUSY/INT pin in normal mode (BUSY) (default) 1 = BUSY/INT pin in interrupt mode (INT)	Yes
C20	BUSY L/H	0 = BUSY active high when INT is active low (default) 1 = BUSY active low when INT is active high	Yes
C19	Don't use	This bit is always set to '0'	—

Register Maps (continued)
Table 5. Control Register (CR) (continued)

BIT	NAME	DESCRIPTION	ACTIVE IN HARDWARE MODE
C18	VREF	0 = Internal reference voltage: 2.5 V (default) 1 = Internal reference voltage: 3 V	Yes
C17	READ_EN	0 = Normal operation (conversion results available on SDO_x) (default) 1 = Control register contents output on SDO_x with next access	Yes
C16	C23:0_EN	0 = Control register bits C[31:24] update only (serial mode only) (default) 1 = Entire control register update enabled (serial mode only)	Yes
C15	PD_C	0 = Normal operation (default) 1 = Power-down for channel pair C enabled (bit 31 must be '0' in this case)	Yes
C14	PD_B	0 = Normal operation (default) 1 = Power-down for channel pair B enabled (bit 30 must be '0' in this case)	Yes
C13	PD_A	0 = Normal operation (default) 1 = Power-down for channel pair A enabled (bit 29 must be '0' in this case)	Yes
C12	Don't use	This bit is always '0'	—
C11	CLKSEL	0 = Normal operation with internal conversion clock (mandatory in hardware mode) (default) 1 = External conversion clock (applied through pin 27) used	No
C10	CLKOUT_EN	0 = Normal operation (default) 1 = Internal conversion clock available at pin 27	No
C9	REFDAC[9]	Bit 9 (MSB) of reference DAC value; default = 1	Yes
C8	REFDAC[8]	Bit 8 of reference DAC value; default = 1	Yes
C7	REFDAC[7]	Bit 7 of reference DAC value; default = 1	Yes
C6	REFDAC[6]	Bit 6 of reference DAC value; default = 1	Yes
C5	REFDAC[5]	Bit 5 of reference DAC value; default = 1	Yes
C4	REFDAC[4]	Bit 4 of reference DAC value; default = 1	Yes
C3	REFDAC[3]	Bit 3 of reference DAC value; default = 1	Yes
C2	REFDAC[2]	Bit 2 of reference DAC value; default = 1	Yes
C1	REFDAC[1]	Bit 1 of reference DAC value; default = 1	Yes
C0	REFDAC[0]	Bit 0 (LSB) of reference DAC value; default = 1	Yes

8 Application and Implementation

NOTE

Information in the following applications sections is not part of the TI component specification, and TI does not warrant its accuracy or completeness. TI's customers are responsible for determining suitability of components for their purposes. Customers should validate and test their design implementation to confirm system functionality.

8.1 Application Information

The ADS855x devices enable high-precision measurement of up to six analog signals simultaneously. The following sections summarize some of the typical use cases for the ADS855x devices and the main steps and components used around the analog-to-digital converter. The design example is carried out specifically using the ADS8556 for a 16-bit data acquisition system.

8.2 Typical Application

This section describes the measurement of electrical variables in a 3-phase power system. The accurate measurement of electrical variables in a power grid is extremely critical because this measurement helps determine the operating status and running quality of the grid. Such accurate measurements also help diagnose problems with the power network, thereby enabling prompt solutions and minimizing down time. The key electrical variables measured in 3-phase power systems are the three line voltages and the three line currents; see [Figure 43](#). These variables enable metrology and power automation systems to determine the amplitude, frequency, and phase information to perform harmonic analysis, power factor calculation, power quality assessment, and so forth.

Typical Application (continued)

8.2.2 Detailed Design Procedure

Figure 44 shows the topology chosen to meet the design requirements. A feedback capacitor C_F is included to provide a low-pass filter characteristic and attenuate signals outside the band of interest.

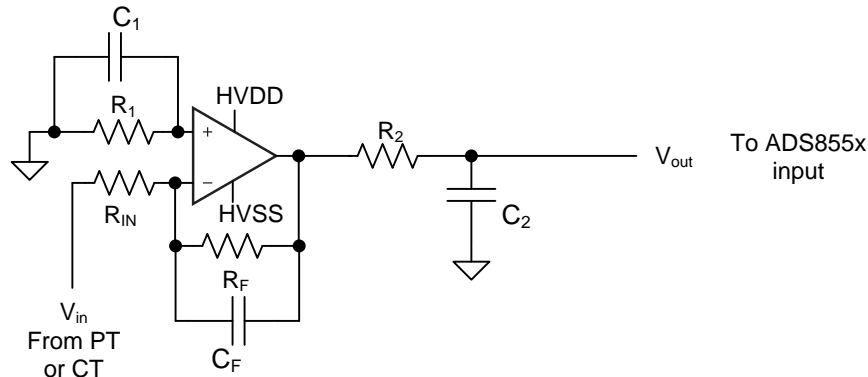

Figure 44. Operational Amplifier in an Inverting Configuration

The potential transformers (PTs) and current transformers (CTs) used in the system depicted in Figure 43 provide the six input variables required. These transformers have a ± 10 -V output range. Although the PTs and CTs provide isolation from the power system, the value of R_{IN} is selected as 100 k Ω to provide an additional, high-impedance safety element to the input of the ADC. Moreover, selecting a low-frequency gain of -1 V/V (as shown in Equation 5) provides a ± 10 -V output that can be fed into the ADS8556 device; therefore, the value of R_F is selected as 100 k Ω .

$$V_{out}|_{Low f} = -\frac{R_F}{R_{IN}}V_{in} = -\frac{100 \text{ k}\Omega}{100 \text{ k}\Omega}V_{in} = -V_{in} \quad (5)$$

The primary goal of the acquisition system depicted in Figure 43 is to measure up to 20 harmonics in a 60-Hz power network. Thus, the analog front-end must have sufficient bandwidth to detect signals up to 1260 Hz, as shown in Equation 6.

$$f_{MAX} = (20 + 1)60 \text{ Hz} = 1260 \text{ Hz} \quad (6)$$

Based on the bandwidth found in Equation 6, the ADS8556 device is set to simultaneously sample all six channels at 15.36 kSPS, which provides enough samples to clearly resolve even the highest harmonic required.

The passband of the configuration shown in Figure 44 is determined by the -3 -dB frequency according to Equation 7. The value of C_F is selected as 820 pF, which is a standard capacitance value available in 0603 size (surface-mount component) and such values, combined with that of R_F , result in sufficient bandwidth to accommodate the required 20 harmonics (at 60 Hz).

$$f_{-3dB} = \frac{1}{2\pi R_F C_F} = \frac{1}{2\pi (100 \text{ k}\Omega)(820 \text{ pF})} = 1940 \text{ Hz} \quad (7)$$

The value of R_1 is selected as the parallel combination of R_{IN} and R_F to prevent the input bias current of the operational amplifier from generating an offset error.

The value of component C_1 is chosen as 0.1 μ F to provide a low-impedance path for noise signals that can be picked up by R_1 ; this 0.1- μ F capacitance value improves the EMI robustness and noise performance of the system.

The OPA2277 device is chosen for its low input offset voltage, low drift, bipolar swing, sufficient gain-bandwidth product and low quiescent current. For additional information on the procedure to select SAR ADC input drivers, see *16-bit 400KSPS 4-Ch. Multiplexed Data Acquisition Ref Design for High Voltage Inputs, Low Distortion, TIPD151*.

The charge injection damping circuit is composed of R_2 (49.9 Ω) and C_2 (370 pF); these components reject high-frequency noise and meet the settling requirements of the ADS8556 device input.

Typical Application (continued)

Figure 45 shows the reference block used in this design.

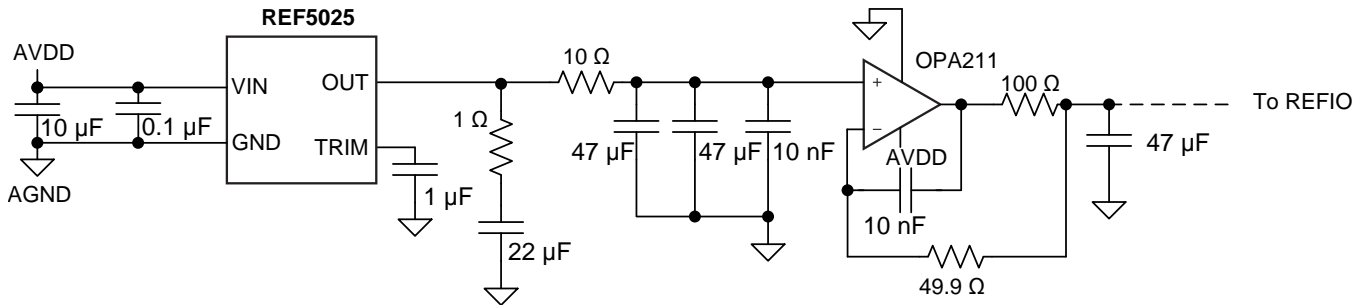

Figure 45. Reference Block

For more information on the design of charge injection damping circuits and reference driving circuits for SAR ADCs, consult the reference guide *Power-optimized 16-bit 1MSPS Data Acquisition Block for Lowest Distortion and Noise Reference Design*, TIDU014.

8.2.3 Application Curve

Figure 46 shows the frequency spectrum of the data acquired by the ADS8556 device for a sinusoidal, 20-V_{PP} input at 60 Hz.

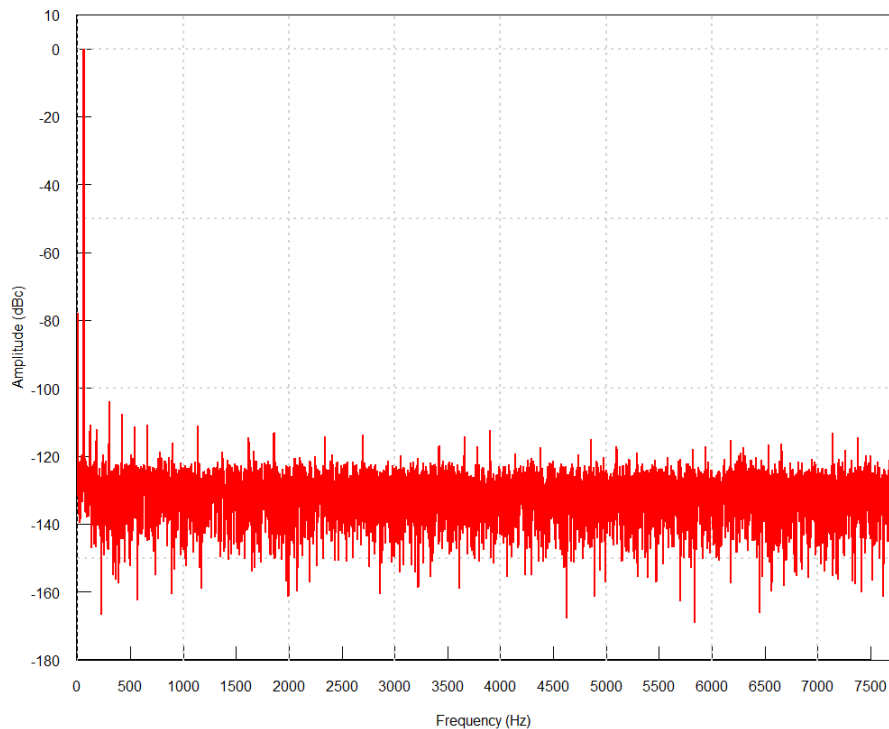

Figure 46. Frequency Spectrum for a Sinusoidal 20-V_{PP} Signal at 60 Hz

The ac performance parameters are:

- SNR: 91.9 dB
- THD: -99.68 dB
- SNDR: 91.23 dB
- SFDR: 103.65 dB

9 Power Supply Recommendations

The ADS855x requires four separate supplies: the analog supply for the ADC (AVDD), the buffer I/O supply for the digital interface (BVDD), and the high-voltage supplies driving the analog input circuitry (HVDD and HVSS). Generally, there are no specific requirements with regard to the power sequencing of the device. However, when HVDD is supplied before AVDD, the internal ESD structure conducts, increasing IHVDD beyond the specified value.

The AVDD supply provides power to the internal circuitry of the ADC. AVDD can be set in the range of 4.5 V to 5.5 V. Because the supply current of the device is typically 30 mA, a passive filter cannot be used between the digital board supply of the application and the AVDD pin. A linear regulator is recommended to generate the analog supply voltage. Decouple each AVDD pin to AGND with a 100-nF capacitor. In addition, place a single 10- μ F capacitor close to the device but without compromising the placement of the smaller capacitor. Optionally, each supply pin can be decoupled using a 1- μ F ceramic capacitor without the requirement for a 10- μ F capacitor.

The BVDD supply is only used to drive the digital I/O buffers and can be set in the range of 2.7 V to 5.5 V. This range allows the device to interface with most state-of-the-art processors and controllers. To limit the noise energy from the external digital circuitry to the device, filter BVDD. A 10- Ω resistor can be placed between the external digital circuitry and the device because the current drawn is typically below 2 mA (depending on the external loads). Place a bypass ceramic capacitor of 1- μ F (or alternatively, a pair of 100-nF and 10- μ F capacitors) between the BVDD pin and pin 8.

The high-voltage supplies (HVSS and HVDD) are connected to the analog inputs. Noise and glitches on these supplies directly couple into the input signals. Place a 100-nF ceramic decoupling capacitor, located as close to the device as possible, between each of pins 30, 31, and AGND. An additional 10- μ F capacitor is used that must be placed close to the device but without compromising the placement of the smaller capacitor.

10 Layout

10.1 Layout Guidelines

All GND pins must be connected to a clean ground reference. Keep this connection as short as possible to minimize the inductance of this path. Using vias connecting the pads directly to the ground plane is recommended. In designs without ground planes, keep the ground trace as wide as possible. Avoid connections that are too close to the grounding point of a microcontroller or digital signal processor.

Depending on the circuit density on the board, placement of the analog and digital components, and the related current loops, a single solid ground plane for the entire printed circuit board (PCB) or a dedicated analog ground area can be used. In case of a separated analog ground area, ensure a low-impedance connection between the analog and digital ground of the ADC by placing a bridge underneath (or next) to the ADC. Otherwise, even short undershoots on the digital interface lower than –300 mV lead to the conduction of ESD diodes causing current flow through the substrate and degrading the analog performance.

During PCB layout, care must be taken to avoid any return currents crossing sensitive analog areas or signals.

10.2 Layout Example

Figure 47 shows a layout recommendation for the ADS855x along with the proper decoupling and reference capacitor placement and connections.

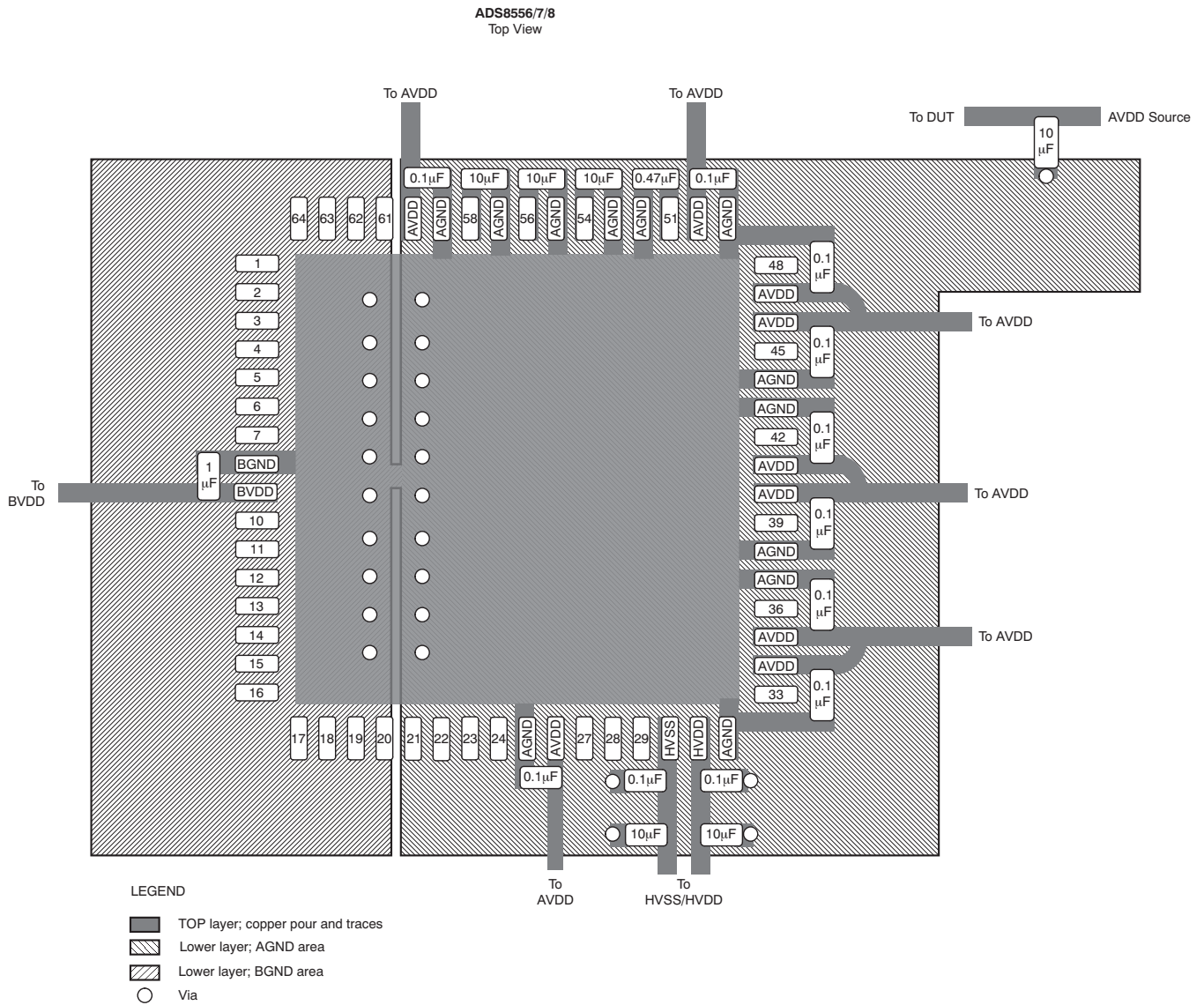

- (1) All 0.1- μ F, 0.47- μ F, and 1- μ F capacitors must be placed as close to the device as possible.
- (2) All 10- μ F capacitors must be close to the device but without compromising the placement of the smaller capacitors.

Figure 47. Layout Recommendation

11 Device and Documentation Support

11.1 Documentation Support

11.1.1 Related Documentation

For related documentation see the following:

- OPAx277 Data Sheet, [SBOS079](#)
- REF5025 Data Sheet, [SBOS410](#)
- *16-bit 400KSPS 4-Ch. Multiplexed Data Acquisition Ref Design for High Voltage Inputs, Low Distortion*, [TIPD151](#)
- *Power-optimized 16-bit 1MSPS Data Acquisition Block for Lowest Distortion and Noise Reference Design*, [TIDU014](#)

11.2 Related Links

The table below lists quick access links. Categories include technical documents, support and community resources, tools and software, and quick access to sample or buy.

Table 6. Related Links

PARTS	PRODUCT FOLDER	SAMPLE & BUY	TECHNICAL DOCUMENTS	TOOLS & SOFTWARE	SUPPORT & COMMUNITY
ADS8556	Click here	Click here	Click here	Click here	Click here
ADS8557	Click here	Click here	Click here	Click here	Click here
ADS8558	Click here	Click here	Click here	Click here	Click here

11.3 Community Resources

The following links connect to TI community resources. Linked contents are provided "AS IS" by the respective contributors. They do not constitute TI specifications and do not necessarily reflect TI's views; see TI's [Terms of Use](#).

TI E2E™ Online Community *TI's Engineer-to-Engineer (E2E) Community*. Created to foster collaboration among engineers. At e2e.ti.com, you can ask questions, share knowledge, explore ideas and help solve problems with fellow engineers.

Design Support *TI's Design Support* Quickly find helpful E2E forums along with design support tools and contact information for technical support.

11.4 Trademarks

E2E is a trademark of Texas Instruments.
All other trademarks are the property of their respective owners.

11.5 Electrostatic Discharge Caution



These devices have limited built-in ESD protection. The leads should be shorted together or the device placed in conductive foam during storage or handling to prevent electrostatic damage to the MOS gates.

11.6 Glossary

[SLYZ022](#) — *TI Glossary*.

This glossary lists and explains terms, acronyms, and definitions.

12 Mechanical, Packaging, and Orderable Information

The following pages include mechanical, packaging, and orderable information. This information is the most current data available for the designated devices. This data is subject to change without notice and revision of this document. For browser-based versions of this data sheet, refer to the left-hand navigation.

PACKAGING INFORMATION

Orderable Device	Status (1)	Package Type	Package Drawing	Pins	Package Qty	Eco Plan (2)	Lead finish/ Ball material (6)	MSL Peak Temp (3)	Op Temp (°C)	Device Marking (4/5)	Samples
ADS8556IPM	ACTIVE	LQFP	PM	64	160	RoHS & Green	NIPDAU	Level-3-260C-168 HR	-40 to 125	ADS 8556I	Samples
ADS8556IPMR	ACTIVE	LQFP	PM	64	1000	RoHS & Green	NIPDAU	Level-3-260C-168 HR	-40 to 125	ADS 8556I	Samples
ADS8557IPM	ACTIVE	LQFP	PM	64	160	RoHS & Green	NIPDAU	Level-3-260C-168 HR	-40 to 125	ADS 8557I	Samples
ADS8557IPMR	ACTIVE	LQFP	PM	64	1000	RoHS & Green	NIPDAU	Level-3-260C-168 HR	-40 to 125	ADS 8557I	Samples
ADS8558IPM	ACTIVE	LQFP	PM	64	160	RoHS & Green	NIPDAU	Level-3-260C-168 HR	-40 to 125	ADS 8558I	Samples
ADS8558IPMR	ACTIVE	LQFP	PM	64	1000	RoHS & Green	NIPDAU	Level-3-260C-168 HR	-40 to 125	ADS 8558I	Samples

(1) The marketing status values are defined as follows:

ACTIVE: Product device recommended for new designs.

LIFEBUY: TI has announced that the device will be discontinued, and a lifetime-buy period is in effect.

NRND: Not recommended for new designs. Device is in production to support existing customers, but TI does not recommend using this part in a new design.

PREVIEW: Device has been announced but is not in production. Samples may or may not be available.

OBSELETE: TI has discontinued the production of the device.

(2) **RoHS:** TI defines "RoHS" to mean semiconductor products that are compliant with the current EU RoHS requirements for all 10 RoHS substances, including the requirement that RoHS substance do not exceed 0.1% by weight in homogeneous materials. Where designed to be soldered at high temperatures, "RoHS" products are suitable for use in specified lead-free processes. TI may reference these types of products as "Pb-Free".

RoHS Exempt: TI defines "RoHS Exempt" to mean products that contain lead but are compliant with EU RoHS pursuant to a specific EU RoHS exemption.

Green: TI defines "Green" to mean the content of Chlorine (Cl) and Bromine (Br) based flame retardants meet JS709B low halogen requirements of <=1000ppm threshold. Antimony trioxide based flame retardants must also meet the <=1000ppm threshold requirement.

(3) MSL, Peak Temp. - The Moisture Sensitivity Level rating according to the JEDEC industry standard classifications, and peak solder temperature.

(4) There may be additional marking, which relates to the logo, the lot trace code information, or the environmental category on the device.

(5) Multiple Device Markings will be inside parentheses. Only one Device Marking contained in parentheses and separated by a "~" will appear on a device. If a line is indented then it is a continuation of the previous line and the two combined represent the entire Device Marking for that device.

⁽⁶⁾ Lead finish/Ball material - Orderable Devices may have multiple material finish options. Finish options are separated by a vertical ruled line. Lead finish/Ball material values may wrap to two lines if the finish value exceeds the maximum column width.

Important Information and Disclaimer:The information provided on this page represents TI's knowledge and belief as of the date that it is provided. TI bases its knowledge and belief on information provided by third parties, and makes no representation or warranty as to the accuracy of such information. Efforts are underway to better integrate information from third parties. TI has taken and continues to take reasonable steps to provide representative and accurate information but may not have conducted destructive testing or chemical analysis on incoming materials and chemicals. TI and TI suppliers consider certain information to be proprietary, and thus CAS numbers and other limited information may not be available for release.

In no event shall TI's liability arising out of such information exceed the total purchase price of the TI part(s) at issue in this document sold by TI to Customer on an annual basis.

TAPE AND REEL INFORMATION

QUADRANT ASSIGNMENTS FOR PIN 1 ORIENTATION IN TAPE

*All dimensions are nominal

Device	Package Type	Package Drawing	Pins	SPQ	Reel Diameter (mm)	Reel Width W1 (mm)	A0 (mm)	B0 (mm)	K0 (mm)	P1 (mm)	W (mm)	Pin1 Quadrant
ADS8556IPMR	LQFP	PM	64	1000	330.0	24.4	13.0	13.0	2.1	16.0	24.0	Q2
ADS8557IPMR	LQFP	PM	64	1000	330.0	24.4	13.0	13.0	2.1	16.0	24.0	Q2
ADS8558IPMR	LQFP	PM	64	1000	330.0	24.4	13.0	13.0	2.1	16.0	24.0	Q2

TAPE AND REEL BOX DIMENSIONS

*All dimensions are nominal

Device	Package Type	Package Drawing	Pins	SPQ	Length (mm)	Width (mm)	Height (mm)
ADS8556IPMR	LQFP	PM	64	1000	350.0	350.0	43.0
ADS8557IPMR	LQFP	PM	64	1000	350.0	350.0	43.0
ADS8558IPMR	LQFP	PM	64	1000	350.0	350.0	43.0

PM0064A



PACKAGE OUTLINE

LQFP - 1.6 mm max height

PLASTIC QUAD FLATPACK



4215162/A 03/2017

NOTES:

1. All linear dimensions are in millimeters. Any dimensions in parenthesis are for reference only. Dimensioning and tolerancing per ASME Y14.5M.
2. This drawing is subject to change without notice.
3. This dimension does not include mold flash, protrusions, or gate burrs. Mold flash, protrusions, or gate burrs shall not exceed 0.15 mm per side.
4. Reference JEDEC registration MS-026.

EXAMPLE BOARD LAYOUT

PM0064A

LQFP - 1.6 mm max height

PLASTIC QUAD FLATPACK



LAND PATTERN EXAMPLE
EXPOSED METAL SHOWN
SCALE:8X

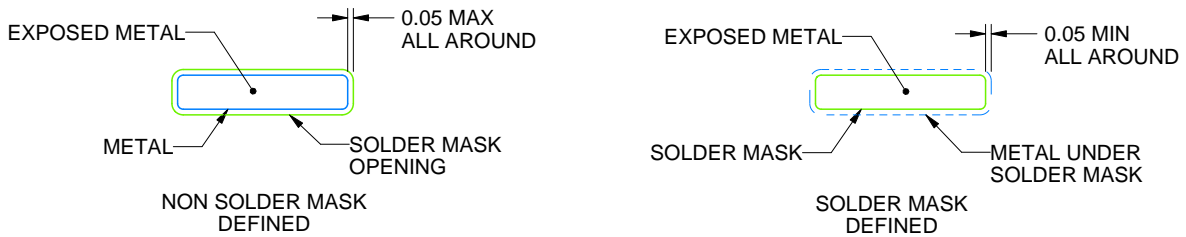

SOLDER MASK DETAILS

4215162/A 03/2017

NOTES: (continued)

5. Publication IPC-7351 may have alternate designs.
6. Solder mask tolerances between and around signal pads can vary based on board fabrication site.
7. For more information, see Texas Instruments literature number SLMA004 (www.ti.com/lit/slma004).

EXAMPLE STENCIL DESIGN

PM0064A

LQFP - 1.6 mm max height

PLASTIC QUAD FLATPACK

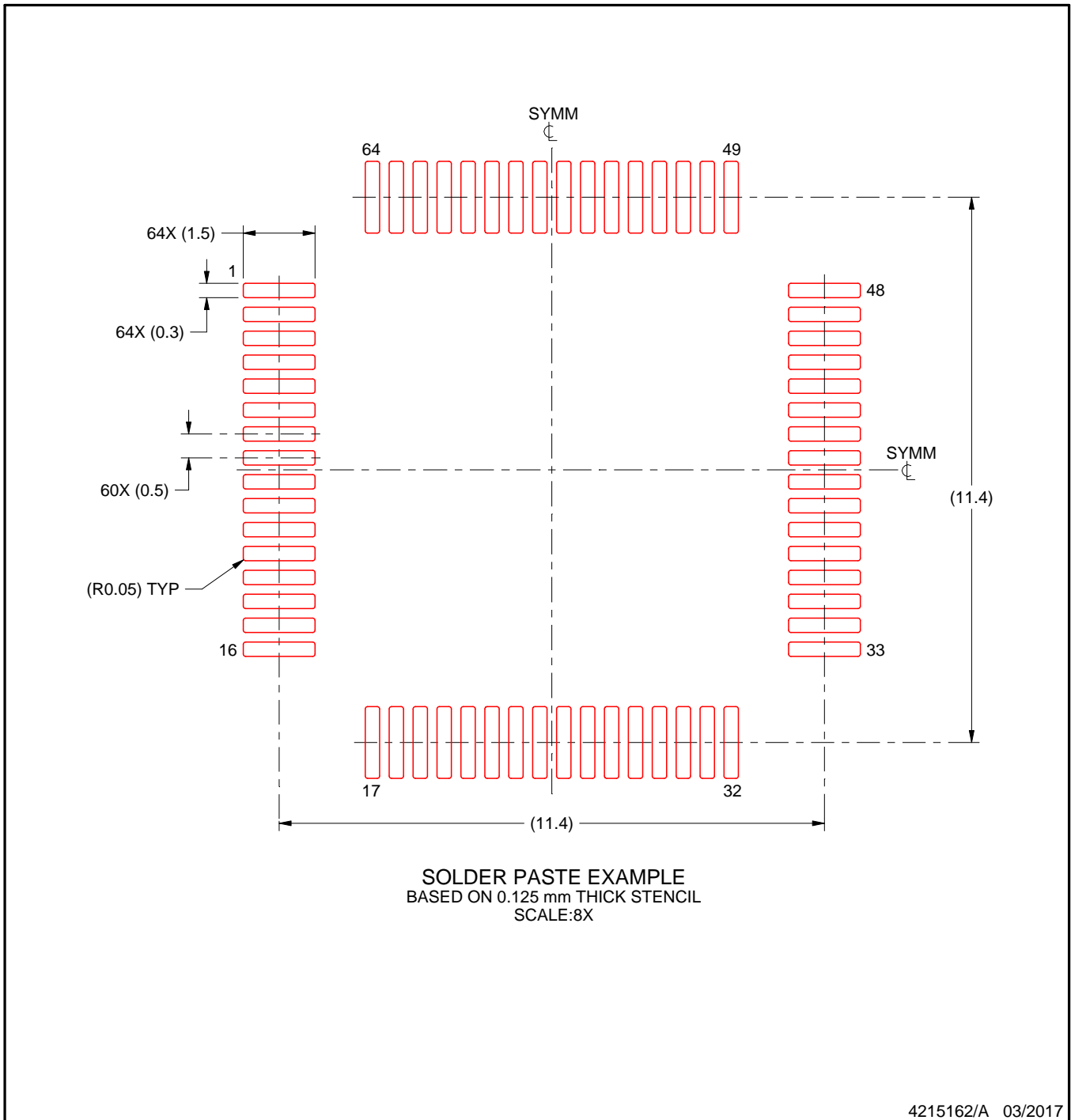

NOTES: (continued)

8. Laser cutting apertures with trapezoidal walls and rounded corners may offer better paste release. IPC-7525 may have alternate design recommendations.
9. Board assembly site may have different recommendations for stencil design.

IMPORTANT NOTICE AND DISCLAIMER

TI PROVIDES TECHNICAL AND RELIABILITY DATA (INCLUDING DATASHEETS), DESIGN RESOURCES (INCLUDING REFERENCE DESIGNS), APPLICATION OR OTHER DESIGN ADVICE, WEB TOOLS, SAFETY INFORMATION, AND OTHER RESOURCES "AS IS" AND WITH ALL FAULTS, AND DISCLAIMS ALL WARRANTIES, EXPRESS AND IMPLIED, INCLUDING WITHOUT LIMITATION ANY IMPLIED WARRANTIES OF MERCHANTABILITY, FITNESS FOR A PARTICULAR PURPOSE OR NON-INFRINGEMENT OF THIRD PARTY INTELLECTUAL PROPERTY RIGHTS.

These resources are intended for skilled developers designing with TI products. You are solely responsible for (1) selecting the appropriate TI products for your application, (2) designing, validating and testing your application, and (3) ensuring your application meets applicable standards, and any other safety, security, or other requirements. These resources are subject to change without notice. TI grants you permission to use these resources only for development of an application that uses the TI products described in the resource. Other reproduction and display of these resources is prohibited. No license is granted to any other TI intellectual property right or to any third party intellectual property right. TI disclaims responsibility for, and you will fully indemnify TI and its representatives against, any claims, damages, costs, losses, and liabilities arising out of your use of these resources.

TI's products are provided subject to TI's Terms of Sale (www.ti.com/legal/termsofsale.html) or other applicable terms available either on ti.com or provided in conjunction with such TI products. TI's provision of these resources does not expand or otherwise alter TI's applicable warranties or warranty disclaimers for TI products.

Mailing Address: Texas Instruments, Post Office Box 655303, Dallas, Texas 75265
Copyright © 2020, Texas Instruments Incorporated