

### SM7 Varistor Series

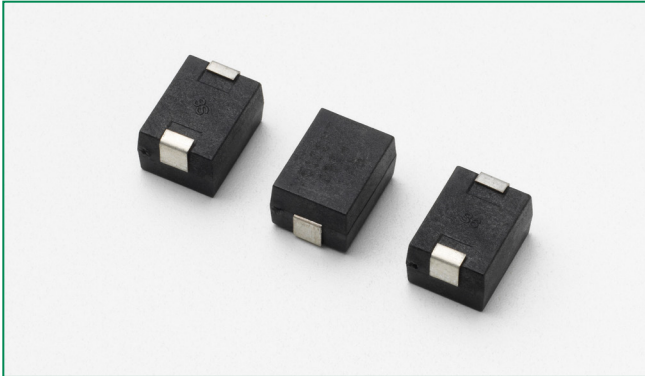

25-07656



#### Description

The Littelfuse SM7 is a plastic-encapsulated surface mount MOV in a PPS material molded package with tin-plated terminal which is fully qualified in lead free soldering and available for both reflow and wave soldering process. SM7 is constructed with 7mm varistor element disc. Its maximum operating ambient temperature is 85°C with peak pulse current of 1200A.

#### Features

- Electrical equivalent to leaded types LA/ZA series
- AC Voltage Rating 50 to 510VAC rms
- No De-Rating up to 85°C ambient
- Good solderability
- Available in tape and reel
- Application of AC power meters
- Lead free and RoHS compliant

#### Agency Approvals

Agency	Agency Approval	Agency File Number
	UL1449	E320116

#### Absolute Maximum Ratings

• For ratings of individual members of a series, see Device Ratings and Specifications chart

Continuous	SM7 Series	Units
Steady State Applied Voltage:		
AC Voltage Range ( $V_{M(AC)RMS}$ )	50 to 510	V
DC Voltage Range ( $V_{M(DC)}$ )	68 to 675	V
Transients:		
Peak Pulse Current ( $I_{TM}$ ) For 8/20 $\mu$ s Current Wave (See Figure 2)	1200	A
Single Pulse Energy Range For 10/1000 $\mu$ s Current Wave ( $W_{TM}$ )	10 to 40	J
Operating Ambient Temperature Range ( $T_A$ )	-40 to +85	°C
Storage Temperature Range ( $T_{STG}$ )	-55 to +125	°C
Temperature Coefficient ( $\alpha$ ) of Clamping Voltage ( $V_C$ ) at Specified Test Current	<0.01	%/°C
Hi-Pot Encapsulation (COATING Isolation Voltage Capability) (Dielectric must withstand indicated DC voltage for one minute per MIL-STD 202, Method 301)	2500	V
COATING Insulation Resistance	1000	M $\Omega$

*CAUTION: Stresses above those listed in "Absolute Maximum Ratings" may cause permanent damage to the device. This is a stress only rating and operation of the device at these or any other conditions above those indicated in the operational sections of this specification is not implied.*

#### Additional Information



[Datasheet](#)



[Resources](#)



[Samples](#)

**SM7 Series Ratings & Specifications**

Part Number	Maximum Rating (85°C)				Specifications (25°C)				
	Continuous		Transient		Varistor Voltage at 1mA DC Test Current		Maximum Clamping Voltage 8 x 20 μs		Typical Capacitance f = 1MHz
	V <sub>RMS</sub>	V <sub>DC</sub>	Energy 10 x 1000 μs	Peak Current 8 x 20 μs					
V <sub>M(AC)</sub> (V)	V <sub>M(DC)</sub> (V)	W <sub>TM</sub> (J)	I <sub>TM</sub> (A)	V <sub>NOM</sub> Min (V)	V <sub>NOM</sub> Max (V)	V <sub>C</sub> (V)	I <sub>PK</sub> (A)	C (pF)	
V50SM7	50	68	4	1200	73	91	135	10	700
V60SM7	60	81	5	1200	90	110	165	10	600
V115SM7	115	153	10	1200	162	198	300	10	200
V130SM7	130	175	11	1200	184	228	340	10	180
V140SM7	140	180	12	1200	198	242	360	10	160
V150SM7	150	200	13	1200	212	268	395	10	150
V175SM7	175	225	15	1200	247	303	455	10	130
V230SM7	230	300	20	1200	324	396	595	10	100
V250SM7	250	330	21	1200	354	429	650	10	90
V275SM7	275	369	23	1200	389	473	710	10	80
V300SM7	300	405	25	1200	420	517	775	10	70
V320SM7	320	420	25	1200	462	565	850	10	65
V385SM7	385	505	27	1200	558	682	1025	10	60
V420SM7	420	560	30	1200	610	748	1120	10	55
V460SM7	460	615	37	1200	640	790	1190	10	55
V480SM7	480	640	35	1200	670	825	1240	10	50
V510SM7	510	675	40	1200	735	910	1200	10	45

**Product Dimensions**

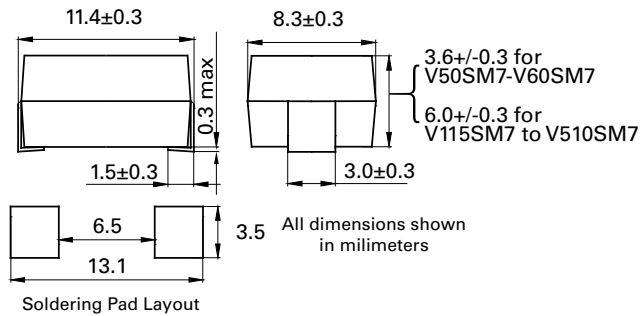

**Part Numbering System**

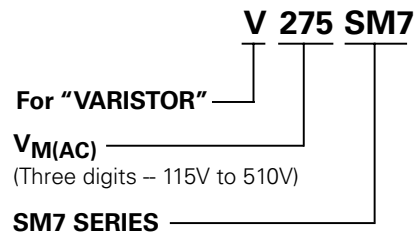

**Lead (Pb) Soldering Recommendations**

The principal techniques used for the soldering of components in surface mount technology are IR Re-flow and Wave soldering. Typical profiles are shown on the right.

The terminals of SM7 series devices are tin plated copper, and the recommended solder is 62/36/2 (Sn/Pb/Ag), 60/40 (Sn/Pb) or 63/37 (Sn/Pb). Littelfuse also recommends an RMA solder flux.

Wave soldering is the most strenuous of the processes. To avoid the possibility of generating stresses due to thermal shock, a preheat stage in the soldering process is recommended, and the peak temperature of the solder process should be rigidly controlled.

When using a reflow process, care should be taken to ensure that the SM7 chip is not subjected to a thermal gradient steeper than 4 degrees per second; the ideal gradient being 2 degrees per second. During the soldering process, preheating to within 100 degrees of the solder's peak temperature is essential to minimize thermal shock.

Once the soldering process has been completed, it is still necessary to ensure that any further thermal shocks are avoided. One possible cause of thermal shock is hot printed circuit boards being removed from the solder process and subjected to cleaning solvents at room temperature. The boards must be allowed to cool gradually to less than 50°C before cleaning.

**Reflow Solder Profile**

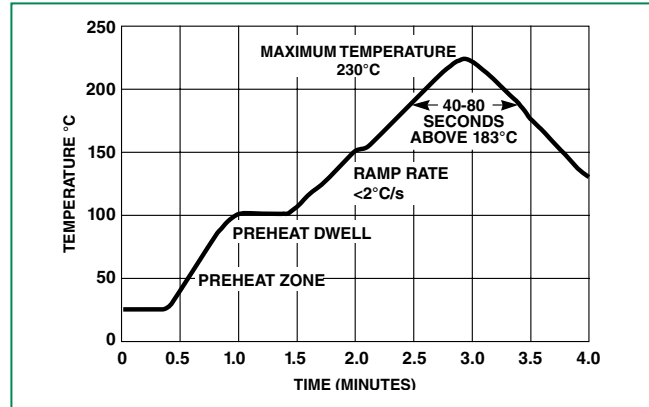

**Wave Solder Profile**

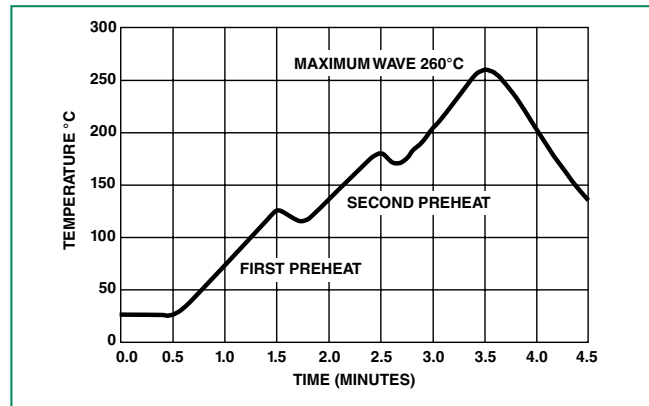

**Lead-free (Pb-free) Soldering Recommendations**

The terminals of SM7 series devices are tin plated copper, and the recommended Lead-free solder is 96.5/3.0/0.5 (SnAgCu) with an RMA flux, though there is a wide selection of pastes and fluxes available that should be compatible.

The reflow profile must be constrained by the maximums in the Lead-free Reflow Profile. For Lead-free Wave soldering, the Wave Solder Profile still applies.

Note: the Lead-free paste, flux and profile were used for evaluation purposes by Littelfuse, based upon industry standards and practices. There are multiple choices of all three available, it is advised that the customer explores the optimum combination for their process as processes vary considerably from site to site.

**Lead-free Re-flow Solder Profile**

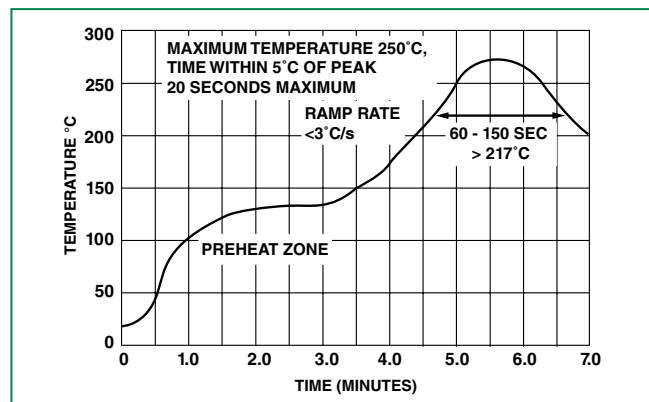

### Peak Current, Energy and Power Derating Curve

For applications exceeding 85°C ambient temperature, the peak surge current and energy ratings must be reduced as shown below

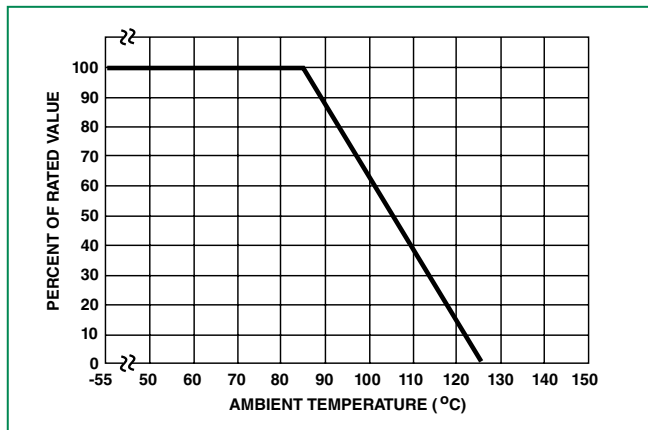

### Peak Pulse Current Test Waveform for Clamping Voltage

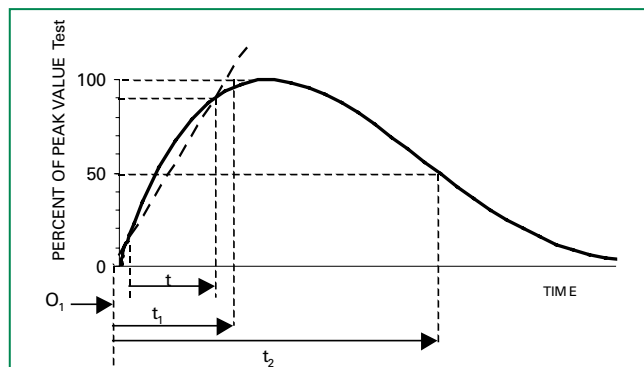

$O_1$  = Virtual Origin of Wave  
 $T_1$  = Time from 10% to 90% of Peak  
 $T_{r1}$  = Rise Time =  $1.25 \times T$   
 $T_{d2}$  = Decay Time

**Example** - For an  $8/20 \mu s$  Current Waveform:  
 $8 \mu s = T_{r1}$  = Rise Time  
 $20 \mu s = T_{d2}$  = Decay Time

### V-I Limit Curves

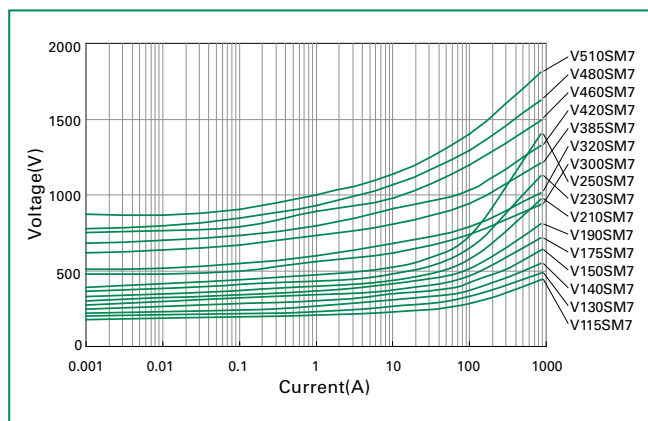

NOTE: If pulse ratings are exceeded, a shift of  $V_{N(DC)}$  (at specified current) of more than  $\pm 10\%$  could result. This type of shift, which normally results in a decrease of  $V_{N(DC)}$ , may result in the device not meeting the original published specifications, but it does not prevent the device from continuing to function, and to provide ample protection.

### Pulse Rating Curves

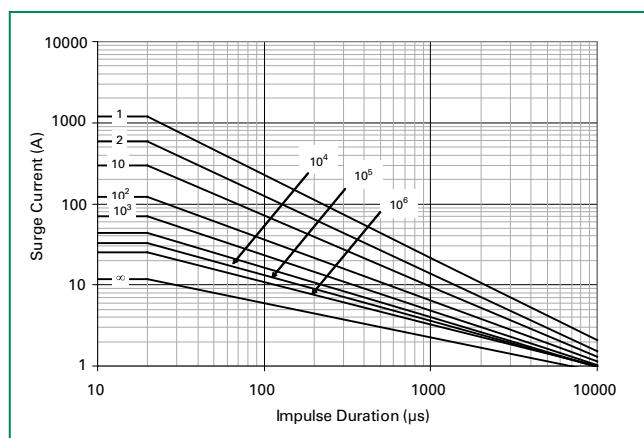

### Physical Specifications

<b>Lead Material</b>	Folded Tin Plated Metal Leads
<b>Soldering Characteristics</b>	J-STD-002
<b>Coating</b>	Molded Plastic Meets UL94 V-0 Requirement

### Environmental Specifications

<b>Operating Ambient Temperature Range (<math>T_A</math>)</b>	-40°C to +85°C
<b>Storage Temperature Range (<math>T_{STG}</math>)</b>	-55°C to 125°C
<b>Solvent Resistance</b>	MIL STD 202, Method 215
<b>Moisture Sensitivity</b>	Level 1, J-STD-020 (V115SM7 to V510SM7)

**Disclaimer Notice** - Information furnished is believed to be accurate and reliable. However, users should independently evaluate the suitability of and test each product selected for their own applications. Littelfuse products are not designed for, and may not be used in, all applications. Read complete Disclaimer Notice at [www.littelfuse.com/disclaimer-electronics](http://www.littelfuse.com/disclaimer-electronics).

**Tape & Reel Specifications for V50SM7 and V60SM7**

**Carrier Tape**

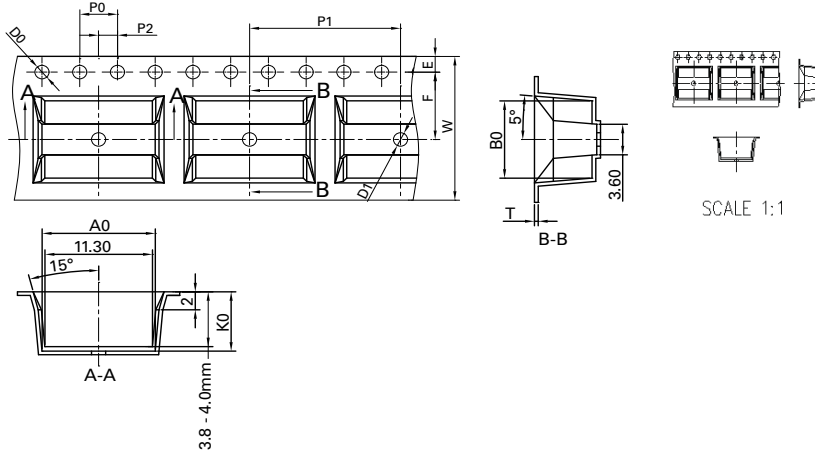

	mm
<b>W</b>	16.00±0.30
<b>T</b>	0.40±0.05
<b>A0</b>	11.80±0.10
<b>B0</b>	8.60±0.10
<b>K0</b>	4.80±0.10
<b>E</b>	1.75±0.10
<b>F</b>	7.50±0.10
<b>P0</b>	4.00±0.10
<b>P1</b>	16.00±0.10
<b>P2</b>	2.00±0.10
<b>D0</b>	ø1.50 +0.10/-0
<b>D1</b>	ø1.50 +0.10/-0

**Plastic Reel**

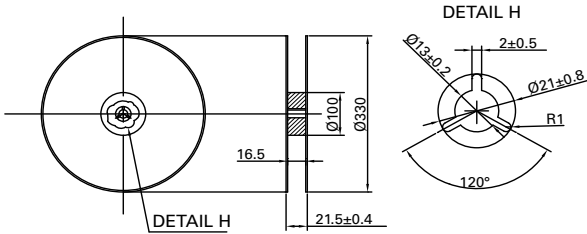

- NOTES:
- 1) All dimensions per EIA-481-c
  - 2) 10 pitches cumulative tolerance on tape ±0.20mm
  - 3) Quantity per 13 inch (330 mm) reel: 600 pcs

**Tape & Reel Specifications for V115SM7 to V510SM7**

**Carrier Tape**

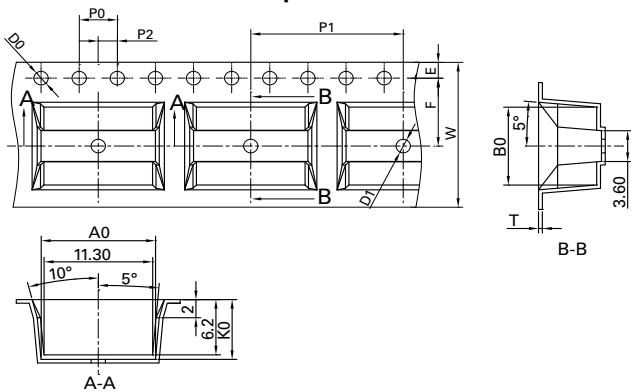

	mm
<b>W</b>	16.00±0.30
<b>T</b>	0.40±0.05
<b>A0</b>	11.80±0.10
<b>B0</b>	8.60±0.10
<b>K0</b>	6.80±0.10
<b>E</b>	1.75±0.10
<b>F</b>	7.50±0.10
<b>P0</b>	4.00±0.10
<b>P1</b>	16.00±0.10
<b>P2</b>	2.00±0.10
<b>D0</b>	ø1.50 +0.10/-0
<b>D1</b>	ø1.50 +0.10/-0

**Plastic Reel**

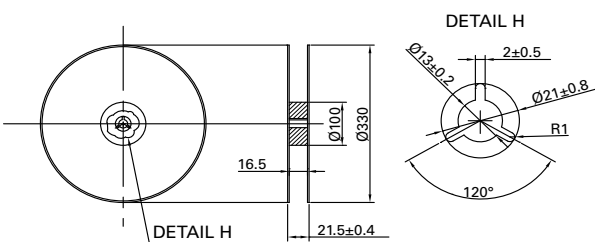

- NOTES:
- 1) All dimensions per EIA-481-c
  - 2) 10 pitches cumulative tolerance on tape ±0.20mm
  - 3) Quantity per 13 inch (330 mm) reel: 600 pcs