

PCB LAYOUT: COMPONENT SIDE  
RECOMMEND PCB THICKNESS: .062/1.57

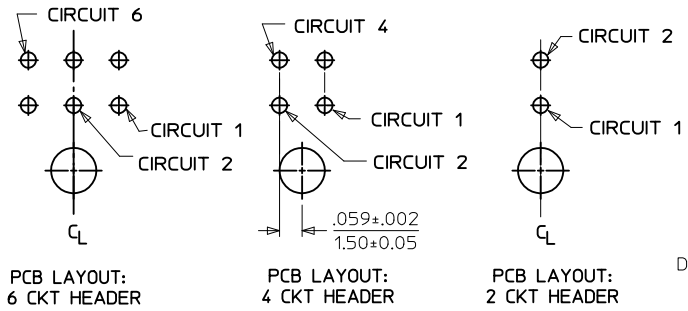

CKTS	A	B	C
02	.262 6.65	NA	NA
04	.380 9.65	.118 3.00	NA
06	.498 12.65	.236 6.00	NA
08	.616 15.65	.354 9.00	.185 4.70
10	.734 18.65	.472 12.00	.303 7.70
12	.852 21.65	.591 15.00	.421 10.70
14	.970 24.65	.709 18.00	.539 13.70
16	1.088 27.65	.827 21.00	.657 16.70
18	1.206 30.65	.945 24.00	.776 19.70
20	1.325 33.65	1.063 27.00	.894 22.70
22	1.443 36.65	1.181 30.00	1.012 25.70
24	1.561 39.65	1.299 33.00	1.130 28.70

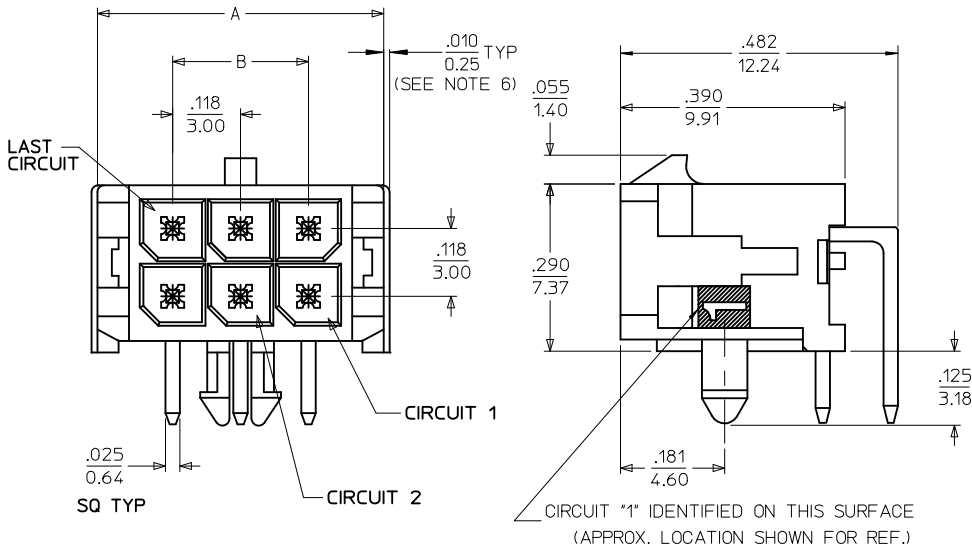

**25-07120**

**NOTES:**

- HOUSING MATERIAL: GLASS FILLED LIQUID CRYSTAL POLYMER, UL94V-0, COLOR: BLACK  
TERMINAL MATERIAL: BRASS ALLOY
- FINISH: A = .000100/(0.00254) MIN. TIN OVER  
.000050/(0.00127) MIN. NICKEL PLATE.  
B = .000015/(0.00038) MIN. SELECT GOLD IN CONTACT AREA,  
.000100/(0.00254) MIN. SELECT MATTE TIN ON SOLDER TAILS,  
BOTH OVER .000050/(0.00127) MIN. NICKEL PLATE.  
C = .000030/(0.00076) MIN. SELECT GOLD IN CONTACT AREA,  
.000100/(0.00254) MIN. SELECT MATTE TIN ON SOLDER TAILS,  
BOTH OVER .000050/(0.00127) MIN. NICKEL PLATE.
- PRODUCT SPECIFICATION: PS-43045
- TRAY PACKAGED : SEE MOLEX DRAWING PK-70873-0313
- MATES WITH MICRO FIT (3.0) RECEPTACLE SERIES 43025
- CIRCUIT SIZES 2-6: 'D' IS .265/6.74 FOR .010/0.25 STEP.  
CIRCUIT SIZES 8-24: 'D' IS .063/1.60 FOR .010/0.25 STEP.
- TO AVOID INTERFERENCE BETWEEN RECEPTACLE AND PCB, HEADER MUST BE PLACED WITHIN .400/(10.16) MAX. FROM EDGE OF PCB, AS SHOWN IN LOCATION DETAIL.
- THIS PART CONFORMS TO CLASS B REQUIREMENTS OF PRODUCT SPECIFICATION PS-45499-002.

CKTS	FINISH A	FINISH B	FINISH C
	MATERIAL NO:	MATERIAL NO:	MATERIAL NO:
02	43045-0200	43045-0201	43045-0202
04	43045-0400	43045-0401	43045-0402
06	43045-0600	43045-0601	43045-0602
08	43045-0800	43045-0801	43045-0802
10	43045-1000	43045-1001	43045-1002
12	43045-1200	43045-1201	43045-1202
14	43045-1400	43045-1401	43045-1402
16	43045-1600	43045-1601	43045-1602
18	43045-1800	43045-1801	43045-1802
20	43045-2000	43045-2001	43045-2002
22	43045-2200	43045-2201	43045-2202
24	43045-2400	43045-2401	43045-2402

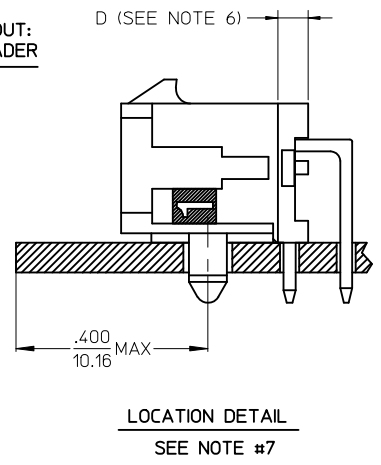

ADD 'D' DIM EC NO: UCP2011-0508 DRWNG: G. RAMANI 2010/08/24 CHKD: S. SOUSEK 2010/08/24 APPR: F. SMITH 2010/12/23	QUALITY SYMBOLS	GENERAL TOLERANCES (UNLESS SPECIFIED)	DIMENSION STYLE IN/MM	SCALE ---	DESIGN UNITS METRIC	THIRD ANGLE PROJECTION
	▽=0	4 PLACES ± --- ± ---	DRAWN BY SAMIEC	DATE 2000/03/15	MICRO-FIT (3.0) DUAL ROW RIGHT ANGLE THRU HOLE HEADER ASSY <b>MOLEX INCORPORATED</b> MOLEX INCORPORATED	
	▽=0	3 PLACES ± --- ± .010	CHECKED BY MUELLER	DATE 2000/03/15		
	▽=0	2 PLACES ± 0.25 ± .014	APPROVED BY EDGLEY	DATE 2000/03/15		
▽=0	1 PLACE ± 0.36 ± ---	MATERIAL NO. <b>SEE CHART</b>	DOCUMENT NO. SD-43045-001			
DRAFT WHERE APPLICABLE MUST REMAIN WITHIN DIMENSIONS		SIZE C		SHEET NO. 1 OF 1		
THIS DRAWING CONTAINS INFORMATION THAT IS PROPRIETARY TO MOLEX INCORPORATED AND SHOULD NOT BE USED WITHOUT WRITTEN PERMISSION						

20 19 18 17 16 15 14 13 12 11 9 8 7 6 5 4 3 2 1

43045

MICRO-FIT(3.0)  
DUAL-ROW SERIES

MICRO-FIT(3.0)  
IN-LINE SERIES

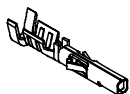

43030-xxxx  
FEMALE CRIMP TERMINAL

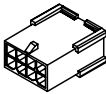

43020-xx01  
PLUG W/O MTG. EARS

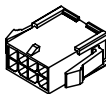

43020-xx00  
PLUG W/ MTG. EARS

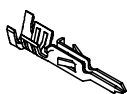

43031-xxxx  
MALE CRIMP TERMINAL

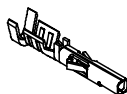

43030-xxxx  
FEMALE CRIMP TERMINAL

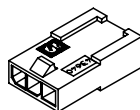

43640-xx01  
PLUG W/O MTG. EARS

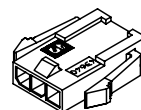

43640-xx00  
PLUG W/ MTG. EARS

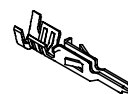

43031-xxxx  
MALE CRIMP TERMINAL

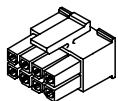

43025-xxxx  
RECEPTACLE

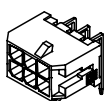

43045-xx00 THRU 43045-xx02  
RIGHT ANGLE THRU HOLE  
W/RETENTION PEG

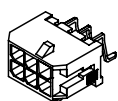

43045-xx03 THRU 43045-xx05  
RIGHT ANGLE SURFACE MOUNT  
W/RETENTION PEG

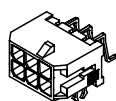

43045-xx06 THRU 43045-xx08  
RIGHT ANGLE SURFACE MOUNT  
W/RETENTION CLIP

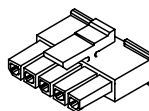

43645-xxxx  
RECEPTACLE

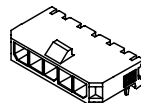

43650-xx00 THRU 43650-xx02  
RIGHT ANGLE THRU HOLE  
W/RETENTION PEG

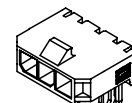

43650-xx03 THRU 43650-xx05  
RIGHT ANGLE THRU HOLE  
W/RETENTION CLIP

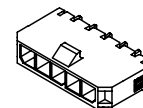

43650-xx06 THRU 43650-xx08  
RIGHT ANGLE SURFACE MOUNT  
W/RETENTION PEG

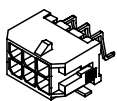

43045-xx09 THRU 43045-xx11  
RIGHT ANGLE SURFACE MOUNT  
W/FITTING NAIL

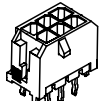

43045-xx12 THRU 43045-xx14  
VERTICAL O.T.R. THRU HOLE

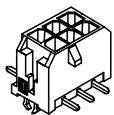

43045-xx15 THRU 43045-xx17  
VERTICAL SURFACE MOUNT  
W/RETENTION CLIP

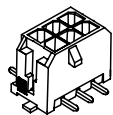

43045-xx18 THRU 43045-xx20  
VERTICAL SURFACE MOUNT  
W/FITTING NAIL

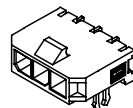

43650-xx09 THRU 43650-xx11  
RIGHT ANGLE SURFACE MOUNT  
W/RETENTION CLIP

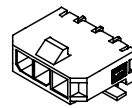

43650-xx12 THRU 43650-xx14  
RIGHT ANGLE SURFACE MOUNT  
W/FITTING NAIL

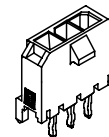

43650-xx15 THRU 43650-xx17  
VERTICAL O.T.R. THRU HOLE

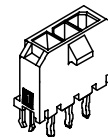

43650-xx18 THRU 43650-xx20  
VERTICAL O.T.R. THRU HOLE  
W/RETENTION CLIP

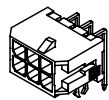

43045-xx21 THRU 43045-xx23  
RIGHT ANGLE THRU HOLE  
W/RETENTION CLIP

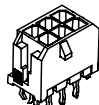

43045-xx24 THRU 43045-xx26  
VERTICAL O.T.R. THRU HOLE  
W/RETENTION CLIP

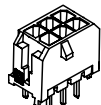

43045-xx27 THRU 43045-xx29  
VERTICAL STRAIGHT PIN THRU HOLE

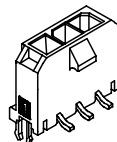

43650-xx21 THRU 43650-xx23  
VERTICAL SURFACE MOUNT  
W/RETENTION CLIP

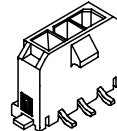

43650-xx24 THRU 43650-xx26  
VERTICAL SURFACE MOUNT  
W/FITTING NAIL

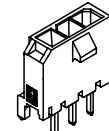

43650-xx27 THRU 43650-xx29  
VERTICAL STRAIGHT PIN THRU HOLE

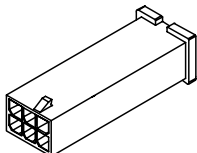

44242-0001 THRU 44242-0011  
4-24 CKT. TEST PLUG

REVISED/REDRAWN EC NO. UCP2004-1223 DRWN: ICERNY 2004/03/12 CHKD: CHKCD 2004/03/31 APPR: FSMITH 2004/04/05	QUALITY SYMBOLS	GENERAL TOLERANCES (UNLESS SPECIFIED)		SCALE	DESIGN UNITS	THIRD ANGLE PROJECTION	REVISE ON CAD ONLY	
	▽ 0 ▽ 0	4 PLACES ± 0.15 3 PLACES ± 0.20 2 PLACES ± 0.25 1 PLACE ± 0.30	mm INCH ± 0.15 ± 0.005 ± 0.20 ± 0.008 ± 0.25 ± 0.010 ± 0.30 ± 0.012	DIMENSION STYLE IN/MM	DATE 1999/03/11	DATE 1999/03/11	TITLE MICRO-FIT (3.0) CONNECTOR FAMILY (INDEX DRAWING)	
		DRAFT WHERE APPLICABLE		APPROVED BY	DATE	MATERIAL NO.	DOCUMENT NO.	
		MUST REMAIN WITHIN DIMENSIONS		EDGLEY	1999/03/11	SEE CHART	SDIN-43045-0001	SHEET NO. 1 OF 1

19 18 17 16 15 14 13 12 11 10 9 8 7 6 5 4 3 2 1