

25-07104

GH CONNECTOR

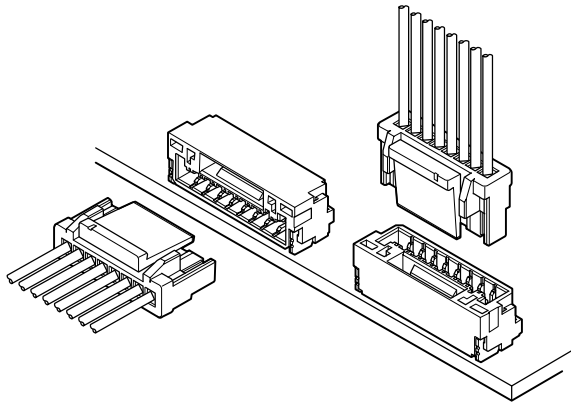

1.25mm pitch/Disconnectable Crimp style connectors



Developed for PDP, LCD or small electronics equipment. This low insertion force type connector realizes easier mating operation. The basic concept of the contact part of this connector is equivalent to the performance proven SHL connector.

- Secure locking structure
- Contact lock structure
- Prevention of contact deformation
- Clear engagement click sounds

Specifications

- Current rating: 1.0A AC, DC (AWG #26)
- Voltage rating: 50V AC, DC
- Temperature range: -25°C to +85°C
(including temperature rise in applying electrical current)
- Contact resistance: Initial value/ 30m Ω max.
After environmental testing/ 50m Ω max.
- Insulation resistance: 100M Ω min.
- Withstanding voltage: 500V AC/minute
- Applicable wire: Conductor size/ AWG #30 to #26
Insulation O.D./ 0.8 to 1.0mm

- * Compliant with RoHS.
- * Refer to "General Instruction and Notice when using Terminals and Connectors" at the end of this catalog.
- * Contact JST for details.

Standards

Recognized E60389

Top entry type

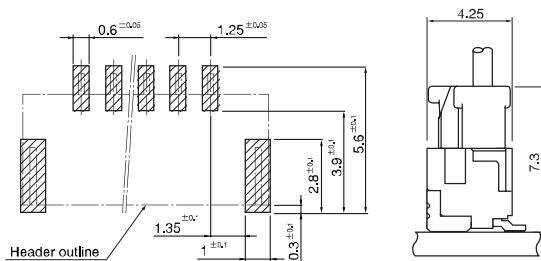

Side entry type

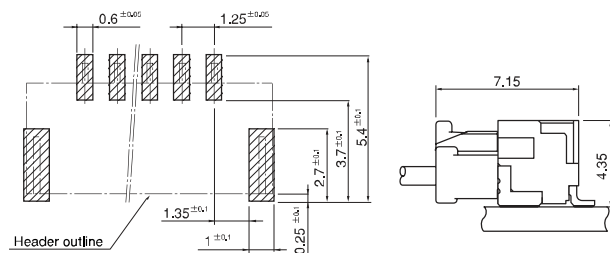

- Note: 1. The above figure is the figure viewed from the connector mounting side.
2. Tolerances are non-cumulative: ±0.05mm for all centers.
3. The dimensions above should serve as a guideline. Contact JST for details.

Contact

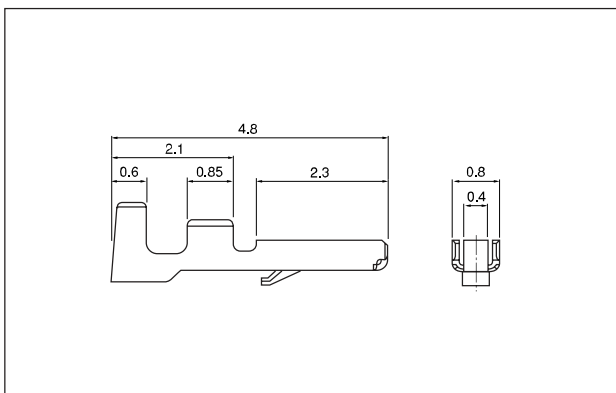

Model No.	Applicable wire		Insulation O.D. (mm)	Q'ty / reel
	mm ²	AWG#		
SSHL-002T-P0.2	0.05~0.13	30~26	0.8~1.0	23,000

Material and Finish

Phosphor bronze, tin-plated (reflow treatment)

RoHS compliance

- Note: 1. Contact JST for gold-plates products.
2. This contact can be applied only for GH connector.
SSHL-003()-P0.2 cannot be applied for GH connector.

Contact	Crimping machine	Applicator		
		Crimp applicator	Dies	Crimp applicator with dies
SSHL-002T-P0.2	AP-K2N	MKS-L-10-3	MK/SSHL-002-02	APLMK SSSL002-02
		-	-	-

Housing

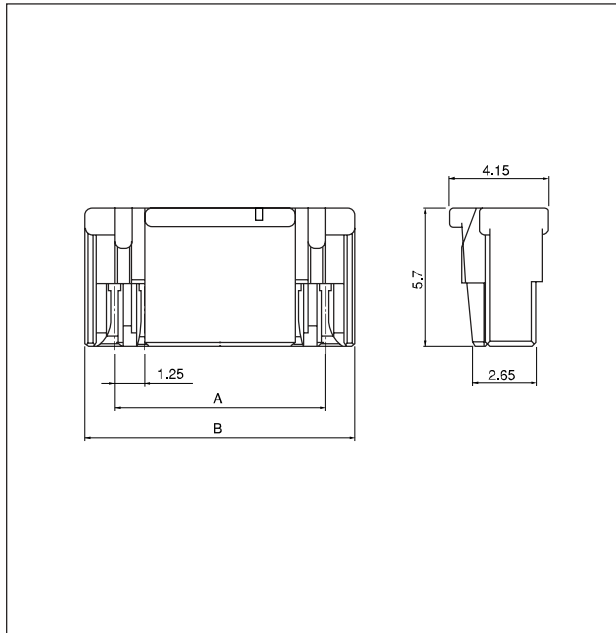

Circuits	Model No	Dimensions (mm)		Q'ty / bag
		A	B	
2	GHR-02V-S	1.25	3.75	3,000
3	GHR-03V-S	2.50	5.00	3,000
4	GHR-04V-S	3.75	6.25	3,000
5	GHR-05V-S	5.00	7.50	3,000
6	GHR-06V-S	6.25	8.75	3,000
7	GHR-07V-S	7.50	10.00	3,000
8	GHR-08V-S	8.75	11.25	3,000
9	GHR-09V-S	10.00	12.50	3,000
10	GHR-10V-S	11.25	13.75	3,000
11	GHR-11V-S	12.50	15.00	3,000
12	GHR-12V-S	13.75	16.25	3,000
13	GHR-13V-S	15.00	17.50	3,000
14	GHR-14V-S	16.25	18.75	3,000
15	GHR-15V-S	17.50	20.00	3,000

Material

PBT, UL94V-0, natural (white)

RoHS compliance

<For reference> As the color identification, the following alphabet shall be put in the underlined part. For availability, delivery and minimum order quantity, contact JST.

ex. **GHR-04V-S**

S...natural LE...light blue TR...tomato red K...black E...blue
O...orange L...lemon yellow MG...moss green

Shrouded header

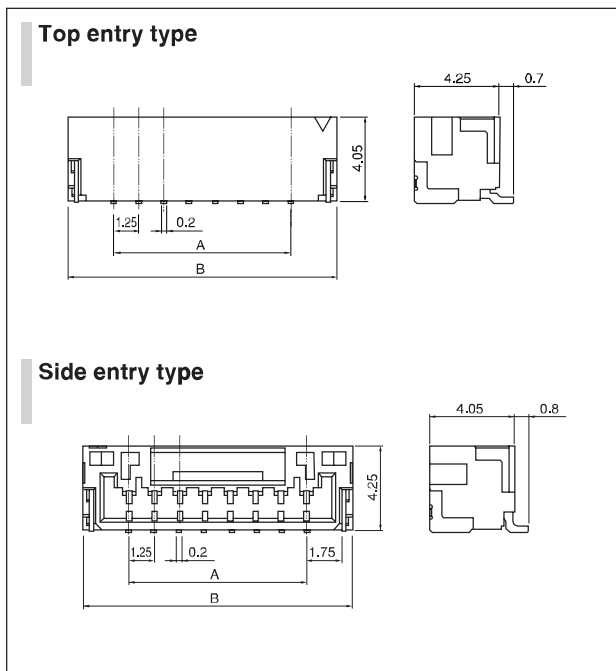

Circuits	Model No.		Dimensions (mm)		Q'ty / reel
	Top entry type	Side entry type	A	B	
2	BM02B-GHS-TBT	SM02B-GHS-TB	1.25	5.75	2,500
3	BM03B-GHS-TBT	SM03B-GHS-TB	2.50	7.00	2,500
4	BM04B-GHS-TBT	SM04B-GHS-TB	3.75	8.25	2,500
5	BM05B-GHS-TBT	SM05B-GHS-TB	5.00	9.50	2,500
6	BM06B-GHS-TBT	SM06B-GHS-TB	6.25	10.75	2,500
7	BM07B-GHS-TBT	SM07B-GHS-TB	7.50	12.00	2,500
8	BM08B-GHS-TBT	SM08B-GHS-TB	8.75	13.25	2,500
9	BM09B-GHS-TBT	SM09B-GHS-TB	10.00	14.50	2,500
10	BM10B-GHS-TBT	SM10B-GHS-TB	11.25	15.75	2,500
11	BM11B-GHS-TBT	SM11B-GHS-TB	12.50	17.00	2,500
12	BM12B-GHS-TBT	SM12B-GHS-TB	13.75	18.25	2,500
13	BM13B-GHS-TBT	SM13B-GHS-TB	15.00	19.50	2,500
14	BM14B-GHS-TBT	SM14B-GHS-TB	16.25	20.75	2,500
15	BM15B-GHS-TBT	SM15B-GHS-TB	17.50	22.00	2,500

Material and Finish

Contact: Phosphor bronze, copper-undercoated, tin-plated (reflow treatment)
Housing: PA9T, UL94V-0, natural (ivory)
Solder tab: Brass, copper-undercoated, tin-plated

RoHS compliance This product displays (LF)(SN) on a label.
Note: Contact JST for gold-plated products.

<For reference> As the color identification, the following alphabet shall be put in the underlined part. For availability, delivery and minimum order quantity, contact JST.

ex. **BM04B-GHS-TBT**

S...natural (ivory) LE...light blue TR...tomato red K...black
E...blue O...orange L...lemon yellow MG...moss green