

DS90LV027A LVDS Dual High Speed Differential Driver

Check for Samples: [DS90LV027A](#)

FEATURES

- >600 Mbps (300MHz) switching rates
- 0.3 ns typical differential skew
- 0.7 ns maximum differential skew
- 1.5 ns maximum propagation delay
- 3.3V power supply design
- ±360 mV differential signaling
- Low power dissipation (46 mW @ 3.3V static)
- Flow-through design simplifies PCB layout
- Interoperable with existing 5V LVDS devices
- Power Off Protection (outputs in high impedance)
- Conforms to TIA/EIA-644 Standard
- 8-Lead SOIC package saves space
- Industrial temperature operating range
 - (–40°C to +85°C)

DESCRIPTION

The DS90LV027A is a dual LVDS driver device optimized for high data rate and low power applications. The device is designed to support data rates in excess of 600Mbps (300MHz) utilizing Low Voltage Differential Signaling (LVDS) technology. The DS90LV027A is a current mode driver allowing power dissipation to remain low even at high frequency. In addition, the short circuit fault current is also minimized.

The device is in a 8-lead SOIC package. The DS90LV027A has a flow-through design for easy PCB layout. The differential driver outputs provides low EMI with its typical low output swing of 360 mV. It is perfect for high speed transfer of clock and data. The DS90LV027A can be paired with its companion dual line receiver, the DS90LV028A, or with any of National's LVDS receivers, to provide a high-speed point-to-point LVDS interface.

Connection Diagram

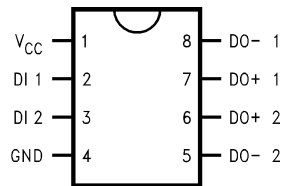
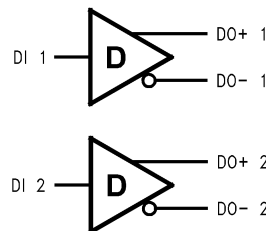

Figure 1. Dual-In-Line
See Package Number D (R-PDSO-G8)

Functional Diagram



These devices have limited built-in ESD protection. The leads should be shorted together or the device placed in conductive foam during storage or handling to prevent electrostatic damage to the MOS gates.



Please be aware that an important notice concerning availability, standard warranty, and use in critical applications of Texas Instruments semiconductor products and disclaimers thereto appears at the end of this data sheet.

All trademarks are the property of their respective owners.

Absolute Maximum Ratings ⁽¹⁾

Supply Voltage (V_{CC})	-0.3V to +4V
Input Voltage (DI)	-0.3V to +3.6V
Output Voltage (DO \pm)	-0.3V to +3.9V
Maximum Package Power Dissipation @ +25°C	
D Package	1190 mW
Derate D Package	9.5 mW/°C above +25°C
Storage Temperature Range	-65°C to +150°C
Lead Temperature Range Soldering	
(4 sec.)	+260°C
ESD Ratings	
(HBM 1.5 k Ω , 100 pF)	\geq 8kV
(EIAJ 0 Ω , 200 pF)	\geq 1000V
(CDM)	\geq 1000V
(IEC direct 330 Ω , 150 pF)	\geq 4kV

(1) "Absolute Maximum Ratings" are those values beyond which the safety of the device cannot be guaranteed. They are not meant to imply that the devices should be operated at these limits. [Electrical Characteristics](#) specifies conditions of device operation.

Recommended Operating Conditions

	Min	Typ	Max	Units
Supply Voltage (V_{CC})	3.0	3.3	3.6	V
Temperature (T_A)	-40	25	+85	°C

Electrical Characteristics

Over Supply Voltage and Operating Temperature ranges, unless otherwise specified. ⁽¹⁾ ⁽²⁾ ⁽³⁾

Symbol	Parameter	Conditions	Pin	Min	Typ	Max	Units	
DIFFERENTIAL DRIVER CHARACTERISTICS								
V_{OD}	Output Differential Voltage	$R_L = 100\Omega$ (Figure 2)	DO+, DO-	250	360	450	mV	
ΔV_{OD}	V_{OD} Magnitude Change				1	35	mV	
V_{OH}	Output High Voltage				1.4	1.6	V	
V_{OL}	Output Low Voltage				0.9	1.1	V	
V_{OS}	Offset Voltage				1.125	1.2	1.375	V
ΔV_{OS}	Offset Magnitude Change				0	3	25	mV
I_{OXD}	Power-off Leakage			$V_{OUT} = V_{CC}$ or GND, $V_{CC} = 0V$		± 1	± 10	μA
I_{OSD}	Output Short Circuit Current			-5.7	-8	mA		
V_{IH}	Input High Voltage		DI	2.0		V_{CC}	V	
V_{IL}	Input Low Voltage			GND		0.8	V	
I_{IH}	Input High Current	$V_{IN} = 3.3V$ or 2.4V			± 2	± 10	μA	
I_{IL}	Input Low Current	$V_{IN} = GND$ or 0.5V			± 1	± 10	μA	
V_{CL}	Input Clamp Voltage	$I_{CL} = -18$ mA		-1.5	-0.6		V	
I_{CC}	Power Supply Current	No Load	$V_{IN} = V_{CC}$ or GND	V_{CC}	8	14	mA	
		$R_L = 100\Omega$			14	20	mA	

- (1) Current into device pins is defined as positive. Current out of device pins is defined as negative. All voltages are referenced to ground except V_{OD} .
- (2) All typicals are given for: $V_{CC} = +3.3V$ and $T_A = +25^\circ C$.
- (3) The DS90LV027A is a current mode device and only function with datasheet specification when a resistive load is applied to the drivers outputs.

Switching Characteristics

Over Supply Voltage and Operating Temperature Ranges, unless otherwise specified. ⁽¹⁾ ⁽²⁾ ⁽³⁾ ⁽⁴⁾

Symbol	Parameter	Conditions	Min	Typ	Max	Units
DIFFERENTIAL DRIVER CHARACTERISTICS						
t_{PHLD}	Differential Propagation Delay High to Low	$R_L = 100\Omega$, $C_L = 15\text{ pF}$ (Figure 3 and Figure 4)	0.3	0.8	1.5	ns
t_{PLHD}	Differential Propagation Delay Low to High		0.3	1.1	1.5	ns
t_{SKD1}	Differential Pulse Skew $ t_{PHLD} - t_{PLHD} $ ⁽⁵⁾		0	0.3	0.7	ns
t_{SKD2}	Channel to Channel Skew ⁽⁶⁾		0	0.4	0.8	ns
t_{SKD3}	Differential Part to Part Skew ⁽⁷⁾		0		1.0	ns
t_{SKD4}	Differential Part to Part Skew ⁽⁸⁾		0		1.2	ns
t_{TLH}	Transition Low to High Time		0.2	0.5	1.0	ns
t_{THL}	Transition High to Low Time		0.2	0.5	1.0	ns
f_{MAX}	Maximum Operating Frequency ⁽⁹⁾				350	MHz

- (1) All typicals are given for: $V_{CC} = +3.3V$ and $T_A = +25^\circ C$.
- (2) These parameters are guaranteed by design. The limits are based on statistical analysis of the device over PVT (process, voltage, temperature) ranges.
- (3) C_L includes probe and fixture capacitance.
- (4) Generator waveform for all tests unless otherwise specified: $f = 1\text{ MHz}$, $Z_O = 50\Omega$, $t_r \leq 1\text{ ns}$, $t_f \leq 1\text{ ns}$ (10%-90%).
- (5) t_{SKD1} , $|t_{PHLD} - t_{PLHD}|$, is the magnitude difference in differential propagation delay time between the positive going edge and the negative going edge of the same channel.
- (6) t_{SKD2} is the Differential Channel to Channel Skew of any event on the same device.
- (7) t_{SKD3} , Differential Part to Part Skew, is defined as the difference between the minimum and maximum specified differential propagation delays. This specification applies to devices at the same V_{CC} and within $5^\circ C$ of each other within the operating temperature range.
- (8) t_{SKD4} , part to part skew, is the differential channel to channel skew of any event between devices. This specification applies to devices over recommended operating temperature and voltage ranges, and across process distribution. t_{SKD4} is defined as $|Max - Min|$ differential propagation delay.
- (9) f_{MAX} generator input conditions: $t_r = t_f < 1\text{ ns}$ (0% to 100%), 50% duty cycle, 0V to 3V. Output criteria: duty cycle = 45%/55%, $V_{OD} > 250mV$, all channels switching.

PARAMETER MEASUREMENT INFORMATION

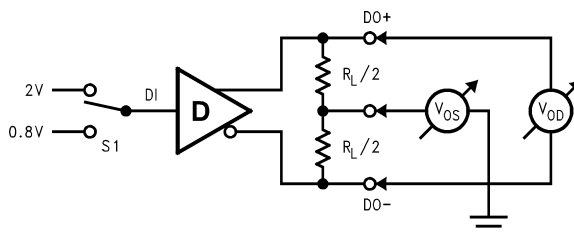

Figure 2. Differential Driver DC Test Circuit

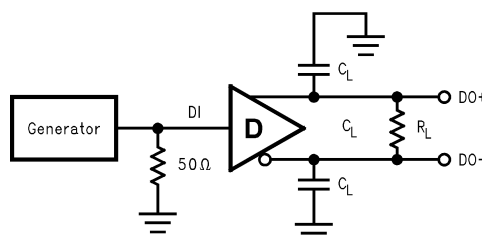

Figure 3. Differential Driver Propagation Delay and Transition Time Test Circuit

PARAMETER MEASUREMENT INFORMATION (continued)

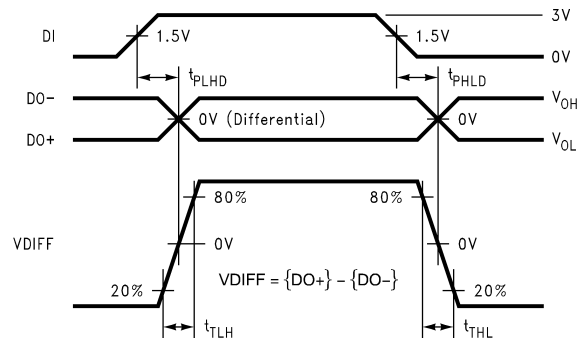

Figure 4. Differential Driver Propagation Delay and Transition Time Waveforms

APPLICATION INFORMATION

Table 1. Device Pin Descriptions

Pin #	Name	Description
2, 3	DI	TTL/CMOS driver input pins
6, 7	DO+	Non-inverting driver output pin
5, 8	DO-	Inverting driver output pin
4	GND	Ground pin
1	V _{CC}	Positive power supply pin, +3.3V ± 0.3V

Typical Performance Curves

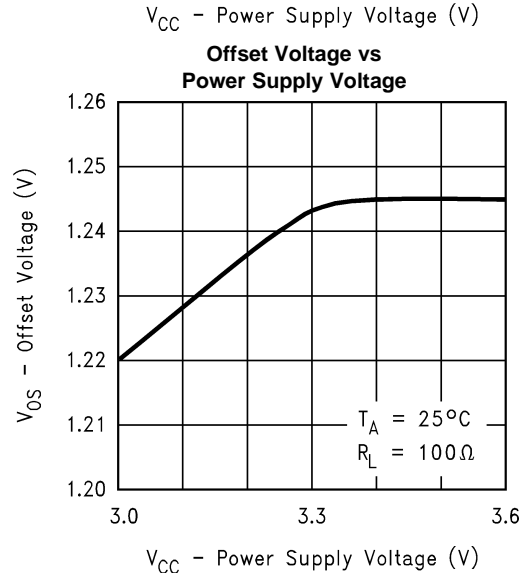
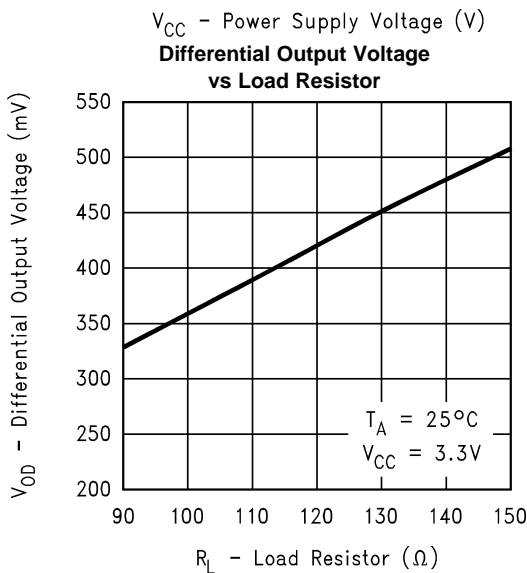
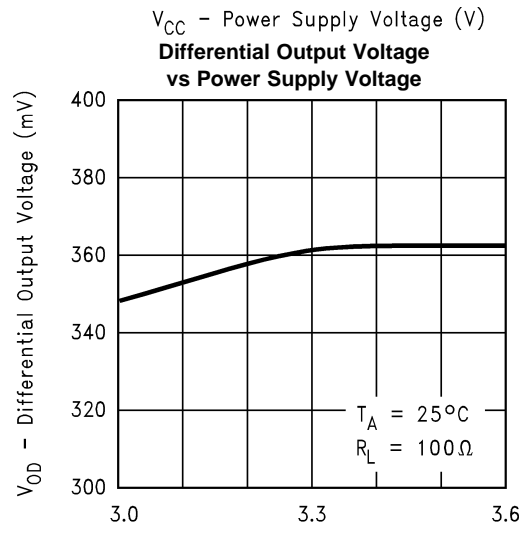
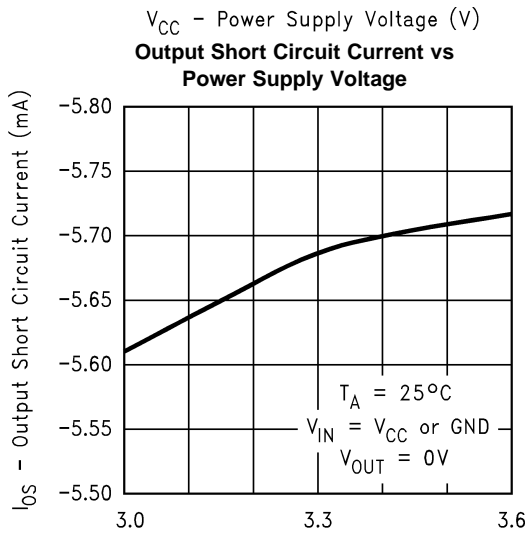
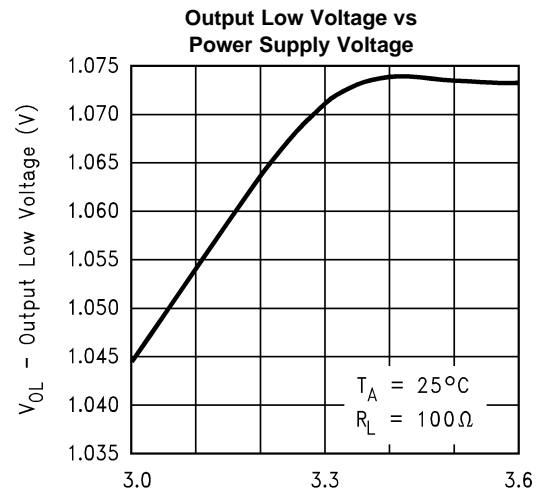
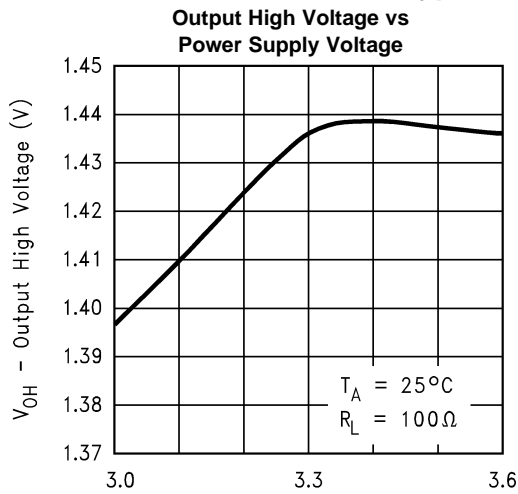

Typical Performance Curves (continued)

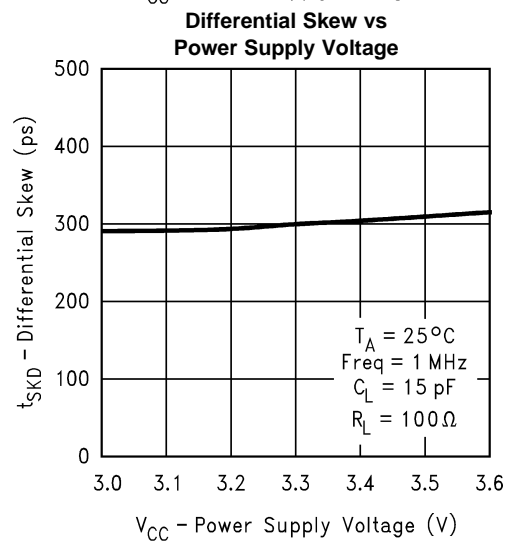
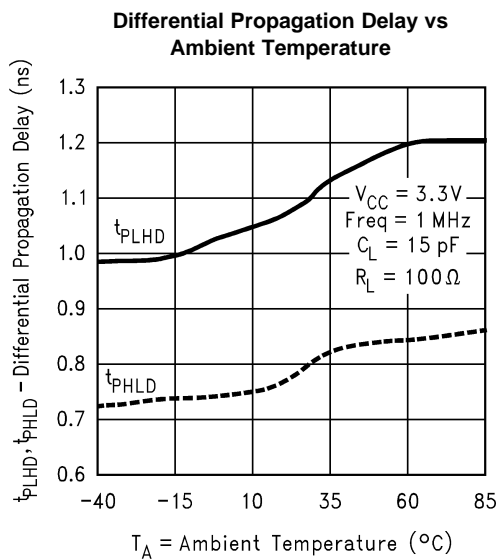
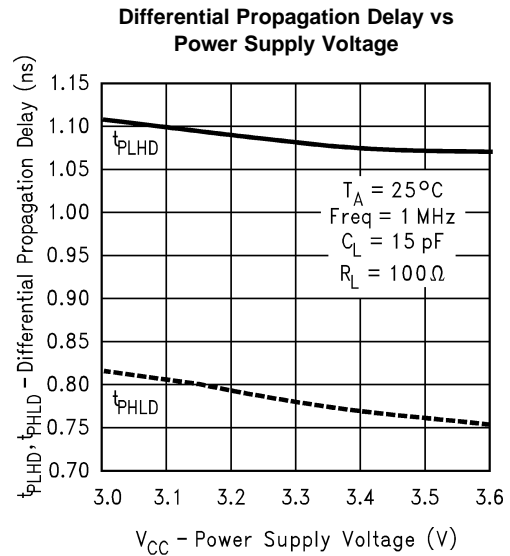
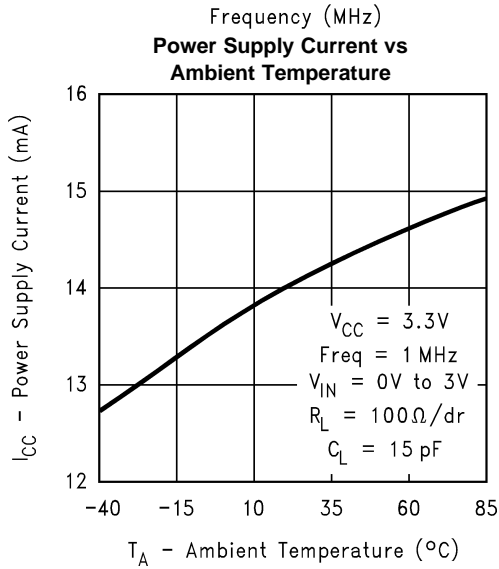
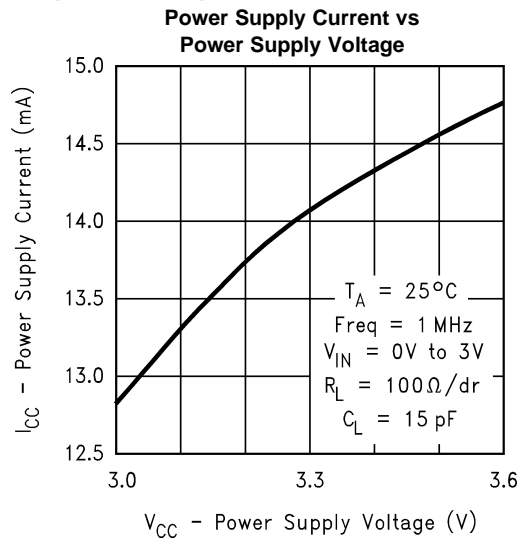
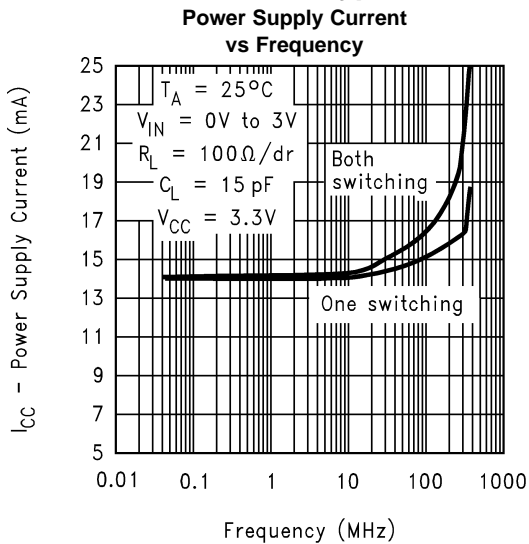

Typical Performance Curves (continued)

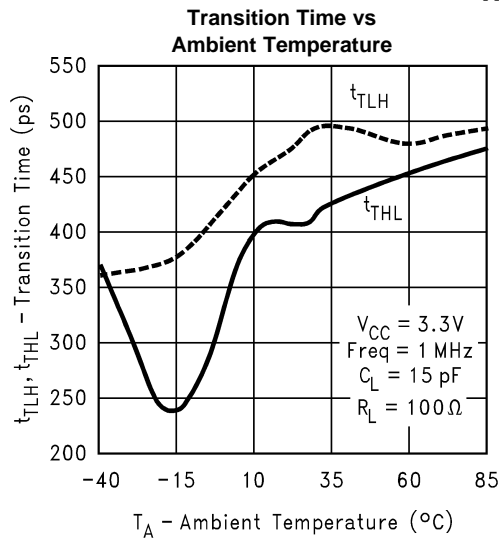
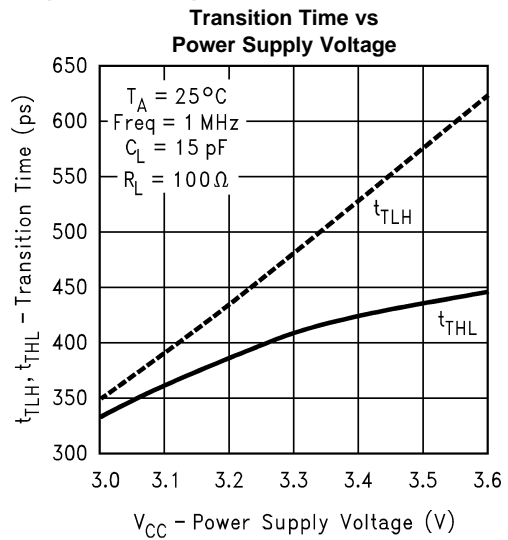
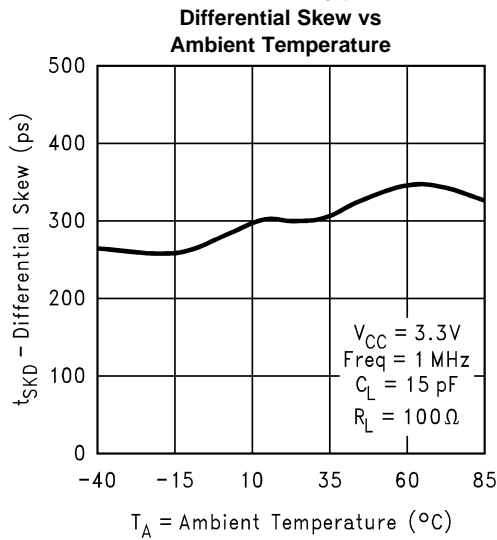

PACKAGING INFORMATION

Orderable Device	Status (1)	Package Type	Package Drawing	Pins	Package Qty	Eco Plan (2)	Lead/Ball Finish	MSL Peak Temp (3)	Op Temp (°C)	Top-Side Markings (4)	Samples
DS90LV027ATM	ACTIVE	SOIC	D	8	95	TBD	CU SNPB	Level-1-235C-UNLIM	-40 to 85	LV27A TM	Samples
DS90LV027ATM/NOPB	ACTIVE	SOIC	D	8	95	Green (RoHS & no Sb/Br)	CU SN	Level-1-260C-UNLIM	-40 to 85	LV27A TM	Samples
DS90LV027ATMX	ACTIVE	SOIC	D	8	2500	TBD	CU SNPB	Level-1-235C-UNLIM	-40 to 85	LV27A TM	Samples
DS90LV027ATMX/NOPB	ACTIVE	SOIC	D	8	2500	Green (RoHS & no Sb/Br)	CU SN	Level-1-260C-UNLIM	-40 to 85	LV27A TM	Samples

(1) The marketing status values are defined as follows:

ACTIVE: Product device recommended for new designs.

LIFEBUY: TI has announced that the device will be discontinued, and a lifetime-buy period is in effect.

NRND: Not recommended for new designs. Device is in production to support existing customers, but TI does not recommend using this part in a new design.

PREVIEW: Device has been announced but is not in production. Samples may or may not be available.

OBSOLETE: TI has discontinued the production of the device.

(2) Eco Plan - The planned eco-friendly classification: Pb-Free (RoHS), Pb-Free (RoHS Exempt), or Green (RoHS & no Sb/Br) - please check <http://www.ti.com/productcontent> for the latest availability information and additional product content details.

TBD: The Pb-Free/Green conversion plan has not been defined.

Pb-Free (RoHS): TI's terms "Lead-Free" or "Pb-Free" mean semiconductor products that are compatible with the current RoHS requirements for all 6 substances, including the requirement that lead not exceed 0.1% by weight in homogeneous materials. Where designed to be soldered at high temperatures, TI Pb-Free products are suitable for use in specified lead-free processes.

Pb-Free (RoHS Exempt): This component has a RoHS exemption for either 1) lead-based flip-chip solder bumps used between the die and package, or 2) lead-based die adhesive used between the die and leadframe. The component is otherwise considered Pb-Free (RoHS compatible) as defined above.

Green (RoHS & no Sb/Br): TI defines "Green" to mean Pb-Free (RoHS compatible), and free of Bromine (Br) and Antimony (Sb) based flame retardants (Br or Sb do not exceed 0.1% by weight in homogeneous material)

(3) MSL, Peak Temp. -- The Moisture Sensitivity Level rating according to the JEDEC industry standard classifications, and peak solder temperature.

(4) Only one of markings shown within the brackets will appear on the physical device.

Important Information and Disclaimer: The information provided on this page represents TI's knowledge and belief as of the date that it is provided. TI bases its knowledge and belief on information provided by third parties, and makes no representation or warranty as to the accuracy of such information. Efforts are underway to better integrate information from third parties. TI has taken and continues to take reasonable steps to provide representative and accurate information but may not have conducted destructive testing or chemical analysis on incoming materials and chemicals. TI and TI suppliers consider certain information to be proprietary, and thus CAS numbers and other limited information may not be available for release.

In no event shall TI's liability arising out of such information exceed the total purchase price of the TI part(s) at issue in this document sold by TI to Customer on an annual basis.

TAPE AND REEL INFORMATION



QUADRANT ASSIGNMENTS FOR PIN 1 ORIENTATION IN TAPE



*All dimensions are nominal

Device	Package Type	Package Drawing	Pins	SPQ	Reel Diameter (mm)	Reel Width W1 (mm)	A0 (mm)	B0 (mm)	K0 (mm)	P1 (mm)	W (mm)	Pin1 Quadrant
DS90LV027ATMX	SOIC	D	8	2500	330.0	12.4	6.5	5.4	2.0	8.0	12.0	Q1
DS90LV027ATMX/NOPB	SOIC	D	8	2500	330.0	12.4	6.5	5.4	2.0	8.0	12.0	Q1

TAPE AND REEL BOX DIMENSIONS

*All dimensions are nominal

Device	Package Type	Package Drawing	Pins	SPQ	Length (mm)	Width (mm)	Height (mm)
DS90LV027ATMX	SOIC	D	8	2500	349.0	337.0	45.0
DS90LV027ATMX/NOPB	SOIC	D	8	2500	349.0	337.0	45.0

D (R-PDSO-G8)

PLASTIC SMALL OUTLINE

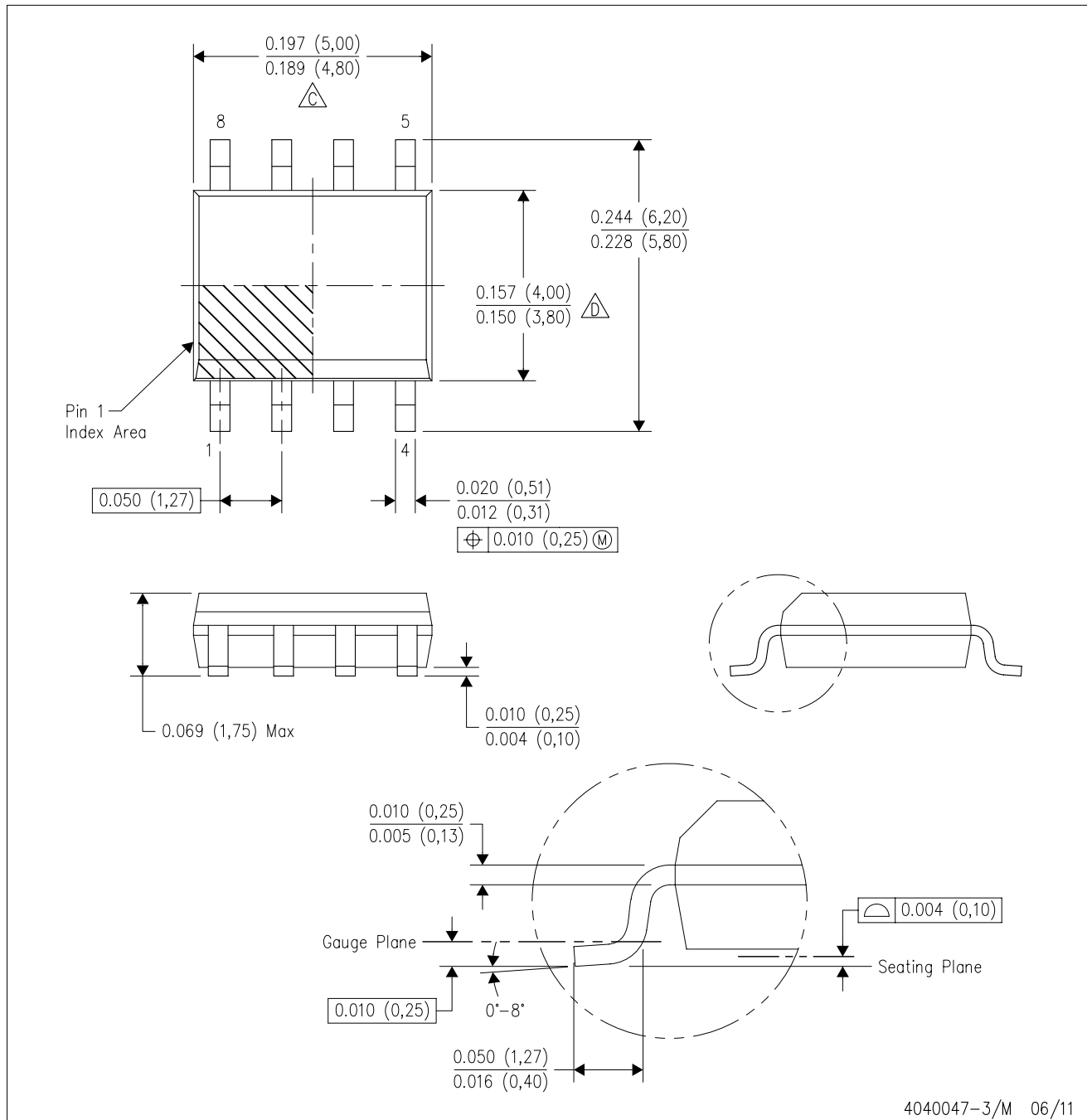

- NOTES:
- A. All linear dimensions are in inches (millimeters).
 - B. This drawing is subject to change without notice.
 - Body length does not include mold flash, protrusions, or gate burrs. Mold flash, protrusions, or gate burrs shall not exceed 0.006 (0,15) each side.
 - Body width does not include interlead flash. Interlead flash shall not exceed 0.017 (0,43) each side.
 - E. Reference JEDEC MS-012 variation AA.

IMPORTANT NOTICE

Texas Instruments Incorporated and its subsidiaries (TI) reserve the right to make corrections, enhancements, improvements and other changes to its semiconductor products and services per JESD46, latest issue, and to discontinue any product or service per JESD48, latest issue. Buyers should obtain the latest relevant information before placing orders and should verify that such information is current and complete. All semiconductor products (also referred to herein as "components") are sold subject to TI's terms and conditions of sale supplied at the time of order acknowledgment.

TI warrants performance of its components to the specifications applicable at the time of sale, in accordance with the warranty in TI's terms and conditions of sale of semiconductor products. Testing and other quality control techniques are used to the extent TI deems necessary to support this warranty. Except where mandated by applicable law, testing of all parameters of each component is not necessarily performed.

TI assumes no liability for applications assistance or the design of Buyers' products. Buyers are responsible for their products and applications using TI components. To minimize the risks associated with Buyers' products and applications, Buyers should provide adequate design and operating safeguards.

TI does not warrant or represent that any license, either express or implied, is granted under any patent right, copyright, mask work right, or other intellectual property right relating to any combination, machine, or process in which TI components or services are used. Information published by TI regarding third-party products or services does not constitute a license to use such products or services or a warranty or endorsement thereof. Use of such information may require a license from a third party under the patents or other intellectual property of the third party, or a license from TI under the patents or other intellectual property of TI.

Reproduction of significant portions of TI information in TI data books or data sheets is permissible only if reproduction is without alteration and is accompanied by all associated warranties, conditions, limitations, and notices. TI is not responsible or liable for such altered documentation. Information of third parties may be subject to additional restrictions.

Resale of TI components or services with statements different from or beyond the parameters stated by TI for that component or service voids all express and any implied warranties for the associated TI component or service and is an unfair and deceptive business practice. TI is not responsible or liable for any such statements.

Buyer acknowledges and agrees that it is solely responsible for compliance with all legal, regulatory and safety-related requirements concerning its products, and any use of TI components in its applications, notwithstanding any applications-related information or support that may be provided by TI. Buyer represents and agrees that it has all the necessary expertise to create and implement safeguards which anticipate dangerous consequences of failures, monitor failures and their consequences, lessen the likelihood of failures that might cause harm and take appropriate remedial actions. Buyer will fully indemnify TI and its representatives against any damages arising out of the use of any TI components in safety-critical applications.

In some cases, TI components may be promoted specifically to facilitate safety-related applications. With such components, TI's goal is to help enable customers to design and create their own end-product solutions that meet applicable functional safety standards and requirements. Nonetheless, such components are subject to these terms.

No TI components are authorized for use in FDA Class III (or similar life-critical medical equipment) unless authorized officers of the parties have executed a special agreement specifically governing such use.

Only those TI components which TI has specifically designated as military grade or "enhanced plastic" are designed and intended for use in military/aerospace applications or environments. Buyer acknowledges and agrees that any military or aerospace use of TI components which have **not** been so designated is solely at the Buyer's risk, and that Buyer is solely responsible for compliance with all legal and regulatory requirements in connection with such use.

TI has specifically designated certain components as meeting ISO/TS16949 requirements, mainly for automotive use. In any case of use of non-designated products, TI will not be responsible for any failure to meet ISO/TS16949.

Products

Audio	www.ti.com/audio
Amplifiers	amplifier.ti.com
Data Converters	dataconverter.ti.com
DLP® Products	www.dlp.com
DSP	dsp.ti.com
Clocks and Timers	www.ti.com/clocks
Interface	interface.ti.com
Logic	logic.ti.com
Power Mgmt	power.ti.com
Microcontrollers	microcontroller.ti.com
RFID	www.ti-rfid.com
OMAP Applications Processors	www.ti.com/omap
Wireless Connectivity	www.ti.com/wirelessconnectivity

Applications

Automotive and Transportation	www.ti.com/automotive
Communications and Telecom	www.ti.com/communications
Computers and Peripherals	www.ti.com/computers
Consumer Electronics	www.ti.com/consumer-apps
Energy and Lighting	www.ti.com/energy
Industrial	www.ti.com/industrial
Medical	www.ti.com/medical
Security	www.ti.com/security
Space, Avionics and Defense	www.ti.com/space-avionics-defense
Video and Imaging	www.ti.com/video

TI E2E Community

e2e.ti.com