

PA FAMILY SERIES/PA•PAF•PAL CONNECTOR

25-06288

2.0mm pitch/Wire-to-board (Crimp style/IDC) / Wire-to-wire (Crimp style/IDC)

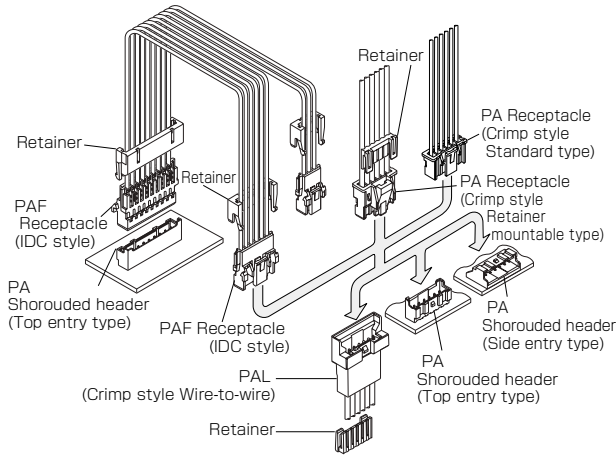

Based upon wire-to-board crimp style PA connectors, the PA series family of connector have been expanded to meet the requirement of complex wire harness of 2.0mm pitch connectors with secure locking mechanism thanks to the additional line up of wire-to-board IDC style PAF connectors and wire-to-wire crimp style PAL connectors.

- Secure locking device
- Interchangeable between crimp and IDC socket
- Secondary retainers
- Harness variation

PA connector (Standard type, Retainer mountable type)

- Highly reliable contact
- Insertion guide mechanism
- Flanged press pin

PAF connector

- The industry's first secure lock ID connectors
- Metallic strain relief
- Retainer with four locking points

PAL connector

- The industry's first wire to wire 2.0mm pitch retainer mountable type connector.
- Either with or without panel lock can be selected according to application.

Standards

- Recognized E60389
- Certified LR20812

Specifications

PA Connector (Standard type)

- Current rating: 3A AC, DC (AWG #22)
- Voltage rating: 250V AC, DC
- Temperature range: -25°C to +85°C
(including temperature rise in applying electrical current)
- Contact resistance: Initial value/ 10m Ω max.
After environmental testing/ 20m Ω max.
- Insulation resistance: Initial/ 1,000M Ω min.
- Withstanding voltage: 800V AC/minute
- Applicable wire: AWG #28 to #22
- Applicable PC board thickness: 1.6mm

PA Connector (Retainer mountable type)

- Current rating: 3A AC, DC (AWG #22)
- Voltage rating: 100V AC, DC
- Temperature range: -25°C to +85°C
(including temperature rise in applying electrical current)
- Contact resistance: Initial value/ 15m Ω max.
After environmental testing/ 25m Ω max.
- Insulation resistance: Initial/ 1,000M Ω min.
- Withstanding voltage: 800V AC/minute
- Applicable wire: AWG #28 to #22

PAF Connector

- Current rating: 1.0A AC, DC (AWG #26)
- Voltage rating: 100V AC, DC
- Temperature range: -25°C to +85°C
(including temperature rise in applying electrical current)
- Contact resistance: Initial value/ 15m Ω max.
After environmental testing/ 25m Ω max.
- Insulation resistance: Initial/ 1,000M Ω min.
- Withstanding voltage: 800V AC/minute
- Applicable wire: UL1061(Contact JST for details regarding other UL wires.)
AWG #26
Conductor/ 7 strands, tin-coated annealed copper
Insulation O.D./ 0.9 to 1.0mm

PAL Connector

- Current rating: 3A AC, DC (AWG #22)
- Voltage rating: 100V AC, DC
- Temperature range: -25°C to +85°C
(including temperature rise in applying electrical current)
- Contact resistance: Initial value/ 15m Ω max.
After environmental testing/ 25m Ω max.
- Insulation resistance: Initial/ 1,000M Ω min.
- Withstanding voltage: 800V AC/minute
- Applicable wire: AWG #28 to #22
- Applicable panel thickness : 0.5 to 2.0mm

- * Compliant with RoHS.
- * Refer to "General Instruction and Notice when using Terminals and Connectors" at the end of this catalog.
- * Contact JST for details.

PA FAMILY SERIES /PA•PAF•PAL CONNECTOR

List of combinations

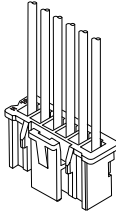
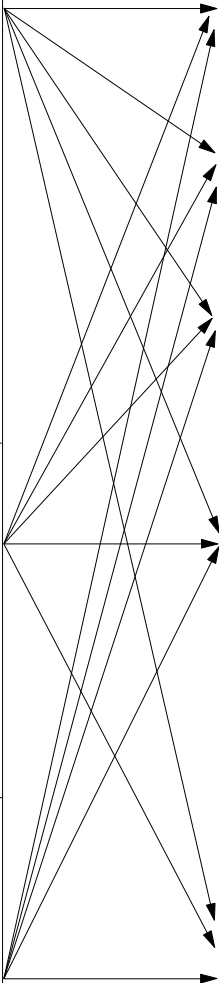
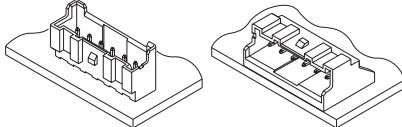
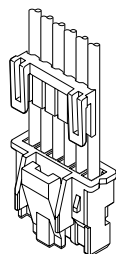
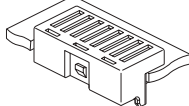
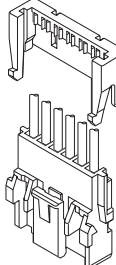
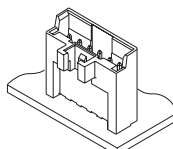
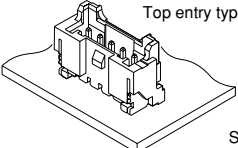
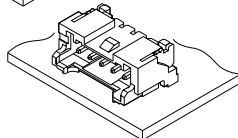
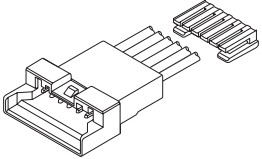
<p>Crimp style Standard type</p> 	<p><u>Contact</u> SPHD-001T-P0.5 SPHD-002T-P0.5</p> <p><u>Housing</u> PAP-()V-S</p>		<p><u>Shrouded header</u> B()B-PASK B()B-PASK-1 S()B-PASK-2</p>	<p>Top entry type Side entry type</p> 
<p>Crimp style Retainer mountable type</p> 	<p><u>Contact</u> SPA-001T-P0.5</p> <p><u>Housing</u> PARP-()V</p> <p><u>Retainer</u> PMS-()V-S</p>		<p><u>Shrouded header</u> BE()B-PASK</p>	<p>Bottom type</p> 
<p>Insulation displacement type</p> 	<p><u>Receptacle</u> ()PAF-6S</p> <p><u>Retainer</u> PAFS-()V-S</p>		<p><u>Shrouded header</u> BH()B-PASK BH()B-PASK-1</p>	<p>High box type</p> 
			<p><u>Shrouded header</u> BM()B-PASS BM()B-PASS-1 SM()B-PASS SM()B-PASS-1</p>	<p>SMT type</p> <p>Top entry type</p>  <p>Side entry type</p> 
			<p><u>Contact</u> SPAL-001T-P0.5 SPAL-002T-P0.5</p> <p><u>Receptacle housing</u> PALR-()V(F)</p> <p><u>Retainer</u> PMS-()V-S</p>	<p>Wire to wire Connectors</p> 

PA FAMILY SERIES /PA•PAF•PAL CONNECTOR

Through-hole type Top entry type

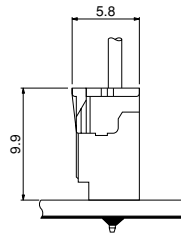
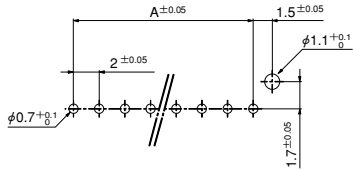

PA Receptacle
(Standard type)
+
PA Header

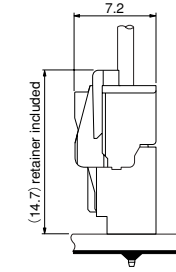

PA Receptacle
(Retainer mountable type)
+
PA Header

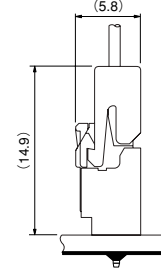

PAF Receptacle
+
PA Header

Side entry type

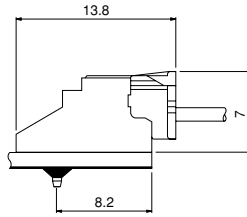
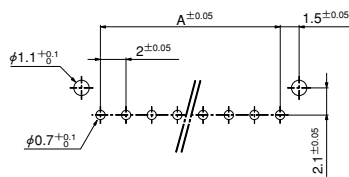

PA Receptacle
(Standard type)
+
PA side entry type header

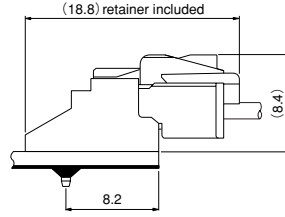

PA Receptacle
(Retainer mountable type)
+
PA side entry type header

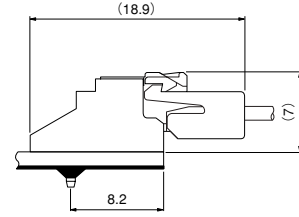

PAF Receptacle
+
PA side entry type header

Bottom type

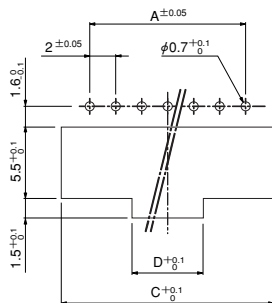

Note: C and D dimensions; Refer to the header bottom type.

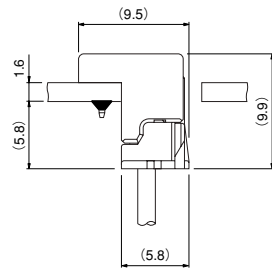

PA Receptacle
(Standard type)
+
PA bottom type header

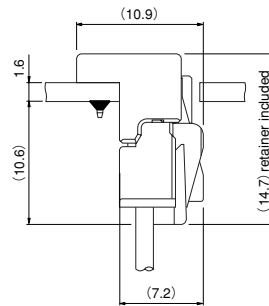

PA Receptacle
(Retainer mountable type)
+
PA bottom type header

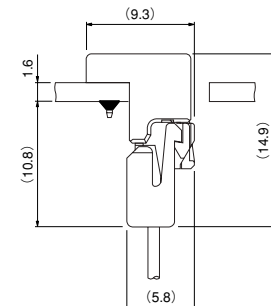

PAF Receptacle
+
PA bottom type header

High box type

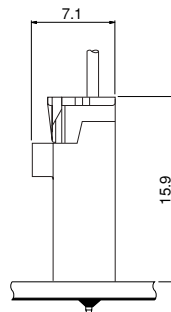
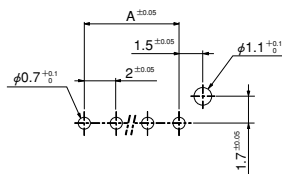

PA Receptacle
(Standard type)
+
PA high box type header

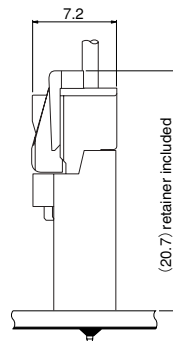

PA Receptacle
(Retainer mountable type)
+
PA high box type header

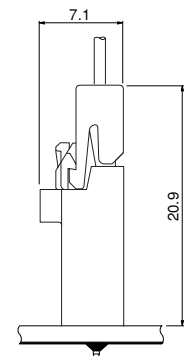

PAF Receptacle
+
PA high box type header

Note: 1. The above figure is the figure viewed from the connector mounting side.

2. Tolerances are non-cumulative: ±0.05mm for all centers.

3. Hole dimensions differ according to the kind of PC board and piercing method. The dimensions above should serve as a guideline. Contact JST for details.

PA FAMILY SERIES /PA•PAF•PAL CONNECTOR

SMT type

Top entry type

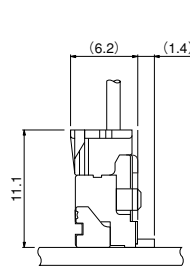
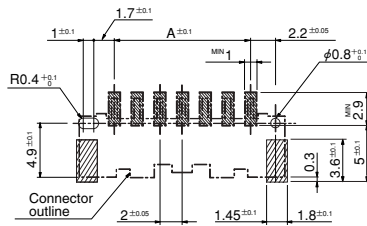

PA Receptacle
(Standard type)
+
PA Header

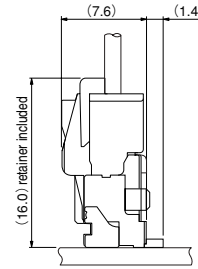

PA Receptacle
(Retainer mountable type)
+
PA Header

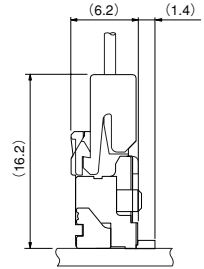

PAF Receptacle
+
PA Header

Side entry type

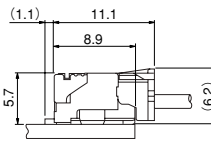
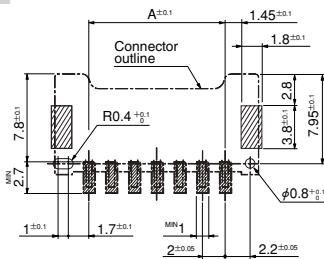

PA Receptacle
(Standard type)
+
PA side entry type header

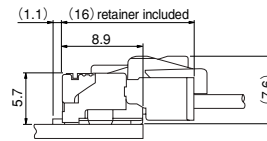

PA Receptacle
(Retainer mountable type)
+
PA side entry type header

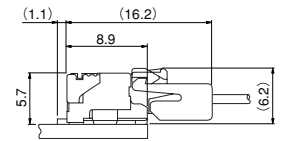

PAF Receptacle
+
PA side entry type header

- Note: 1. The above figure is the figure viewed from the connector mounting side.
2. Tolerances are non-cumulative: $\pm 0.05\text{mm}$ for all centers.
3. The dimensions above should serve as a guideline. Contact JST for details.

Wire-to-wire

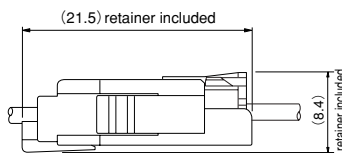

PA Receptacle
(Standard type)
+
PAL Receptacle

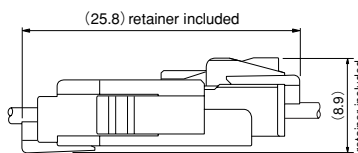

PA Receptacle
(Retainer mountable type)
+
PAL Receptacle

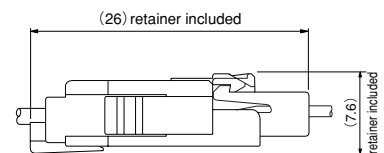

PAF Receptacle
+
PAL Receptacle

PA FAMILY SERIES /PA CONNECTOR (Crimp style Standard type)

Contact

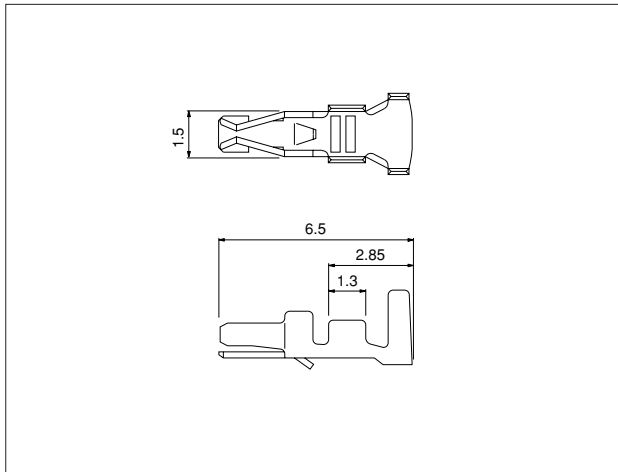

Model No.	Applicable wire		Insulation O.D. (mm)	Q'ty / reel
	mm ²	AWG #		
SPHD-001T-P0.5	0.13~0.33	26~22	1.0~1.5	8,000
SPHD-002T-P0.5	0.08~0.21	28~24	0.9~1.5	8,000

Material and Finish

Phosphor bronze, tin-plated (reflow treatment)

RoHS compliance

Contact	Crimping machine	Applicator		
		Crimp applicator	Dies	Crimp applicator with dies
SPHD-002T-P0.5	AP-K2N	MKS-L-10	MK/SPHD-002-05	APLMK SPHD002-05
		*MKS-SC-10	SC/SPHD-002-05	APLSC SPHD002-05
SPHD-001T-P0.5		MKS-L-10	MK/SPHD-001-05	APLMK SPHD001-05
		*MKS-SC-10	SC/SPHD-001-05	APLSC SPHD001-05

Note: *Strip-crimp applicator

Housing

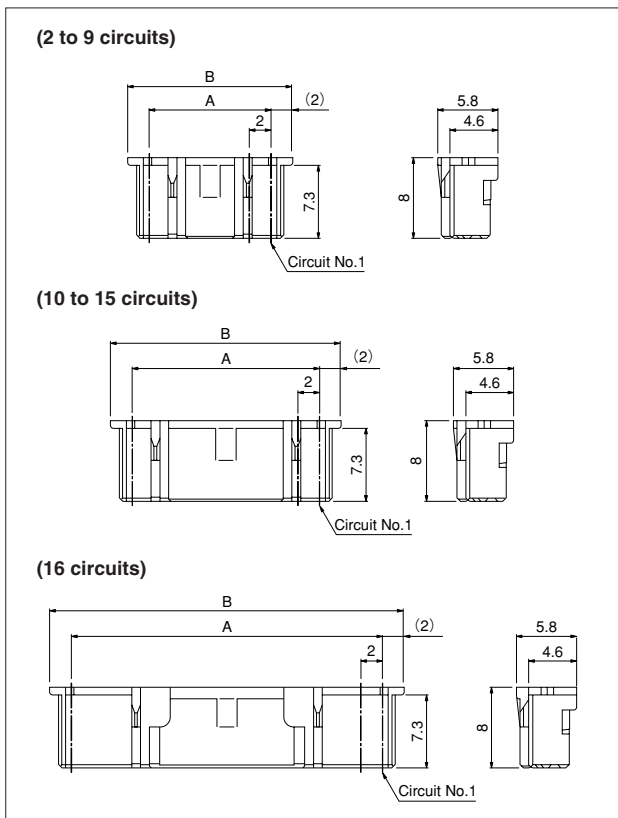

Circuits	Model No.	Dimensions (mm)		Q'ty / bag
		A	B	
2	PAP-02V-S	2.0	6.0	1,000
3	PAP-03V-S	4.0	8.0	1,000
4	PAP-04V-S	6.0	10.0	1,000
5	PAP-05V-S	8.0	12.0	1,000
6	PAP-06V-S	10.0	14.0	1,000
7	PAP-07V-S	12.0	16.0	1,000
8	PAP-08V-S	14.0	18.0	1,000
9	PAP-09V-S	16.0	20.0	1,000
10	PAP-10V-S	18.0	22.0	1,000
11	PAP-11V-S	20.0	24.0	1,000
12	PAP-12V-S	22.0	26.0	1,000
13	PAP-13V-S	24.0	28.0	1,000
14	PAP-14V-S	26.0	30.0	1,000
15	PAP-15V-S	28.0	32.0	1,000
16	PAP-16V-S	30.0	34.0	1,000

Material

PA 66, UL94V-0, natural (white)

RoHS compliance

<For reference> As the color identification, the following alphabet shall be put in the underlined part. For availability, delivery and minimum order quantity, contact JST.

ex. **PAP-02V-S**

S...natural (white)

K...black R...red E...blue M...green O...orange N...brown

P...purple PK...pink Y...yellow L...lemon yellow FY...vivid yellow

LE...light blue H...gray TR...tomato red

Through-hole type shrouded header

Top entry type (2 to 9 circuits)

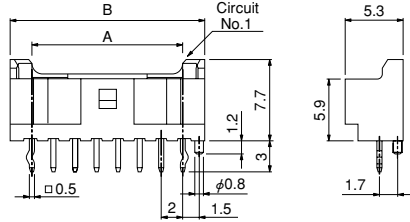

(10 to 15 circuits)

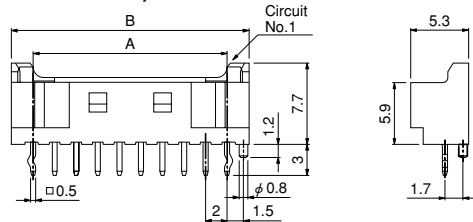

(16 circuits)

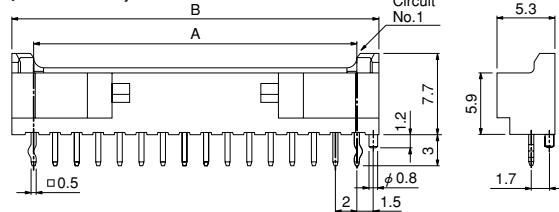

Side entry type (2 to 9 circuits)

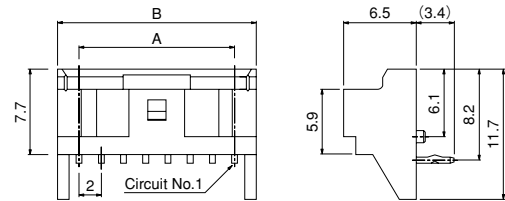

(10 to 15 circuits)

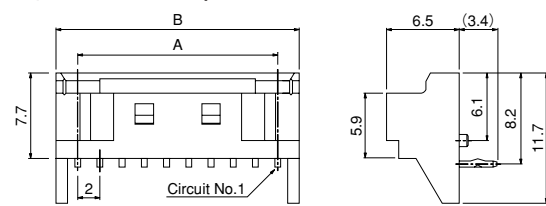

(16 circuits)

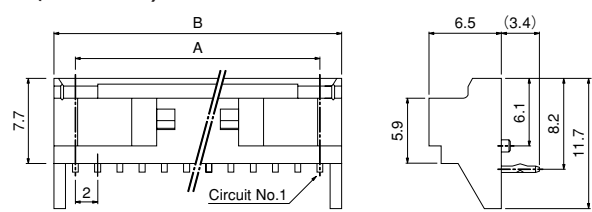

Top entry type

Circuits	Model No.		Dimensions (mm)		Q'ty / box
	Without a boss	With a boss	A	B	
2 (Note1)	B02B-PAFYK-A	B02B-PAFYK-1A	2.0	6.0	1,000
2	B02B-PASK	B02B-PASK-1	2.0	6.0	1,000
3	B03B-PASK	B03B-PASK-1	4.0	8.0	1,000
4	B04B-PASK	B04B-PASK-1	6.0	10.0	1,000
5	B05B-PASK	B05B-PASK-1	8.0	12.0	500
6	B06B-PASK	B06B-PASK-1	10.0	14.0	500
7	B07B-PASK	B07B-PASK-1	12.0	16.0	500
8	B08B-PASK	B08B-PASK-1	14.0	18.0	500
9	B09B-PASK	B09B-PASK-1	16.0	20.0	500
10	B10B-PASK	B10B-PASK-1	18.0	22.0	500
11	B11B-PASK	B11B-PASK-1	20.0	24.0	250
12	B12B-PASK	B12B-PASK-1	22.0	26.0	250
13	B13B-PASK	B13B-PASK-1	24.0	28.0	250
14	B14B-PASK	B14B-PASK-1	26.0	30.0	250
15	B15B-PASK	B15B-PASK-1	28.0	32.0	250
16	B16B-PASK	B16B-PASK-1	30.0	34.0	250

Material and Finish

Post: Copper alloy, copper-undercoated, tin-plated (reflow treatment)
 Wafer: Glass-filled PBT, UL94V-0, natural (white)
 (Note1) PA 66, UL94V-0, vivid yellow

RoHS compliance This product displays (LF)(SN) on a label.

<For reference> As the color identification, the following alphabet shall be put in the underlined part. For availability, delivery and minimum order quantity, contact JST.

ex. **B02B-PASK**
 S...natural (white)
 K...black R...red E...blue M...green O...orange N...brown
 P...purple PK...pink Y...yellow L...lemon yellow FY...vivid yellow
 LE...light blue H...gray TR...tomato red

Side entry type

Circuits	Model No.	Dimensions (mm)		Q'ty / box
		A	B	
2	S02B-PASK-2	2.0	6.0	1,000
3	S03B-PASK-2	4.0	8.0	1,000
4	S04B-PASK-2	6.0	10.0	500
5	S05B-PASK-2	8.0	12.0	500
6	S06B-PASK-2	10.0	14.0	500
7	S07B-PASK-2	12.0	16.0	250
8	S08B-PASK-2	14.0	18.0	250
9	S09B-PASK-2	16.0	20.0	250
10	S10B-PASK-2	18.0	22.0	250
11	S11B-PASK-2	20.0	24.0	250
12	S12B-PASK-2	22.0	26.0	250
13	S13B-PASK-2	24.0	28.0	200
14	S14B-PASK-2	26.0	30.0	200
15	S15B-PASK-2	28.0	32.0	200
16	S16B-PASK-2	30.0	34.0	200

Material and Finish

Post: Copper alloy, copper-undercoated, tin-plated (reflow treatment)
 Wafer: Glass-filled PBT, UL94V-0, natural (white)

RoHS compliance This product displays (LF)(SN) on a label.

<For reference> As the color identification, the following alphabet shall be put in the underlined part. For availability, delivery and minimum order quantity, contact JST.

ex. **S03B-PASK-2**
 S...natural (white)
 K...black R...red E...blue M...green O...orange N...brown
 P...purple PK...pink Y...yellow L...lemon yellow LE...light blue
 H...gray TR...tomato red

Through-hole type shrouded header

Bottom type

(5, 8 circuits)

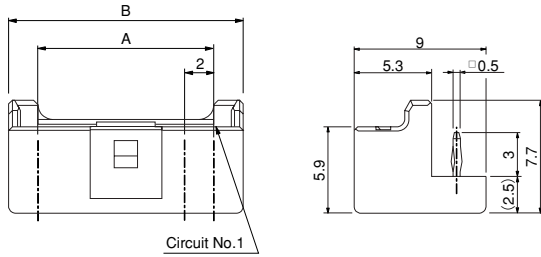

(11, 12 circuits)

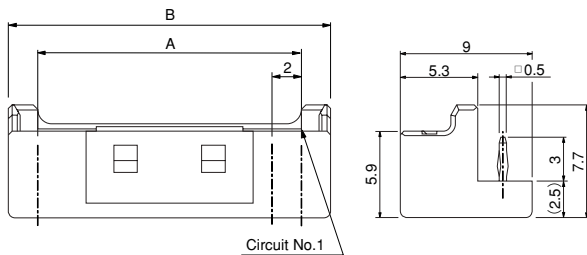

Circuits	Model No.	Dimensions(mm)				Q'ty / bag
		A	B	C	D	
5	BE05B-PASK	8.0	12.0	12.4	5.5	300
8	BE08B-PASK	14.0	18.0	18.4	5.5	200
11	BE11B-PASK	20.0	24.0	24.4	12.0	150
12	BE12B-PASK	22.0	26.0	26.4	12.0	150

Material and Finish

Post: Copper alloy, copper-undercoated, tin-plated (reflow treatment)
Wafer: Glass-filled PBT, UL94V-0, natural

RoHS compliance This product displays (LF)(SN) on a label.
Note: C and D dimensions; Refer to the PCB layout bottom type (P3).

Shrouded header <High box type>

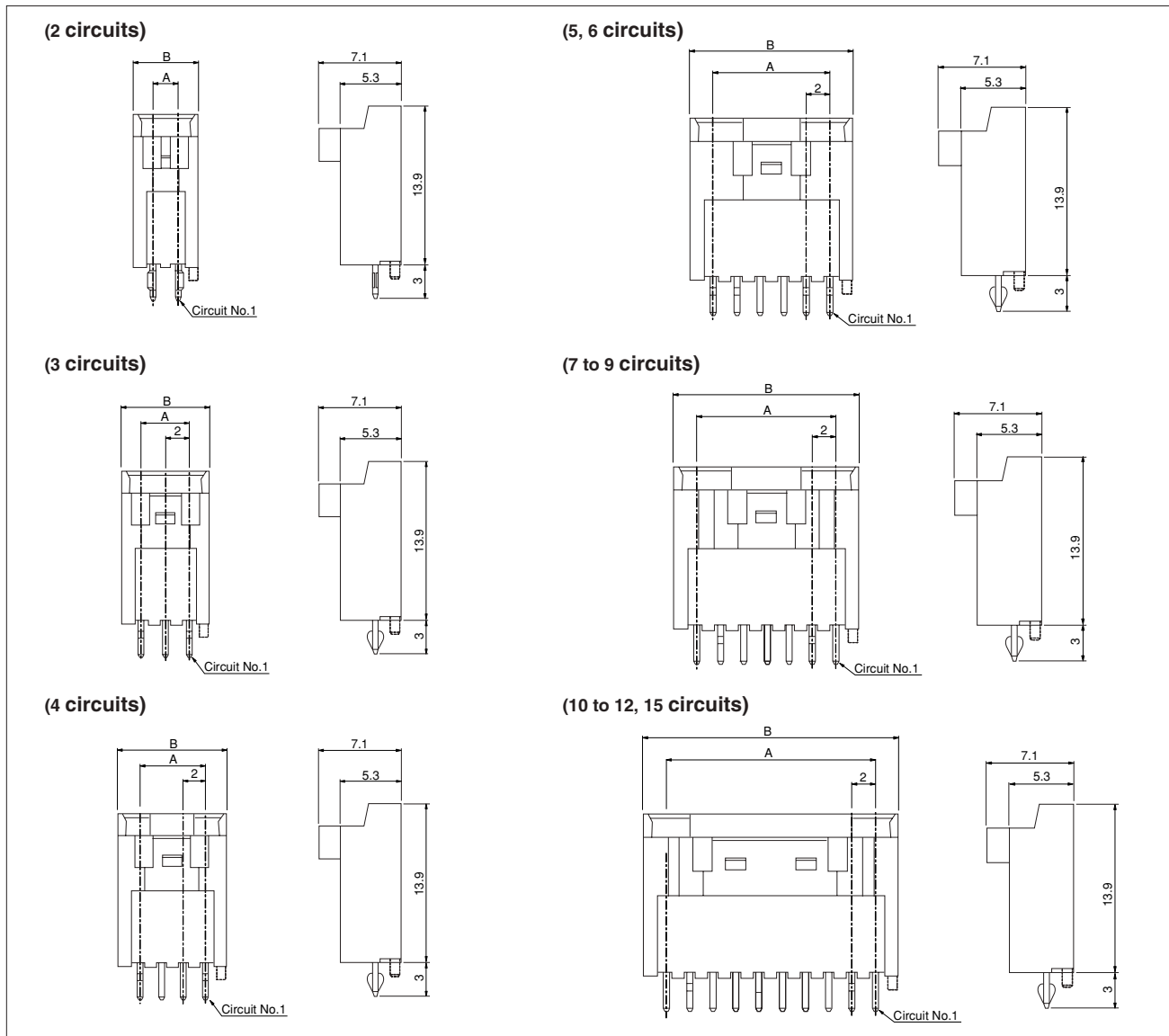

Circuits	Model No.		Dimensions(mm)		Q'ty / box
	Without a boss	With a boss	A	B	
2	BH02B-PASK	BH02B-PASK-1	2.0	6.0	900
3	BH03B-PASK	BH03B-PASK-1	4.0	8.0	675
4	BH04B-PASK	BH04B-PASK-1	6.0	10.0	525
5	BH05B-PASK	BH05B-PASK-1	8.0	12.0	450
6	BH06B-PASK	BH06B-PASK-1	10.0	14.0	375
7	BH07B-PASK	BH07B-PASK-1	12.0	16.0	325
8	BH08B-PASK	BH08B-PASK-1	14.0	18.0	300
9	BH09B-PASK	BH09B-PASK-1	16.0	20.0	250
10	BH10B-PASK	BH10B-PASK-1	18.0	22.0	225
11	BH11B-PASK	BH11B-PASK-1	20.0	24.0	225
12	BH12B-PASK	BH12B-PASK-1	22.0	26.0	200
15	BH15B-PASK	BH15B-PASK-1	28.0	32.0	150

Material and Finish

Post: Copper alloy, copper-undercoated, tin-plated (reflow treatment)
 Wafer: Glass-filled PBT, UL94V-0, natural (white)

RoHS compliance This product displays (LF)(SN) on a label.

PA FAMILY SERIES

SMT type shrouded header

Top entry type

(2 to 3 circuits)

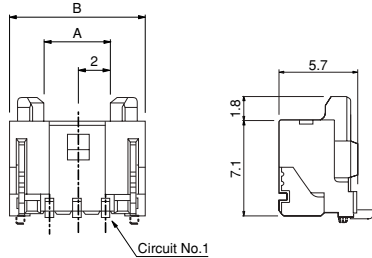

(4 to 9 circuits)

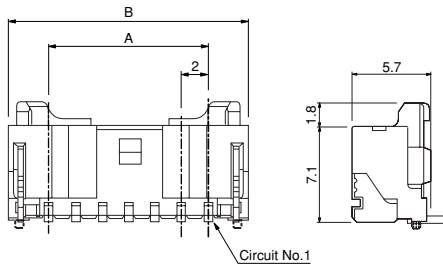

(10 to 13, 15 circuits)

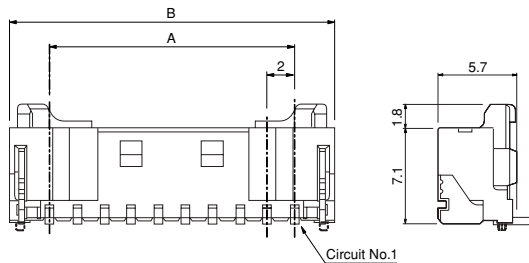

Side entry type

(2 to 3 circuits)

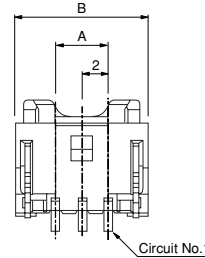

(4 to 9 circuits)

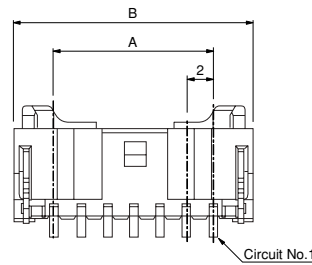

(10 to 13, 15 circuits)

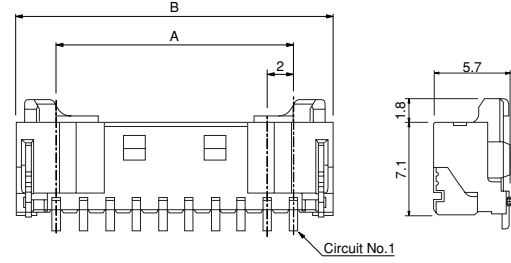

Top entry type

Circuits	Model No.		Dimensions(mm)		Q'ty / reel
	Without a boss	With a boss	A	B	
2	BM02B-PASS-(*)	BM02B-PASS-1-(*)	2.0	8.0	500
3	BM03B-PASS-(*)	BM03B-PASS-1-(*)	4.0	10.0	500
4	BM04B-PASS-(*)	BM04B-PASS-1-(*)	6.0	12.0	500
5	BM05B-PASS-(*)	BM05B-PASS-1-(*)	8.0	14.0	500
6	BM06B-PASS-(*)	BM06B-PASS-1-(*)	10.0	16.0	500
7	BM07B-PASS-(*)	BM07B-PASS-1-(*)	12.0	18.0	500
8	BM08B-PASS-(*)	BM08B-PASS-1-(*)	14.0	20.0	500
9	BM09B-PASS-(*)	BM09B-PASS-1-(*)	16.0	22.0	500
10	BM10B-PASS-(*)	BM10B-PASS-1-(*)	18.0	24.0	500
11	BM11B-PASS-(*)	BM11B-PASS-1-(*)	20.0	26.0	500
12	BM12B-PASS-(*)	BM12B-PASS-1-(*)	22.0	28.0	500
13	BM13B-PASS-(*)	BM13B-PASS-1-(*)	24.0	30.0	500
15	BM15B-PASS-(*)	BM15B-PASS-1-(*)	28.0	34.0	500

Material and Finish

Post: Copper alloy, copper-undercoated, tin-plated (reflow treatment)
 Wafer: PA, UL94V-0, natural (ivory)
 Solder tab: Copper alloy, copper-undercoated, tin-plated (reflow treatment)

Side entry type

Circuits	Model No.		Dimensions(mm)		Q'ty / reel
	Without a boss	With a boss	A	B	
2	SM02B-PASS-(*)	SM02B-PASS-1-(*)	2.0	8.0	1,000
3	SM03B-PASS-(*)	SM03B-PASS-1-(*)	4.0	10.0	1,000
4	SM04B-PASS-(*)	SM04B-PASS-1-(*)	6.0	12.0	1,000
5	SM05B-PASS-(*)	SM05B-PASS-1-(*)	8.0	14.0	1,000
6	SM06B-PASS-(*)	SM06B-PASS-1-(*)	10.0	16.0	1,000
7	SM07B-PASS-(*)	SM07B-PASS-1-(*)	12.0	18.0	1,000
8	SM08B-PASS-(*)	SM08B-PASS-1-(*)	14.0	20.0	1,000
9	SM09B-PASS-(*)	SM09B-PASS-1-(*)	16.0	22.0	1,000
10	SM10B-PASS-(*)	SM10B-PASS-1-(*)	18.0	24.0	1,000
11	SM11B-PASS-(*)	SM11B-PASS-1-(*)	20.0	26.0	1,000
12	SM12B-PASS-(*)	SM12B-PASS-1-(*)	22.0	28.0	1,000
13	SM13B-PASS-(*)	SM13B-PASS-1-(*)	24.0	30.0	1,000
15	SM15B-PASS-(*)	SM15B-PASS-1-(*)	28.0	34.0	1,000

Material and Finish

Post: Copper alloy, copper-undercoated, tin-plated (reflow treatment)
 Wafer: PA, UL94V-0, natural (ivory)
 Solder tab: Copper alloy, copper-undercoated, tin-plated (reflow treatment)

RoHS compliance This product displays (LF)(SN) on a label.

Note: (*): TF...taping product

TFT...taping product with suction tape.

RoHS compliance This product displays (LF)(SN) on a label.

Note: (*): TB...taping product

TBT...taping product with suction tape.

PA FAMILY SERIES /PA CONNECTOR (Crimp style Retainer mountable type)

Contact

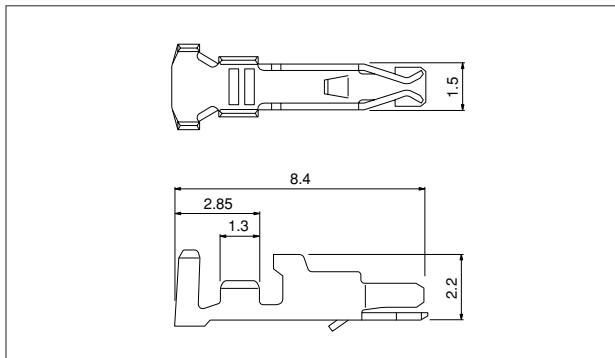

Model No.	Applicable wire		Insulation O.D. (mm)	Q'ty / reel
	mm ²	AWG #		
SPA-001T-P0.5	0.13~0.33	26~22	0.9~1.5	10,000

Material and Finish

Phosphor bronze, tin-plated (reflow treatment)

RoHS compliance

Contact	Crimping machine	Applicator		
		Crimp applicator	Dies	Crimp applicator with dies
SPA-001T-P0.5	AP-K2N	MKS-L	MK/SPA-001-05	APLMK SPA001-05
		—	—	—

Housing

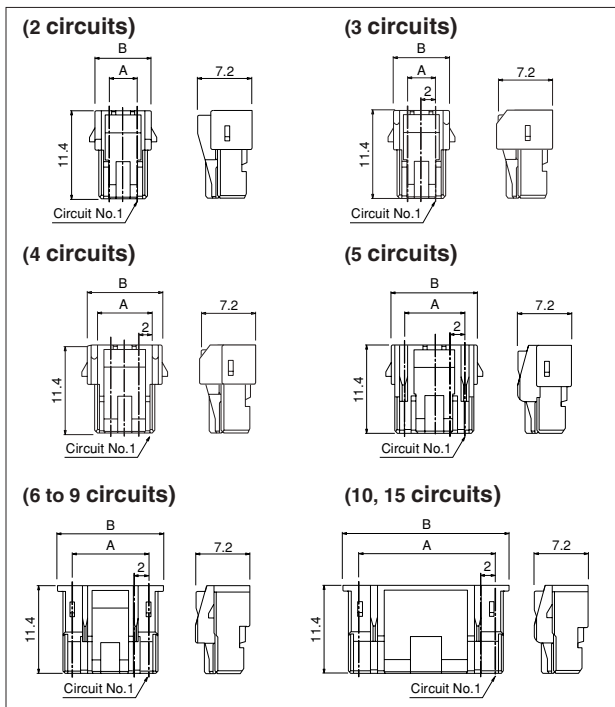

Circuits	Model No.	Dimensions(mm)		Q'ty / bag
		A	B	
2	PARP-02V	2.0	5.4	1,000
3	PARP-03V	4.0	7.4	1,000
4	PARP-04V	6.0	9.4	1,000
5	PARP-05V	8.0	11.4	1,000
6	PARP-06V	10.0	14.0	1,000
7	PARP-07V	12.0	16.0	1,000
8	PARP-08V	14.0	18.0	1,000
9	PARP-09V	16.0	20.0	1,000
10	PARP-10V	18.0	22.0	1,000
15	PARP-15V	28.0	32.0	500

Material

PA 66, UL94V-0, natural (white)

RoHS compliance

<For reference> As the color identification,
the following alphabet shall be put in the underlined part.
For availability, delivery and minimum order quantity, contact JST.

ex. **PARP-02V-oo**
(blank)...natural (white)
R...red E...blue Y...yellow M...green

Retainer

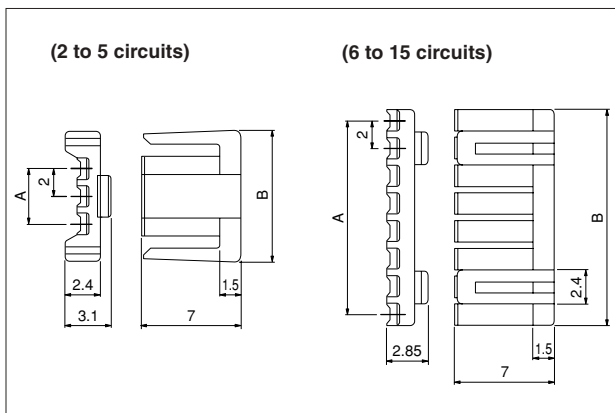

Circuits	Model No.	Dimensions(mm)		Q'ty / bag
		A	B	
2	PMS-02V-S	2.0	7.3	1,000
3	PMS-03V-S	4.0	9.3	1,000
4	PMS-04V-S	6.0	11.3	1,000
5	PMS-05V-S	8.0	13.3	1,000
6	PMS-06V-S	10.0	11.55	1,000
7	PMS-07V-S	12.0	13.55	1,000
8	PMS-08V-S	14.0	15.55	1,000
9	PMS-09V-S	16.0	17.55	1,000
10	PMS-10V-S	18.0	19.55	1,000
15	PMS-15V-S	28.0	29.55	1,000

Material

Glass-filled PA 66, UL94V-0, natural (ivory)

RoHS compliance

PA FAMILY SERIES /PAF CONNECTOR (Insulation displacement type)

Receptacle

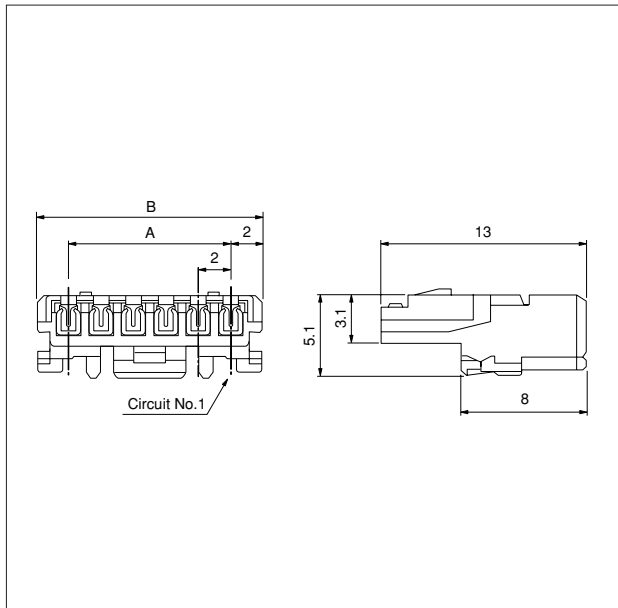

Circuits	Model No.	Dimensions(mm)		Q'ty / box
		A	B	
2	02PAF-6S	2.0	6.0	1,000
3	03PAF-6S	4.0	8.0	1,000
4	04PAF-6S	6.0	10.0	500
5	05PAF-6S	8.0	12.0	500
6	06PAF-6S	10.0	14.0	500
7	07PAF-6S	12.0	16.0	500
8	08PAF-6S	14.0	18.0	250
9	09PAF-6S	16.0	20.0	250
10	10PAF-6S	18.0	22.0	250
11	11PAF-6S	20.0	24.0	250
12	12PAF-6S	22.0	26.0	250
13	13PAF-6S	24.0	28.0	250
14	14PAF-6S	26.0	30.0	250
15	15PAF-6S	28.0	32.0	250
*16	16PAF-6S	30.0	34.0	250

Material and Finish

Contact: Phosphor bronze, tin-plated (reflow treatment)
Housing: PA 66, UL94V-0, natural (white)

RoHS compliance

Note: *Marked product is not UL/CSA approved.

<For reference> As the color identification, the following alphabet shall be put in the underlined part. For availability, delivery and minimum order quantity, contact JST.

ex. **02PAF-6S**
S...natural (white)
R...red E...blue M...green Y...yellow

Retainer

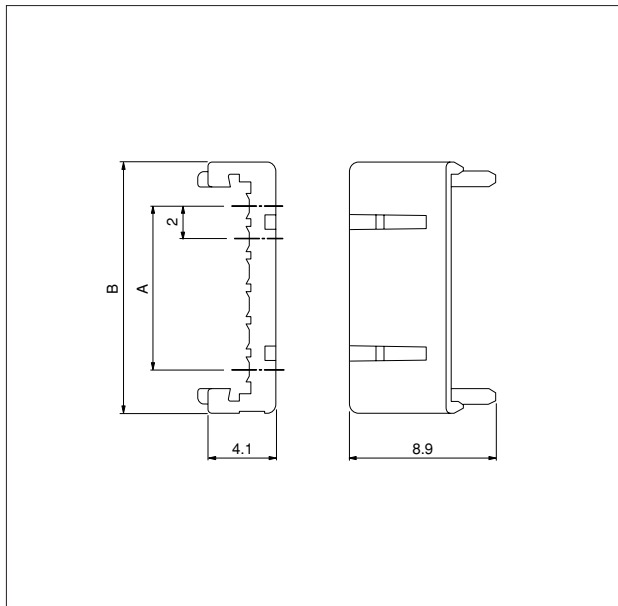

Circuits	Model No.	Dimensions(mm)		Q'ty / bag
		A	B	
2	PAFS-02V-S	2.0	7.4	1,000
3	PAFS-03V-S	4.0	9.4	1,000
4	PAFS-04V-S	6.0	11.4	1,000
5	PAFS-05V-S	8.0	13.4	1,000
6	PAFS-06V-S	10.0	15.4	1,000
7	PAFS-07V-S	12.0	17.4	1,000
8	PAFS-08V-S	14.0	19.4	1,000
* 9	PAFS-09V-S	16.0	21.4	1,000
*10	PAFS-10V-S	18.0	23.4	1,000
*11	PAFS-11V-S	20.0	25.4	1,000
*12	PAFS-12V-S	22.0	27.4	1,000
*13	PAFS-13V-S	24.0	29.4	1,000
*14	PAFS-14V-S	26.0	31.4	1,000
*15	PAFS-15V-S	28.0	33.4	1,000

Material

Glass-filled PA 66, UL94V-0, natural (ivory)

RoHS compliance

Note: *Marked products are not UL/CSA approved.

PA FAMILY SERIES /PAL CONNECTOR (Wire-to-wire type)

Contact

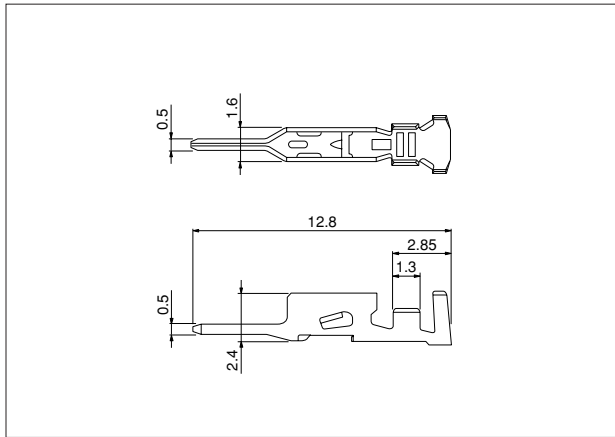

Model No.	Applicable wire		Insulation O.D. (mm)	Q'ty / reel
	mm ²	AWG #		
SPAL-001T-P0.5	0.13~0.33	26~22	1.0~1.5	10,000
SPAL-002T-P0.5	0.08~0.21	28~24	0.9~1.5	10,000

Material and Finish

Phosphor bronze, tin-plated (reflow treatment)

RoHS compliance

Contact	Crimping machine	Applicator		
		Crimp applicator	Dies	Crimp applicator with dies
SPAL-001T-P0.5	AP-K2N	MKS-L	MK/SPAL-001-05	APLMK SPAL001-05
		—	—	—
SPAL-002T-P0.5	AP-K2N	MKS-L	MK/SPAL-002-05	APLMK SPAL002-05
		—	—	—

Housing

Without panel locks (2 to 5 circuits)

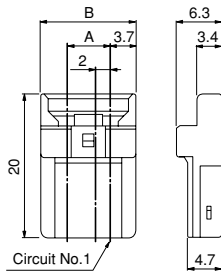

(6 to 8 circuits)

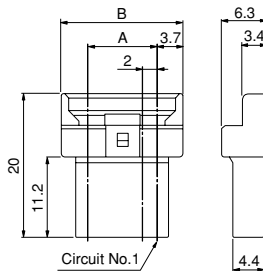

With panel locks (2 to 4 circuits)

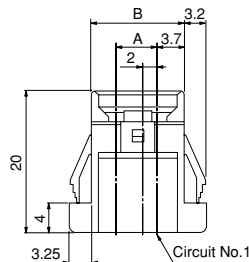

Panel layout

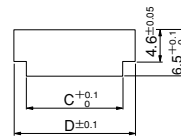

(6 to 8 circuits)

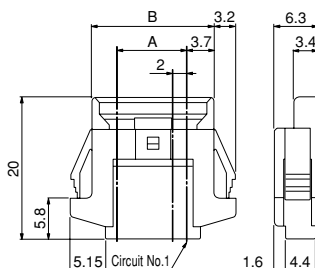

Panel layout

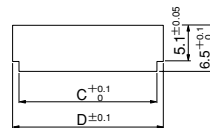

Circuits	Model No.	Dimensions(mm)		Q'ty / bag
		A	B	
2	PALR-02VF	2.0	9.4	1,000
3	PALR-03VF	4.0	11.4	1,000
4	PALR-04VF	6.0	13.4	1,000
5	PALR-05VF	8.0	15.4	1,000
6	PALR-06VF	10.0	17.4	1,000
7	PALR-07VF	12.0	19.4	1,000
8	PALR-08VF	14.0	21.4	1,000

Material

PA 66, UL94V-0, natural (white)

RoHS compliance

Circuits	Model No.	Dimensions(mm)				Q'ty / bag
		A	B	C	D	
2	PALR-02V	2.0	9.4	9.8	13.4	1,000
3	PALR-03V	4.0	11.4	11.8	15.4	1,000
4	PALR-04V	6.0	13.4	13.8	17.4	1,000
6	PALR-06V	10.0	17.4	19.8	21.4	1,000
7	PALR-07V	12.0	19.4	21.8	23.4	1,000
8	PALR-08V	14.0	21.4	23.8	25.4	1,000

Material

PA 66, UL94V-0, natural (white)

RoHS compliance

<For reference> As the color identification, the following alphabet shall be put in the underlined part. For availability, delivery and minimum order quantity, contact JST.

ex. **PALR-02V(F)-oo**
(blank)...natural (white)
R...red E...blue M...green Y...yellow

Retainer

Retainers are interchangeable with those of the PA crimp style retainer mountable type.