

Tantalum Surface Mount Capacitors

Standard Tantalum

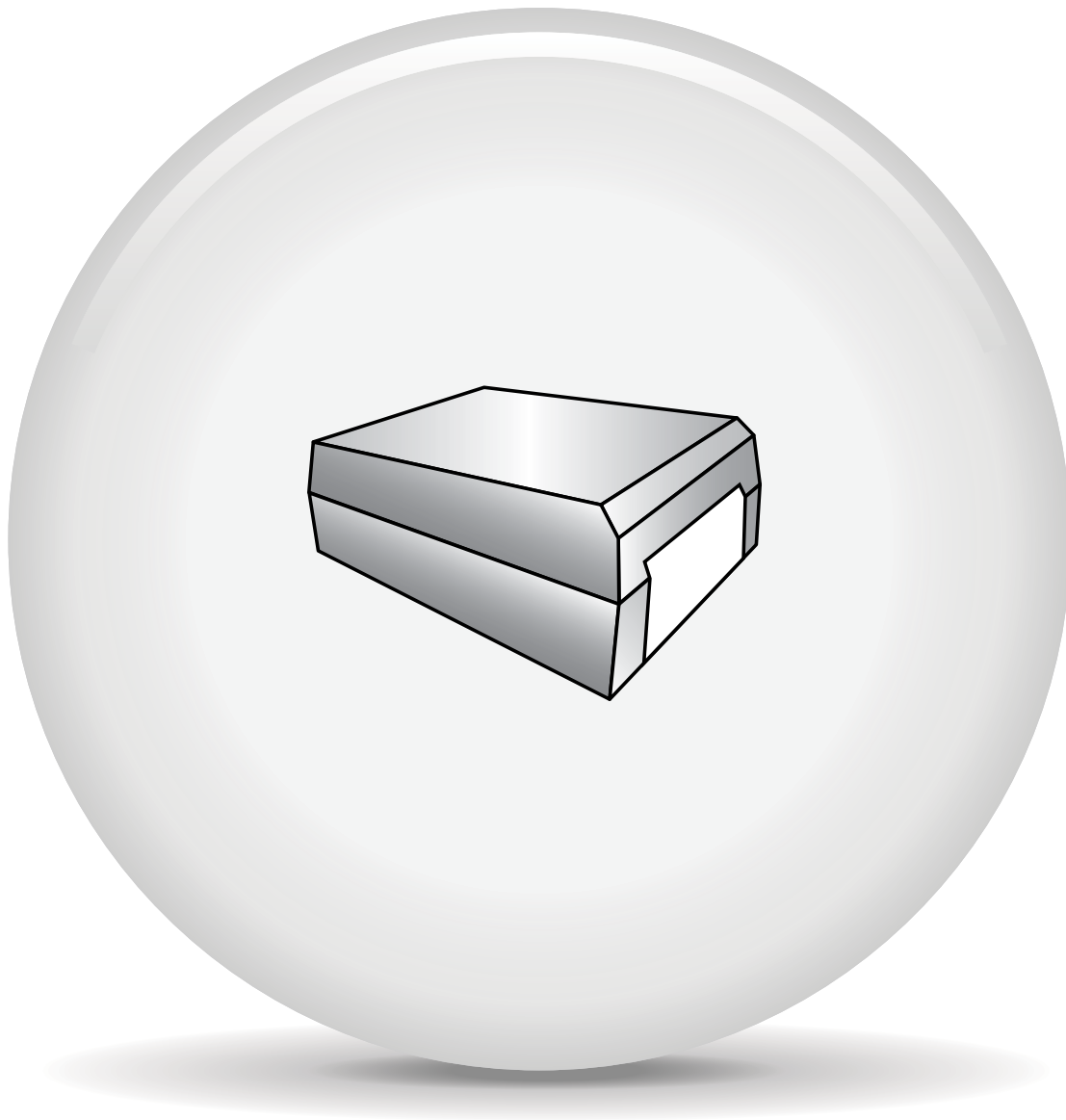

25-06081

One world. One KEMET.

The Capacitance Company
KEMET
CHARGED.®

Table of Contents Page

Why Choose KEMET	3
T491 Industrial Grade MnO ₂ Series	9
T489 Low DC Leakage MnO ₂ Series	26
Packaging Information	37
KEMET Corporation Sales Offices	42
Other KEMET Resources	43



One world. One source. One KEMET.

No bouncing from supplier to supplier to find what you need. No multiple web sites and phone calls to get answers.

When you partner with KEMET, our entire global organization seamlessly provides you with the coordinated action and service you need. We're your single, integrated source for capacitance solutions worldwide, offering 95% of possible dielectric solutions, to cover practically any application. With new, innovative products year after year after year. Global availability. Full design collaboration, with fast custom design and prototyping to give your new products a competitive edge. Plus consistent quality, reliability and on-time delivery.

All from one company that's easy to work with and totally dedicated to your success. For anything to do with capacitance, call *The Capacitance Company* – KEMET.



Looking for a hassle-free source for 95% of possible dielectric solutions?

KEMET is the place for one-stop dielectric shopping. We offer our customers the broadest selection of capacitor technologies in the industry, including tantalum, ceramic, aluminum, electrolytic, film and paper.

But the range of products is only the beginning. You simply won't find an electronic components manufacturer more determined to find new technological solutions to customer problems, or more committed to product quality and on-time delivery – in every case, lowering your total cost of ownership as much as we possibly can. It's how we've helped customers succeed for more than 90 years. And it's how we're helping them succeed today.



We're everywhere you need us to be.

AMERICA

Canada
Mexico
USA

EMEA

Bulgaria
Finland
France
Germany
Italy
Portugal
Sweden
Switzerland
United Kingdom

ASIA-PACIFIC

China
Hong Kong
India
Indonesia
Japan
Malaysia
Singapore
Taiwan

The next time you board an airplane, boot up your computer or read about a breakthrough medical device, a piece of our technology is likely involved. KEMET customers include nearly all of the world's major electronics original equipment manufacturers, manufacturing services companies and electronics distributors. High Reliability versions of our capacitors are even in outer space, part of every important military and aerospace effort of the past 60 years, from the first Telstar satellite and Apollo 11 to the Patriot missile, International Space Station and Mars Pathfinder.

Our sales offices can't be quite as ubiquitous as our products, but we do pride ourselves on being where you need us. This map shows you our sales offices around the world.

As you can see, we're not only easy to work with, we're easy to find. And we're more than ready to be your single source capacitance solutions supplier.

One world. One source. One KEMET.

One WORLD One Brand One Strategy One Focus One Team One KEMET



Why The Capacitance Company is also the “Easy-To-Buy-From” company.

When you choose KEMET, you’ll enjoy a level of responsiveness you just won’t get from any other component manufacturer. You simply won’t find an electronic components manufacturer more passionate about customer service. Our innovative service offerings and superior localized support are known throughout the industry, powered by our global, customer-focused sales organization and worldwide logistics capabilities. We’re 100% committed to serving any customer, anywhere, and meeting customer needs when they need to be met.

Whether you need rush samples, technical assistance, in-person consultations or accelerated custom design, design collaboration and prototype services, we have a solution. If it’s anything to do with capacitance, we can help – and help fast.



Working to make a better world.

At KEMET, we're proud to work with customers to develop products that truly make the world a better, safer, more connected place to live – from hand-held devices to automotive systems to the greenest energy technology.

As a company, KEMET is dedicated to economically, environmentally and socially sustainable development. We've adopted the Electronic Industry Code of Conduct (EICC), addressing all aspects of corporate responsibility. All of our commercial-grade products are available in RoHS-compliant versions with Pb-free terminations. Our manufacturing facilities have won numerous environmental excellence awards and recognitions. And our supply chain is certified to be sourced from areas that are neither environmentally protected nor under conflict.

After all, we believe that doing the right thing is in everyone's interest.



Which capacitor is right for you?

As The Capacitance Company, we make over 95% of possible dielectric solutions – the broadest selection of capacitor technologies in the industry. By offering a wide variety of dielectrics, dimensions, voltages, temperature characteristics and terminations, KEMET capacitors satisfy an expansive range of customer requirements and applications.

In fact, if the capacitor you need hasn't been invented, it's only because you haven't asked. We can quickly develop custom products and carry out early-stage manufacturing through our accelerated collaboration services. Available through our global innovation and manufacturing centers around the world, accelerated collaboration brings together the necessary people, equipment and facilities together to get the job done, on time and in budget.

Of course, when you're under pressure to design smaller and smaller products with greater and greater functionality, there's no time for the traditional back-and-forth with your suppliers. With KEMET, you get direct contact to the engineers and other professionals who can help you successfully solve your design problems, and in record time. We deal personally with customers to ascertain the new part types needed for their next-generation products. In many cases, we can go from start to samples in only four months.

We've helped some of the world's most prominent electronics companies slash time to market and gain significant windows of competitive advantage. We can do the same for you, too.

Overview

The KEMET T491 Series, designed specifically for today's highly automated surface mount processes and equipment, is the leading choice for surface mount designs. The T491 combines KEMET's proven solid tantalum technology, acclaimed and respected throughout the world, with the latest in materials, processes and automation, resulting in unsurpassed total performance and value.

This product meets or exceeds the requirements of EIA standard 535BAAC. The physical outline and dimensions of this series conform to this global standard. Five low profile case sizes are available in the T491 Series. The R/2012-12, S/3216-12 and T/3528-12 case sizes have a maximum height of 1.2 mm. The U/6032-15 size has a maximum height of 1.5 mm, and the V/7343-20 has a maximum height of 2.0 mm.

The T491 standard terminations are 100% matte tin and provide excellent wetting characteristics and compatibility with today's surface mount solder systems. Tin/lead (Sn/Pb) terminations are available upon request for any part number. Gold-plated terminations are also available for use with conductive epoxy attachment processes. The symmetrical terminations offer total compliancy to provide the thermal and mechanical stress relief required with today's technology. Lead frame attachments to the tantalum pellet are made via a microprocessor-controlled welding operation, and a high temperature silver epoxy adhesive system.

Standard packaging of these devices is tape and reel in accordance with EIA 481-D. This system provides perfect compatibility with all tape-fed placement units.

Benefits

- Meets or Exceeds EIA Standard 535BAAC
 - Taped and Reeled per EIA 481-D
 - Symmetrical, Compliant Terminations
 - Optical Gold-Plated Terminations
 - Laser-marked Case
 - 100% Surge current test on C, D, E, U, V, X sizes
 - Halogen Free Epoxy
 - Capacitance 0.1 μ F to 1000 μ F
 - Tolerance \pm 10%, \pm 20%
 - Voltage 2.5-50 VDC
 - Extended Range Values
 - Low Profile Case Sizes
 - RoHS Compliance & Lead Free Terminations
- (See www.kemet.com for transition information)
- Operating Temperature: -55°C to +125°C

Applications

Typical applications include decoupling and filtering in industrial and automotive end applications such as DC/DC converters, portable electronics, telecommunications, and control units.



Environmental Compliance

RoHS Compliant (6/6)* according to Directive 2002/95/EC

*When ordered with 100% Sn Solder

SPICE

For a detailed analysis of specific part numbers, please visit kemet.com for a free download of KEMET's SPICE software. The KEMET SPICE program is freeware intended to aid design engineers in analyzing the performance of these capacitors over frequency, temperature, ripple, and DC bias conditions.

Ordering Information – T491 Industrial Grade MnO₂ Series

T	491	X	157	K	020	A	T	
Capacitor Class	Series	Case Size	Capacitance Code (pF)	Capacitance Tolerance	Voltage	Failure Rate/Design	Lead Material	Packaging (C-Spec)
T = Tantalum	Industrial	A = 3216-18 B = 3528-21 C = 6032-28 D = 7343-31 E = 7260-38 R = 2012-12 S = 3216-12 T = 3528-12 U = 6032-15 V = 7343-20 X = 7343-43	First two digits represent significant figures. Third digit specifies number of zeros.	K = ±10% M = ±20%	2R5 = 2.5V 003 = 3V 004 = 4V 006 = 6.3V 010 = 10V 016 = 16V 020 = 20V 025 = 25V 035 = 35V 050 = 50V	A = N/A	T = 100% Matte Tin (Sn) Plated* H = Standard Solder Coated (SnPb 5% Pb minimum) G = Gold Plated (A, B, C, D, X only) N = Non-Magnetic 100% Tin (Sn) M = Non-Magnetic (SnPb)	Blank = 7" Reel 7280 = 13" Reel

Performance Characteristics

Item	Performance Characteristics
Operating Temperature	-55°C to 125°C
Rated Capacitance Range	0.1µF–1000µF @ 120 Hz/25°C
Capacitance Tolerance	K Tolerance (10%), M Tolerance (20%)
Rated Voltage Range	2.5V–50V
DF(120Hz)	Refer to Part Number Electrical Specification Table
ESR (100kHz)	Refer to Part Number Electrical Specification Table
Leakage Current	≤ 0.01CV (µA) at Rated Voltage after 5 minutes

Qualification – T491 Industrial Grade MnO₂ Series

Test	Condition	Characteristics					
Endurance	85°C @ Rated Voltage, 2,000 Hours 125°C @ 2/3 Rated Voltage, 2,000 Hours	ΔC/C	Within ± 10% of initial value				
		DF	Within initial limits				
		DCL	Within 1.25 x initial limit				
		ESR	Within initial limits				
Storage Life	125°C @ 0 Volts, 2,000 Hours	ΔC/C	Within ± 10% of initial value				
		DF	Within initial limits				
		DCL	Within 1.25 x initial limit				
		ESR	Within initial limits				
Thermal Shock	MIL-Std-202, Method 107, Condition B, mounted, -55°C to 125° C, 1000 cycles	ΔC/C	Within ± 5% of initial value				
		DF	Within initial limits				
		DCL	Within 1.25 x initial limit				
		ESR	Within initial limits				
Temperature Stability	Extreme temperature exposure at a succession of continuous steps at +25°C, -55°C, +25°C, +85°C, +125°C, +25°C.	+25°C	-55°C	+85°C	+125°C		
		ΔC/C	IL*	±10%	±10%	±20%	
		DF	IL	IL	1.5 x IL	1.5 x IL	
		DCL	IL	n/a	10 x IL	12 x IL	
		Surge Voltage	25°C and 85°C, 1.32 x Rated Voltage 1000 cycles (125°C, 1.2 x Rated Voltage).	ΔC/C	Within ± 5% of initial value		
				DF	Within initial limits		
DCL	Within initial limits						
ESR	Within initial limits						
Mechanical Shock/Vibration	MIL-STD-202, Meth. 213, Cond. I, 100G Peak MIL-STD-202, Meth. 204, Cond. D, 10Hz to 2000Hz, 20G Peak	ΔC/C	Within ±10% of initial value				
		DF	Within initial limits				
		DCL	Within initial limits				

*IL = Initial limit

Certification

KEMET's Internal Qualification Plan for this Tantalum series of capacitors follows AEC-Q200 guidelines. Standard catalog part types ordered without a specific automotive designator, i.e., suffix AUTO or four digit customer specific designator (C SPEC), are not considered KEMET Automotive Grade Tantalum capacitors.

Electrical Characteristics – T491 Industrial Grade MnO₂ Series

ESR vs. Frequency

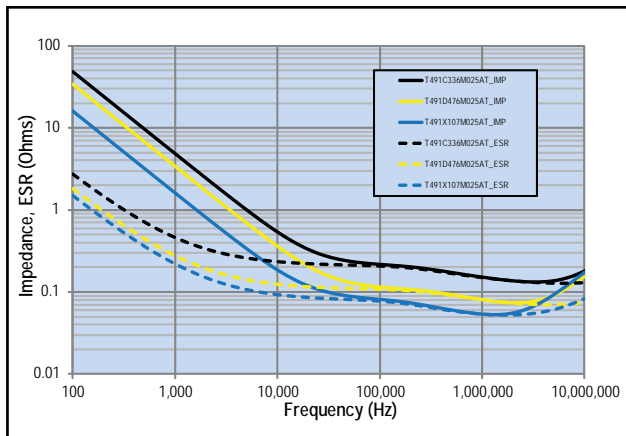

Capacitance vs. Frequency

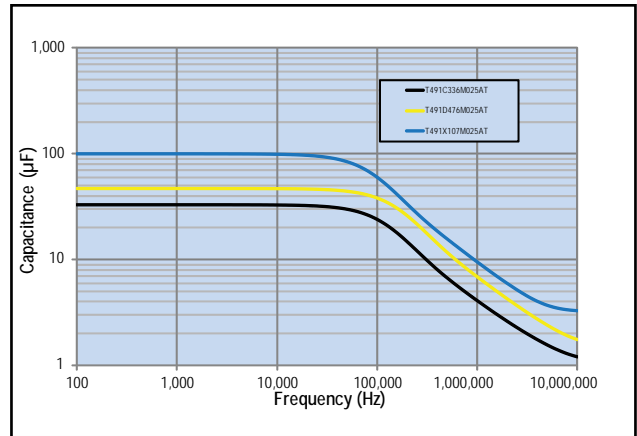

Dimensions – Millimeters (Inches)

Metric will govern

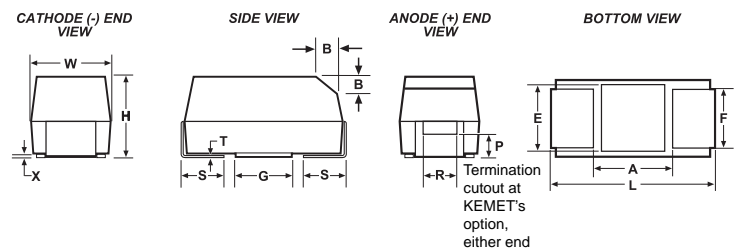

Case Size		Component												
KEMET	EIA	L*	W*	H*	F* ±0.1 ±(.004)	S* ±0.3 ±(.012)	B* ±0.15 (Ref) ±.006	X (Ref)	P (Ref)	R (Ref)	T (Ref)	A (Min)	G (Ref)	E (Ref)
A	3216-18	3.2 ± 0.2 (.126 ± .008)	1.6 ± 0.2 (.063 ± .008)	1.6 ± 0.2 (.063 ± .008)	1.2 (.047)	0.8 (.031)	0.4 (.016)	0.10 ± 0.10 (.004 ± .004)	0.4 (.016)	0.4 (.016)	0.13 (.005)	1.4 (.055)	1.1 (.043)	1.3 (.051)
B	3528-21	3.5 ± 0.2 (.138 ± .008)	2.8 ± 0.2 (.110 ± .008)	1.9 ± 0.2 (.075 ± .008)	2.2 (.087)	0.8 (.031)	0.4 (.016)	0.10 ± 0.10 (.004 ± .004)	0.5 (.020)	1.0 (.039)	0.13 (.005)	2.1 (.083)	1.8 (.071)	2.2 (.087)
C	6032-28	6.0 ± 0.3 (.236 ± .03)	3.2 ± 0.3 (.126 ± .012)	2.5 ± 0.3 (.098 ± .012)	2.2 (.087)	1.3 (.051)	0.5 (.020)	0.10 ± 0.10 (.004 ± .004)	0.9 (.035)	1.0 (.039)	0.13 (.005)	3.1 (.122)	2.8 (.110)	2.4 (.094)
D	7343-31	7.3 ± 0.3 (.287 ± .012)	4.3 ± 0.3 (.169 ± .012)	2.8 ± 0.3 (.110 ± .012)	2.4 (.094)	1.3 (.051)	0.5 (.020)	0.10 ± 0.10 (.004 ± .004)	0.9 (.035)	1.0 (.039)	0.13 (.005)	3.8 (.150)	3.5 (.138)	3.5 (.138)
X	7343-43	7.3 ± 0.3 (.287 ± .012)	4.3 ± 0.3 (.169 ± .012)	4.0 ± 0.3 (.157 ± .012)	2.4 (.094)	1.3 (.051)	0.5 (.020)	0.10 ± 0.10 (.004 ± .004)	1.7 (.067)	1.0 (.039)	0.13 (.005)	3.8 (.150)	3.5 (.138)	3.5 (.138)
E	7260-38	7.3 ± 0.3 (.287 ± .012)	6.0 ± 0.3 (.236 ± .012)	3.6 ± 0.2 (.142 ± .008)	4.1 (.161)	1.3 (.051)	0.5 (.020)	0.10 ± 0.10 (.004 ± .004)	0.9 (.035)	1.0 (.039)	0.13 (.005)	0.13 (.005)	3.5 (.138)	3.5 (.138)
R	2012-12	2.0 ± 0.2 (.079 ± .008)	1.3 ± 0.2 (.051 ± .008)	1.2 (.047)	0.9 (.035)	0.5 (.020)	n/a	0.05 (.002)	n/a	n/a	0.13 (.005)	0.8 (.031)	0.5 (.020)	0.8 (.031)
S	3216-12	3.2 ± 0.2 (.126 ± .008)	1.6 ± 0.2 (.063 ± .008)	1.2 (.047)	1.2 (.047)	0.8 (.031)	n/a	0.05 (.002)	n/a	n/a	0.13 (.005)	1.4 (.055)	1.1 (.043)	1.3 (.051)
T	3528-12	3.5 ± 0.2 (.138 ± .008)	2.8 ± 0.2 (.110 ± .008)	1.2 (.047)	2.2 (.087)	0.8 (.031)	n/a	0.05 (.002)	n/a	n/a	0.13 (.005)	2.1 (.083)	1.8 (.071)	2.2 (.087)
U	6032-15	6.0 ± 0.3 (.236 ± .012)	3.2 ± 0.2 (.110 ± .008)	3.2 ± 0.2	2.2 (.087)	1.3 (.051)	n/a	0.05 (.002)	n/a	n/a	0.13 (.005)	3.1 (.122)	2.8 (.110)	2.4 (.094)
V	7343-20	7.3 ± 0.3 (.287 ± .012)	4.3 ± 0.3 (.169 ± .012)	2.0 (.079)	2.4 (.094)	1.3 (.051)	n/a	0.05 (.002)	n/a	n/a	0.13 (.005)	3.8 (.150)	3.5 (.138)	3.5 (.138)

Notes: (Ref) – Dimensions provided for reference only. No dimensions are provided for B, P or R because low profile cases do not have a bevel or a notch.

* MIL-C-55365/8 specified dimensions

Table 1 – T491 Industrial Grade MnO₂ Series, Ratings & Part Number Reference

Rated Voltage	Rated Cap	Case Code/ Case Size	KEMET Part Number	DC Leakage		DF	ESR	Maximum Allowable Ripple Current			Moisture Sensitivity
				μAmps +20°C	+20°C 120Hz			+20°C 100kHz	+25°C 100kHz	+85°C 100kHz	
85°C	120Hz	KEMET/EIA	(See below for part options)	max/5min	% Max	Ohms	mAmps	mAmps	mAmps	Temp≤260°C	
VDC	μF			J-STD-020D							
2.5	100	T/3528-12	T491T107(1)2R5A(2)	2.5	24.0	3.9	134	121	54	1	
2.5	220	D/7343-31	T491D227(1)2R5A(2)	5.5	8.0	0.3	707	636	283	1	
3	33	A/3216-18	T491A336(1)003A(2)	1.0	6.0	4.0	137	123	55	1	
4	3.3	A/3216-18	T491A335(1)004A(2)	0.1	6.0	8.0	97	87	39	1	
4	4.7	A/3216-18	T491A475(1)004A(2)	0.2	6.0	8.0	97	87	39	1	
4	6.8	A/3216-18	T491A685(1)004A(2)	0.3	6.0	6.0	112	101	45	1	
4	6.8	S/3216-12	T491S685(1)004A(2)	0.3	6.0	15.0	63	57	25	1	
4	10	B/3528-21	T491B106(1)004A(2)	0.4	6.0	3.5	156	140	62	1	
4	10	A/3216-18	T491A106(1)004A(2)	0.4	6.0	6.0	112	101	45	1	
4	10	S/3216-12	T491S106(1)004A(2)	0.4	6.0	15.0	63	57	25	1	
4	10	R/2012-12	T491R106(1)004A(2)	0.4	8.0	10.0	50	45	20	1	
4	15	B/3528-21	T491B156(1)004A(2)	0.6	6.0	3.5	156	140	62	1	
4	15	A/3216-18	T491A156(1)004A(2)	0.6	6.0	4.0	137	123	55	1	
4	15	T/3528-12	T491T156(1)004A(2)	0.6	6.0	5.0	118	106	47	1	
4	15	S/3216-12	T491S156(1)004A(2)	0.6	10.0	15.0	63	57	25	1	
4	22	C/6032-28	T491C226(1)004A(2)	0.9	6.0	1.8	247	222	99	1	
4	22	B/3528-21	T491B226(1)004A(2)	0.9	6.0	3.5	156	140	62	1	
4	22	A/3216-18	T491A226(1)004A(2)	0.9	6.0	4.0	137	123	55	1	
4	22	T/3528-12	T491T226(1)004A(2)	0.9	6.0	5.0	118	106	47	1	
4	22	S/3216-12	T491S226(1)004A(2)	0.9	10.0	10.0	77	69	31	1	
4	33	C/6032-28	T491C336(1)004A(2)	1.3	6.0	1.8	247	222	99	1	
4	33	U/6032-15	T491U336(1)004A(2)	1.3	6.0	1.8	224	202	90	1	
4	33	B/3528-21	T491B336(1)004A(2)	1.3	6.0	3.5	156	140	62	1	
4	33	A/3216-18	T491A336(1)004A(2)	1.3	6.0	4.0	137	123	55	1	
4	33	T/3528-12	T491T336(1)004A(2)	1.3	8.0	5.0	118	106	47	1	
4	47	C/6032-28	T491C476(1)004A(2)	1.9	6.0	1.8	247	222	99	1	
4	47	U/6032-15	T491U476(1)004A(2)	1.9	6.0	1.8	224	202	90	1	
4	47	B/3528-21	T491B476(1)004A(2)	1.9	6.0	3.0	168	151	67	1	
4	47	A/3216-18	T491A476(M)004A(2)	1.9	12.0	2.5	173	156	69	1	
4	47	T/3528-12	T491T476(M)004A(2)	1.9	12.0	6.0	108	97	43	1	
4	68	D/7343-31	T491D686(1)004A(2)	2.7	6.0	0.8	433	390	173	1	
4	68	C/6032-28	T491C686(1)004A(2)	2.7	6.0	1.6	262	236	105	1	
4	68	U/6032-15	T491U686(1)004A(2)	2.7	6.0	1.8	224	202	90	1	
4	68	B/3528-21	T491B686(1)004A(2)	2.7	6.0	3.5	156	140	62	1	
4	68	A/3216-18	T491A686(1)004A(2)	2.7	30.0	4.0	137	123	55	1	
4	100	D/7343-31	T491D107(1)004A(2)	4.0	8.0	0.8	433	390	173	1	
4	100	C/6032-28	T491C107(1)004A(2)	4.0	8.0	1.2	303	273	121	1	
4	100	U/6032-15	T491U107(1)004A(2)	4.0	10.0	1.8	224	202	90	1	
4	100	B/3528-21	T491B107(M)004A(2)	4.0	8.0	0.9	307	276	123	1	
4	100	A/3216-18	T491A107(M)004A(2)	4.0	30.0	4.0	137	123	55	1	
4	100	T/3528-12	T491T107(M)004A(2)	4.0	30.0	5.0	118	106	47	1	
4	150	D/7343-31	T491D157(1)004A(2)	6.0	8.0	0.8	433	390	173	1	
4	150	U/6032-15	T491U157(1)004AT	6.0	8.0	1.3	263	237	105	1	
4	150	V/7343-20	T491V157(1)004A(2)	6.0	8.0	0.7	423	381	169	1	
4	150	C/6032-28	T491C157(1)004A(2)	6.0	8.0	1.2	303	273	121	1	
4	150	B/3528-21	T491B157(M)004A(2)	6.0	12.0	2.0	206	185	82	1	
VDC	μF	KEMET/EIA	(See below for part options)	max/5min	% Max	Ohms	mAmps	mAmps	mAmps	J-STD-020D	
85°C	120Hz			μAmps +20°C	+20°C 120Hz	+20°C 100kHz	+25°C 100kHz	+85°C 100kHz	+125°C 100kHz	Temp≤260°C	
Rated Voltage	Rated Cap	Case Code/ Case Size	KEMET Part Number	DC Leakage	DF	ESR	Maximum Allowable Ripple Current			Moisture Sensitivity	

1) To complete KEMET part number, insert M for ± 20% or K for ± 10%. Designates Capacitance tolerance.

2) To complete KEMET part number, insert T = 100% Matte Tin (Sn) Plated, G = Gold Plated, H = Standard Solder coated (SnPb 5% Pb minimum). Designates Termination Finish.

Refer to Ordering Information for additional detail.

Higher voltage ratings and tighter tolerance product including ESR may be substituted within the same size at KEMET's option. Voltage substitution will be marked with the higher voltage rating. Substitutions can include better than series.

Table 1 – T491 Industrial Grade MnO₂ Series, Ratings & Part Number Reference con't

Rated Voltage	Rated Cap	Case Code/ Case Size	KEMET Part Number	DC Leakage		DF	ESR	Maximum Allowable Ripple Current			Moisture Sensitivity
				μAmps +20°C	+20°C 120Hz			+20°C 100kHz	+25°C 100kHz	+85°C 100kHz	
VDC	μF	KEMET/EIA	(See below for part options)	max/5min	% Max	Ohms	mAmps	mAmps	mAmps	J-STD-020D	
4	220	V/7343-20	T491V227(1)004A(2)	8.8	8.0	0.7	423	381	169	1	
4	220	B/3528-21	T491B227(M)004A(2)	8.8	18.0	0.5	412	371	165	1	
4	220	C/6032-28	T491C227(1)004AT	8.8	15.0	1.2	303	273	121	1	
4	220	D/7343-31	T491D227(1)004AT	8.8	8.0	0.8	433	390	173	1	
4	220	W/7343-15	T491W227(1)004AT	8.8	8.0	0.8	474	427	190	1	
4	330	D/7343-31	T491D337(1)004A(2)	13.2	8.0	0.7	463	417	185	1	
4	330	V/7343-20	T491V337(1)004A(2)	13.2	12.0	0.7	423	381	169	1	
4	330	C/6032-28	T491C337(1)004A(2)	13.2	10.0	0.9	350	315	140	1	
4	330	X/7343-43	T491X337(1)004AT	13.2	8.0	0.8	454	409	182	1	
4	470	X/7343-43	T491X477(1)004A(2)	18.8	8.0	0.5	574	517	230	1	
4	470	D/7343-31	T491D477(1)004A(2)	18.8	8.0	0.8	433	390	173	1	
4	680	X/7343-43	T491X687(1)004A(2)	27.2	12.0	0.5	574	517	230	1	
4	680	D/7343-31	T491D687(1)004A(2)	27.2	12.0	0.5	548	493	219	1	
4	1000	X/7343-43	T491X108(1)004A(2)	40.0	12.0	0.5	574	517	230	1	
4	1000	E/7260-38	T491E108(M)004A(2)	40.0	15.0	0.2	1000	900	400	1	
6.3	2.2	R/2012-12	T491R225(1)006A(2)	0.1	6.0	25.0	32	29	13	1	
6.3	2.2	A/3216-18	T491A225(1)006A(2)	0.1	6.0	8.0	97	87	39	1	
6.3	3.3	A/3216-18	T491A335(1)006A(2)	0.2	6.0	8.0	97	87	39	1	
6.3	4.7	A/3216-18	T491A475(1)006A(2)	0.3	6.0	6.0	112	101	45	1	
6.3	4.7	S/3216-12	T491S475(1)006A(2)	0.3	6.0	15.0	63	57	25	1	
6.3	6.8	B/3528-21	T491B685(1)006A(2)	0.4	6.0	3.5	156	140	62	1	
6.3	6.8	A/3216-18	T491A685(1)006A(2)	0.4	6.0	6.0	112	101	45	1	
6.3	6.8	S/3216-12	T491S685(1)006A(2)	0.4	6.0	15.0	63	57	25	1	
6.3	6.8	R/2012-12	T491R685(1)006A(2)	0.4	8.0	15.0	41	37	16	1	
6.3	10	B/3528-21	T491B106(1)006A(2)	0.6	6.0	3.5	156	140	62	1	
6.3	10	A/3216-18	T491A106(1)006A(2)	0.6	6.0	4.0	137	123	55	1	
6.3	10	T/3528-12	T491T106(1)006A(2)	0.6	6.0	5.0	118	106	47	1	
6.3	10	S/3216-12	T491S106(1)006A(2)	0.6	10.0	15.0	63	57	25	1	
6.3	10	R/2012-12	T491R106(1)006A(2)	0.6	8.0	10.0	50	45	20	1	
6.3	15	C/6032-28	T491C156(1)006A(2)	0.9	6.0	1.8	247	222	99	1	
6.3	15	B/3528-21	T491B156(1)006A(2)	0.9	6.0	3.5	156	140	62	1	
6.3	15	A/3216-18	T491A156(1)006A(2)	0.9	6.0	3.5	146	131	58	1	
6.3	15	T/3528-12	T491T156(1)006A(2)	0.9	6.0	5.0	118	106	47	1	
6.3	15	S/3216-12	T491S156(1)006A(2)	0.9	15.0	10.0	77	69	31	1	
6.3	22	C/6032-28	T491C226(1)006A(2)	1.4	6.0	1.8	247	222	99	1	
6.3	22	U/6032-15	T491U226(1)006A(2)	1.4	6.0	1.8	224	202	90	1	
6.3	22	B/3528-21	T491B226(1)006A(2)	1.4	6.0	3.5	156	140	62	1	
6.3	22	A/3216-18	T491A226(1)006A(2)	1.4	6.0	4.0	137	123	55	1	
6.3	22	T/3528-12	T491T226(1)006A(2)	1.4	8.0	5.0	118	106	47	1	
6.3	33	C/6032-28	T491C336(1)006A(2)	2.1	6.0	1.8	247	222	99	1	
6.3	33	U/6032-15	T491U336(1)006A(2)	2.1	6.0	1.8	224	202	90	1	
6.3	33	B/3528-21	T491B336(1)006A(2)	2.1	6.0	3.0	168	151	67	1	
6.3	33	A/3216-18	T491A336(1)006A(2)	2.1	12.0	2.5	173	156	69	1	
6.3	33	T/3528-12	T491T336(1)006A(2)	2.1	12.0	6.0	108	97	43	1	
6.3	47	D/7343-31	T491D476(1)006A(2)	3.0	6.0	0.8	433	390	173	1	
6.3	47	C/6032-28	T491C476(1)006A(2)	3.0	6.0	1.6	262	236	105	1	
6.3	47	U/6032-15	T491U476(1)006A(2)	3.0	6.0	1.8	224	202	90	1	
VDC	μF	KEMET/EIA	(See below for part options)	max/5min	% Max	Ohms	mAmps	mAmps	mAmps	J-STD-020D	
85°C	120Hz			μAmps +20°C	+20°C 120Hz	+20°C 100kHz	+25°C 100kHz	+85°C 100kHz	+125°C 100kHz	Temp≤260°C	
Rated Voltage	Rated Cap	Case Code/ Case Size	KEMET Part Number	DC Leakage	DF	ESR	Maximum Allowable Ripple Current			Moisture Sensitivity	

1) To complete KEMET part number, insert M for ± 20% or K for ± 10%. Designates Capacitance tolerance.

2) To complete KEMET part number, insert T = 100% Matte Tin (Sn) Plated, G = Gold Plated, H = Standard Solder coated (SnPb 5% Pb minimum). Designates Termination Finish.

Refer to Ordering Information for additional detail.

Higher voltage ratings and tighter tolerance product including ESR may be substituted within the same size at KEMET's option. Voltage substitution will be marked with the higher voltage rating. Substitutions can include better than series.

Table 1 – T491 Industrial Grade MnO₂ Series, Ratings & Part Number Reference con't

Rated Voltage	Rated Cap	Case Code/ Case Size	KEMET Part Number	DC Leakage			ESR	Maximum Allowable Ripple Current			Moisture Sensitivity
				μAmps +20°C	+20°C 120Hz	+20°C 100kHz		+25°C 100kHz	+85°C 100kHz	+125°C 100kHz	
85°C	120Hz	KEMET/EIA	(See below for part options)	max/5min	% Max	Ohms	mAmps	mAmps	mAmps	Temp≤260°C	
VDC	μF			J-STD-020D							
6.3	47	V/7343-20	T491V476(1)006A(2)	3.0	6.0	0.7	423	381	169	1	
6.3	47	B/3528-21	T491B476(1)006A(2)	3.0	6.0	2.0	206	185	82	1	
6.3	47	A/3216-18	T491A476(M)006A(2)	3.0	12.0	3.5	146	131	58	1	
6.3	47	T/3528-12	T491T476(1)006A(2)	3.0	24.0	4.4	126	113	50	1	
6.3	68	D/7343-31	T491D686(1)006A(2)	4.3	6.0	0.8	433	390	173	1	
6.3	68	C/6032-28	T491C686(1)006A(2)	4.3	6.0	1.2	303	273	121	1	
6.3	68	U/6032-15	T491U686(1)006A(2)	4.3	10.0	1.8	224	202	90	1	
6.3	68	V/7343-20	T491V686(1)006A(2)	4.3	6.0	0.7	423	381	169	1	
6.3	68	B/3528-21	T491B686(1)006A(2)	4.3	8.0	0.9	307	276	123	1	
6.3	68	A/3216-18	T491A686(1)006A(2)	4.3	30.0	4.0	137	123	55	1	
6.3	100	D/7343-31	T491D107(1)006A(2)	6.3	8.0	0.8	433	390	173	1	
6.3	100	V/7343-20	T491V107(1)006A(2)	6.3	8.0	0.7	423	381	169	1	
6.3	100	C/6032-28	T491C107(1)006A(2)	6.3	8.0	0.9	350	315	140	1	
6.3	100	M/3528-15	T491M107(1)006A(2)	6.3	20.0	1.0	346	311	138	1	
6.3	100	U/6032-15	T491U107(1)006A(2)	6.3	10.0	1.8	224	202	90	1	
6.3	100	B/3528-21	T491B107(1)006A(2)	6.3	15.0	3.0	168	151	67	1	
6.3	150	D/7343-31	T491D157(1)006A(2)	9.5	8.0	0.7	463	417	185	1	
6.3	150	C/6032-28	T491C157(1)006A(2)	9.5	8.0	1.2	303	273	121	1	
6.3	150	V/7343-20	T491V157(1)006A(2)	9.5	8.0	0.7	423	381	169	1	
6.3	150	U/6032-15	T491U157(1)006A(2)	9.5	8.0	0.6	387	348	155	1	
6.3	150	W/7343-15	T491W157(1)006A(2)	9.5	8.0	0.8	474	427	190	1	
6.3	220	X/7343-43	T491X227(1)006A(2)	13.9	8.0	0.7	486	437	194	1	
6.3	220	D/7343-31	T491D227(1)006A(2)	13.9	8.0	0.7	463	417	185	1	
6.3	220	C/6032-28	T491C227(M)006A(2)	13.9	10.0	1.2	303	273	121	1	
6.3	220	V/7343-20	T491V227(1)006A(2)	13.9	12.0	0.7	423	381	169	1	
6.3	220	W/7343-15	T491W227(1)006A(2)	13.9	8.0	0.8	474	427	190	1	
6.3	330	V/7343-20	T491V337(1)006A(2)	20.8	8.0	0.7	423	381	169	1	
6.3	330	X/7343-43	T491X337(1)006A(2)	20.8	8.0	0.4	642	578	257	1	
6.3	330	D/7343-31	T491D337(1)006A(2)	20.8	8.0	0.4	612	551	245	1	
6.3	330	E/7260-38	T491E337(1)006A(2)	20.8	8.0	0.5	632	569	253	1	
6.3	470	X/7343-43	T491X477(1)006A(2)	29.6	10.0	0.4	642	578	257	1	
6.3	470	D/7343-31	T491D477(M)006A(2)	29.6	12.0	0.4	612	551	245	1	
6.3	470	E/7260-38	T491E477(1)006A(2)	29.6	10.0	0.4	707	636	283	1	
6.3	680	X/7343-43	T491X687(1)006A(2)	42.8	15.0	0.6	524	472	210	1	
6.3	680	E/7260-38	T491E687(M)006A(2)	42.8	12.0	0.5	632	569	253	1	
6.3	1000	X/7343-43	T491X108(1)006A(2)	63.0	15.0	0.6	524	472	210	1	
10	1.5	A/3216-18	T491A155(1)010A(2)	0.2	6.0	8.0	97	87	39	1	
10	2.2	B/3528-21	T491B225(1)010A(2)	0.2	6.0	3.5	156	140	62	1	
10	2.2	A/3216-18	T491A225(1)010A(2)	0.2	6.0	8.0	97	87	39	1	
10	3.3	A/3216-18	T491A335(1)010A(2)	0.3	6.0	6.0	112	101	45	1	
10	3.3	S/3216-12	T491S335(1)010A(2)	0.3	6.0	15.0	63	57	25	1	
10	3.3	R/2012-12	T491R335(1)010A(2)	0.3	8.0	15.0	41	37	16	1	
10	4.7	B/3528-21	T491B475(1)010A(2)	0.5	6.0	3.5	156	140	62	1	
10	4.7	A/3216-18	T491A475(1)010A(2)	0.5	6.0	5.0	122	110	49	1	
10	4.7	S/3216-12	T491S475(1)010A(2)	0.5	6.0	15.0	63	57	25	1	
10	4.7	R/2012-12	T491R475(1)010A(2)	0.5	8.0	10.0	50	45	20	1	
10	6.8	B/3528-21	T491B685(1)010A(2)	0.7	6.0	3.5	156	140	62	1	
VDC	μF	KEMET/EIA	(See below for part options)	max/5min	% Max	Ohms	mAmps	mAmps	mAmps	J-STD-020D	
85°C	120Hz			μAmps +20°C	+20°C 120Hz	+20°C 100kHz	+25°C 100kHz	+85°C 100kHz	+125°C 100kHz	Temp≤260°C	
Rated Voltage	Rated Cap	Case Code/ Case Size	KEMET Part Number	DC Leakage	DF	ESR	Maximum Allowable Ripple Current			Moisture Sensitivity	

1) To complete KEMET part number, insert M for ± 20% or K for ± 10%. Designates Capacitance tolerance.

2) To complete KEMET part number, insert T = 100% Matte Tin (Sn) Plated, G = Gold Plated, H = Standard Solder coated (SnPb 5% Pb minimum). Designates Termination Finish.

Refer to Ordering Information for additional detail.

Higher voltage ratings and tighter tolerance product including ESR may be substituted within the same size at KEMET's option. Voltage substitution will be marked with the higher voltage rating. Substitutions can include better than series.

Table 1 – T491 Industrial Grade MnO₂ Series, Ratings & Part Number Reference con't

Rated Voltage	Rated Cap	Case Code/ Case Size	KEMET Part Number	DC Leakage			ESR	Maximum Allowable Ripple Current			Moisture Sensitivity
				μAmps +20°C	+20°C 120Hz	+20°C 100kHz		+25°C 100kHz	+85°C 100kHz	+125°C 100kHz	
85°C	120Hz	KEMET/EIA	(See below for part options)	max/5min	% Max	Ohms	mAmps	mAmps	mAmps	Temp≤260°C	
VDC	μF			J-STD-020D							
10	6.8	A/3216-18	T491A685(1)010A(2)	0.7	6.0	4.0	137	123	55	1	
10	6.8	T/3528-12	T491T685(1)010A(2)	0.7	6.0	5.0	118	106	47	1	
10	6.8	S/3216-12	T491S685(1)010A(2)	0.7	10.0	15.0	63	57	25	1	
10	10	C/6032-28	T491C106(1)010A(2)	1.0	6.0	1.8	247	222	99	1	
10	10	B/3528-21	T491B106(1)010A(2)	1.0	6.0	3.5	156	140	62	1	
10	10	A/3216-18	T491A106(1)010A(2)	1.0	6.0	4.0	137	123	55	1	
10	10	T/3528-12	T491T106(1)010A(2)	1.0	6.0	5.0	118	106	47	1	
10	10	S/3216-12	T491S106(1)010A(2)	1.0	10.0	15.0	63	57	25	1	
10	10	R/2012-12	T491R106(1)010A(2)	1.0	24.0	30.0	29	26	12	1	
10	15	C/6032-28	T491C156(1)010A(2)	1.5	6.0	1.8	247	222	99	1	
10	15	U/6032-15	T491U156(1)010A(2)	1.5	6.0	1.8	224	202	90	1	
10	15	B/3528-21	T491B156(1)010A(2)	1.5	6.0	2.8	174	157	70	1	
10	15	A/3216-18	T491A156(1)010A(2)	1.5	8.0	6.0	112	101	45	1	
10	15	T/3528-12	T491T156(1)010A(2)	1.5	8.0	5.0	118	106	47	1	
10	22	C/6032-28	T491C226(1)010A(2)	2.2	6.0	1.8	247	222	99	1	
10	22	U/6032-15	T491U226(1)010A(2)	2.2	6.0	1.8	224	202	90	1	
10	22	B/3528-21	T491B226(1)010A(2)	2.2	6.0	2.4	188	169	75	1	
10	22	A/3216-18	T491A226(M)010A(2)	2.2	10.0	6.0	112	101	45	1	
10	22	T/3528-12	T491T226(1)010A(2)	2.2	12.0	8.0	94	85	38	1	
10	33	D/7343-31	T491D336(1)010A(2)	3.3	6.0	0.8	433	390	173	1	
10	33	V/7343-20	T491V336(1)010A(2)	3.3	6.0	0.7	423	381	169	1	
10	33	C/6032-28	T491C336(1)010A(2)	3.3	6.0	1.6	262	236	105	1	
10	33	U/6032-15	T491U336(1)010A(2)	3.3	6.0	1.8	224	202	90	1	
10	33	B/3528-21	T491B336(1)010A(2)	3.3	6.0	1.8	217	195	87	1	
10	33	T/3528-12	T491T336(1)010A(2)	3.3	24.0	5.0	118	106	47	1	
10	33	A/3216-18	T491A336(1)010A(2)	3.3	15.0	6.0	112	101	45	1	
10	47	D/7343-31	T491D476(1)010A(2)	4.7	6.0	0.8	433	390	173	1	
10	47	V/7343-20	T491V476(1)010A(2)	4.7	6.0	0.7	423	381	169	1	
10	47	C/6032-28	T491C476(1)010A(2)	4.7	6.0	1.2	303	273	121	1	
10	47	U/6032-15	T491U476(1)010A(2)	4.7	10.0	2.2	202	182	81	1	
10	47	B/3528-21	T491B476(1)010A(2)	4.7	8.0	1.0	292	263	117	1	
10	68	D/7343-31	T491D686(1)010A(2)	6.8	6.0	0.8	433	390	173	1	
10	68	V/7343-20	T491V686(1)010A(2)	6.8	6.0	0.7	423	381	169	1	
10	68	C/6032-28	T491C686(1)010A(2)	6.8	6.0	1.2	303	273	121	1	
10	68	W/7343-15	T491W686(1)010AT	6.8	6.0	1.2	387	348	155	1	
10	68	U/6032-15	T491U686(1)010A(2)	6.8	10.0	1.8	224	202	90	1	
10	68	B/3528-21	T491B686(M)010A(2)	6.8	10.0	3.0	168	151	67	1	
10	100	D/7343-31	T491D107(1)010A(2)	10.0	8.0	0.7	463	417	185	1	
10	100	U/6032-15	T491U107(1)010AT	10.0	8.0	0.7	359	323	144	1	
10	100	W/7343-15	T491W107(1)010AT	10.0	8.0	0.8	474	427	190	1	
10	100	C/6032-28	T491C107(1)010A(2)	10.0	8.0	1.2	303	273	121	1	
10	100	V/7343-20	T491V107(1)010A(2)	10.0	8.0	0.7	423	381	169	1	
10	150	X/7343-43	T491X157(1)010A(2)	15.0	8.0	0.7	486	437	194	1	
10	150	D/7343-31	T491D157(1)010A(2)	15.0	8.0	0.7	463	417	185	1	
10	150	C/6032-28	T491C157(1)010A(2)	15.0	10.0	0.9	350	315	140	1	
10	150	V/7343-20	T491V157(1)010A(2)	15.0	8.0	0.7	423	381	169	1	
10	220	X/7343-43	T491X227(1)010A(2)	22.0	8.0	0.5	574	517	230	1	
10	220	D/7343-31	T491D227(1)010A(2)	22.0	8.0	0.5	548	493	219	1	
VDC	μF	KEMET/EIA	(See below for part options)	max/5min	% Max	Ohms	mAmps	mAmps	mAmps	J-STD-020D	
85°C	120Hz			μAmps +20°C	+20°C 120Hz	+20°C 100kHz	+25°C 100kHz	+85°C 100kHz	+125°C 100kHz	Temp≤260°C	
Rated Voltage	Rated Cap	Case Code/ Case Size	KEMET Part Number	DC Leakage	DF	ESR	Maximum Allowable Ripple Current			Moisture Sensitivity	

1) To complete KEMET part number, insert M for ± 20% or K for ± 10%. Designates Capacitance tolerance.

2) To complete KEMET part number, insert T = 100% Matte Tin (Sn) Plated, G = Gold Plated, H = Standard Solder coated (SnPb 5% Pb minimum). Designates Termination Finish.

Refer to Ordering Information for additional detail.

Higher voltage ratings and tighter tolerance product including ESR may be substituted within the same size at KEMET's option. Voltage substitution will be marked with the higher voltage rating. Substitutions can include better than series.

Table 1 – T491 Industrial Grade MnO₂ Series, Ratings & Part Number Reference con't

Rated Voltage	Rated Cap	Case Code/ Case Size	KEMET Part Number	DC Leakage		DF	ESR	Maximum Allowable Ripple Current			Moisture Sensitivity
				μAmps +20°C	+20°C 120Hz			+20°C 100kHz	+25°C 100kHz	+85°C 100kHz	
85°C	120Hz	KEMET/EIA	(See below for part options)	max/5min	% Max	Ohms	mAmps	mAmps	mAmps	Temp≤260°C	
VDC	μF			J-STD-020D							
10	330	D/7343-31	T491D337(M)010A(2)	33.0	10.0	0.5	548	493	219	1	
10	330	X/7343-43	T491X337(1)010A(2)	33.0	10.0	0.5	574	517	230	1	
10	330	E/7260-38	T491E337(1)010A(2)	33.0	10.0	0.5	632	569	253	1	
10	470	X/7343-43	T491X477(M)010A(2)	47.0	10.0	0.2	908	817	363	1	
10	470	E/7260-38	T491E477(M)010A(2)	47.0	12.0	0.5	632	569	253	1	
16	1	A/3216-18	T491A105(1)016A(2)	0.2	4.0	10.0	87	78	35	1	
16	1.5	A/3216-18	T491A155(1)016A(2)	0.2	6.0	8.0	97	87	39	1	
16	2.2	A/3216-18	T491A225(1)016A(2)	0.4	6.0	6.0	112	101	45	1	
16	2.2	S/3216-12	T491S225(1)016A(2)	0.4	6.0	15.0	63	57	25	1	
16	2.2	R/2012-12	T491R225(1)016A(2)	0.4	8.0	25.0	32	29	13	1	
16	3.3	B/3528-21	T491B335(1)016A(2)	0.5	6.0	3.5	156	140	62	1	
16	3.3	A/3216-18	T491A335(1)016A(2)	0.5	6.0	5.0	122	110	49	1	
16	4.7	C/6032-28	T491C475(1)016A(2)	0.8	6.0	2.4	214	193	86	1	
16	4.7	B/3528-21	T491B475(1)016A(2)	0.8	6.0	3.5	156	140	62	1	
16	4.7	A/3216-18	T491A475(1)016A(2)	0.8	6.0	4.0	137	123	55	1	
16	4.7	T/3528-12	T491T475(1)016A(2)	0.8	6.0	5.0	118	106	47	1	
16	6.8	C/6032-28	T491C685(1)016A(2)	1.1	6.0	1.9	241	217	96	1	
16	6.8	B/3528-21	T491B685(1)016A(2)	1.1	6.0	2.5	184	166	74	1	
16	6.8	A/3216-18	T491A685(1)016A(2)	1.1	6.0	3.5	146	131	58	1	
16	10	C/6032-28	T491C106(1)016A(2)	1.6	6.0	1.8	247	222	99	1	
16	10	U/6032-15	T491U106(1)016A(2)	1.6	6.0	1.8	224	202	90	1	
16	10	B/3528-21	T491B106(1)016A(2)	1.6	6.0	2.8	174	157	70	1	
16	10	A/3216-18	T491A106(1)016A(2)	1.6	8.0	7.0	104	94	42	1	
16	10	T/3528-12	T491T106(1)016A(2)	1.6	8.0	8.0	94	85	38	1	
16	15	C/6032-28	T491C156(1)016A(2)	2.4	6.0	1.8	247	222	99	1	
16	15	U/6032-15	T491U156(1)016A(2)	2.4	6.0	1.8	224	202	90	1	
16	15	B/3528-21	T491B156(1)016A(2)	2.4	6.0	2.5	184	166	74	1	
16	15	A/3216-18	T491A156(1)016A(2)	2.4	8.0	3.5	146	131	58	1	
16	22	D/7343-31	T491D226(1)016A(2)	3.5	6.0	0.8	433	390	173	1	
16	22	C/6032-28	T491C226(1)016A(2)	3.5	6.0	1.6	262	236	105	1	
16	22	U/6032-15	T491U226(1)016A(2)	3.5	10.0	3.0	173	156	69	1	
16	22	B/3528-21	T491B226(1)016A(2)	3.5	6.0	2.2	197	177	79	1	
16	33	D/7343-31	T491D336(1)016A(2)	5.3	6.0	0.8	433	390	173	1	
16	33	C/6032-28	T491C336(1)016A(2)	5.3	6.0	1.2	303	273	121	1	
16	33	U/6032-15	T491U336(1)016A(2)	5.3	12.0	3.0	173	156	69	1	
16	33	B/3528-21	T491B336(1)016A(2)	5.3	8.0	2.1	201	181	80	1	
16	47	D/7343-31	T491D476(1)016A(2)	7.5	6.0	0.8	433	390	173	1	
16	47	V/7343-20	T491V476(1)016A(2)	7.5	6.0	0.7	423	381	169	1	
16	47	C/6032-28	T491C476(1)016A(2)	7.5	6.0	1.2	303	273	121	1	
16	68	V/7343-20	T491V686(1)016A(2)	10.9	6.0	0.7	423	381	169	1	
16	68	C/6032-28	T491C686(1)016AT	10.9	6.0	1.2	303	273	121	1	
16	68	W/7343-15	T491W686(1)016AT	10.9	6.0	0.8	474	427	190	1	
16	68	D/7343-31	T491D686(1)016A(2)	10.9	6.0	0.7	463	417	185	1	
16	68	C/6032-28	T491C686(1)016A(2)	10.9	12.0	1.2	303	273	121	1	
16	100	X/7343-43	T491X107(1)016A(2)	16.0	8.0	0.7	486	437	194	1	
16	100	C/6032-28	T491C107(1)016AT	16.0	10.0	1.0	332	299	133	1	
16	100	V/7343-20	T491V107(1)016A(2)	16.0	12.0	0.7	423	381	169	1	
VDC	μF	KEMET/EIA	(See below for part options)	max/5min	% Max	Ohms	mAmps	mAmps	mAmps	J-STD-020D	
85°C	120Hz			μAmps +20°C	+20°C 120Hz	+20°C 100kHz	+25°C 100kHz	+85°C 100kHz	+125°C 100kHz	Temp≤260°C	
Rated Voltage	Rated Cap	Case Code/ Case Size	KEMET Part Number	DC Leakage	DF	ESR	Maximum Allowable Ripple Current			Moisture Sensitivity	

1) To complete KEMET part number, insert M for ± 20% or K for ± 10%. Designates Capacitance tolerance.

2) To complete KEMET part number, insert T = 100% Matte Tin (Sn) Plated, G = Gold Plated, H = Standard Solder coated (SnPb 5% Pb minimum). Designates Termination Finish.

Refer to Ordering Information for additional detail.

Higher voltage ratings and tighter tolerance product including ESR may be substituted within the same size at KEMET's option. Voltage substitution will be marked with the higher voltage rating. Substitutions can include better than series.

Table 1 – T491 Industrial Grade MnO₂ Series, Ratings & Part Number Reference con't

Rated Voltage	Rated Cap	Case Code/ Case Size	KEMET Part Number	DC Leakage		DF	ESR	Maximum Allowable Ripple Current			Moisture Sensitivity
				μAmps +20°C	+20°C 120Hz			+20°C 100kHz	+25°C 100kHz	+85°C 100kHz	
85°C	120Hz	KEMET/EIA	(See below for part options)	max/5min	% Max	Ohms	mAmps	mAmps	mAmps	Temp≤260°C	
VDC	μF			J-STD-020D							
16	100	D/7343-31	T491D107(1)016A(2)	16.0	8.0	0.7	463	417	185	1	
16	150	X/7343-43	T491X157(1)016A(2)	24.0	8.0	0.5	574	517	230	1	
16	150	D/7343-31	T491D157(1)016A(2)	24.0	12.0	0.7	463	417	185	1	
16	220	X/7343-43	T491X227(1)016A(2)	35.2	10.0	0.5	574	517	230	1	
16	220	D/7343-31	T491D227(1)016AT	35.2	15.0	0.9	408	367	163	1	
16	220	E/7260-38	T491E227(1)016A(2)	35.2	7.2	0.9	471	424	188	1	
20	0.47	R/2012-12	T491R474(1)020A(2)	0.1	4.0	35.0	27	24	11	1	
20	0.68	A/3216-18	T491A684(1)020A(2)	0.1	4.0	12.0	79	71	32	1	
20	1	A/3216-18	T491A105(1)020A(2)	0.2	4.0	9.0	91	82	36	1	
20	1	S/3216-12	T491S105(1)020A(2)	0.2	6.0	18.0	58	52	23	1	
20	1	R/2012-12	T491R105(1)020A(2)	0.2	6.0	20.0	35	32	14	1	
20	1.5	A/3216-18	T491A155(1)020A(2)	0.3	6.0	6.5	107	96	43	1	
20	1.5	S/3216-12	T491S155(1)020A(2)	0.3	6.0	15.0	63	57	25	1	
20	2.2	B/3528-21	T491B225(1)020A(2)	0.4	6.0	3.5	156	140	62	1	
20	2.2	A/3216-18	T491A225(1)020A(2)	0.4	0.6	7.0	104	94	42	1	
20	2.2	R/2012-12	T491R225(1)020A(2)	0.4	8.0	8.0	56	50	22	1	
20	3.3	B/3528-21	T491B335(1)020A(2)	0.7	6.0	3.0	168	151	67	1	
20	3.3	A/3216-18	T491A335(1)020A(2)	0.7	6.0	4.5	129	116	52	1	
20	3.3	T/3528-12	T491T335(1)020A(2)	0.7	6.0	5.0	118	106	47	1	
20	4.7	C/6032-28	T491C475(1)020A(2)	0.9	6.0	2.4	214	193	86	1	
20	4.7	B/3528-21	T491B475(1)020A(2)	0.9	6.0	3.0	168	151	67	1	
20	4.7	A/3216-18	T491A475(1)020A(2)	0.9	6.0	4.0	137	123	55	1	
20	6.8	C/6032-28	T491C685(1)020A(2)	1.4	6.0	1.9	241	217	96	1	
20	6.8	U/6032-15	T491U685(1)020A(2)	1.4	6.0	1.9	218	196	87	1	
20	6.8	B/3528-21	T491B685(1)020A(2)	1.4	6.0	2.5	184	166	74	1	
20	6.8	A/3216-18	T491A685(M)020A(2)	1.4	8.0	6.0	112	101	45	1	
20	10	C/6032-28	T491C106(1)020A(2)	2.0	6.0	1.8	247	222	99	1	
20	10	U/6032-15	T491U106(1)020A(2)	2.0	6.0	1.8	224	202	90	1	
20	10	B/3528-21	T491B106(1)020A(2)	2.0	6.0	2.1	201	181	80	1	
20	10	A/3216-18	T491A106(M)020A(2)	2.0	10.0	5.0	122	110	49	1	
20	15	D/7343-31	T491D156(1)020A(2)	3.0	6.0	1.0	387	348	155	1	
20	15	B/3528-21	T491B156(1)020AT	3.0	6.0	2.5	184	166	74	1	
20	15	C/6032-28	T491C156(1)020A(2)	3.0	6.0	1.7	254	229	102	1	
20	22	D/7343-31	T491D226(1)020A(2)	4.4	6.0	0.8	433	390	173	1	
20	22	V/7343-20	T491V226(1)020A(2)	4.4	6.0	0.7	423	381	169	1	
20	22	C/6032-28	T491C226(1)020A(2)	4.4	6.0	1.2	303	273	121	1	
20	22	B/3528-21	T491B226(1)020A(2)	4.4	8.0	4.0	146	131	58	1	
20	33	D/7343-31	T491D336(1)020A(2)	6.6	6.0	0.8	433	390	173	1	
20	33	C/6032-28	T491C336(M)020A(2)	6.6	6.0	1.2	303	273	121	1	
20	33	V/7343-20	T491V336(1)020A(2)	6.6	8.0	0.7	423	381	169	1	
20	33	B/3528-21	T491B336(M)020A(2)	6.6	10.0	4.0	146	131	58	1	
20	47	C/6032-28	T491C476(M)020A(2)	9.4	10.0	0.9	350	315	140	1	
20	47	X/7343-43	T491X476(1)020AT	9.4	6.0	0.8	454	409	182	1	
20	47	D/7343-31	T491D476(1)020A(2)	9.4	6.0	0.7	463	417	185	1	
20	68	X/7343-43	T491X686(1)020A(2)	13.6	6.0	0.7	486	437	194	1	
20	68	D/7343-31	T491D686(1)020A(2)	13.6	8.0	0.7	463	417	185	1	
20	100	X/7343-43	T491X107(1)020A(2)	20.0	8.0	0.5	574	517	230	1	
VDC	μF	KEMET/EIA	(See below for part options)	max/5min	% Max	Ohms	mAmps	mAmps	mAmps	J-STD-020D	
85°C	120Hz			μAmps +20°C	+20°C 120Hz	+20°C 100kHz	+25°C 100kHz	+85°C 100kHz	+125°C 100kHz	Temp≤260°C	
Rated Voltage	Rated Cap	Case Code/ Case Size	KEMET Part Number	DC Leakage	DF	ESR	Maximum Allowable Ripple Current			Moisture Sensitivity	

1) To complete KEMET part number, insert M for ± 20% or K for ± 10%. Designates Capacitance tolerance.

2) To complete KEMET part number, insert T = 100% Matte Tin (Sn) Plated, G = Gold Plated, H = Standard Solder coated (SnPb 5% Pb minimum). Designates Termination Finish.

Refer to Ordering Information for additional detail.

Higher voltage ratings and tighter tolerance product including ESR may be substituted within the same size at KEMET's option. Voltage substitution will be marked with the higher voltage rating. Substitutions can include better than series.

Table 1 – T491 Industrial Grade MnO₂ Series, Ratings & Part Number Reference con't

Rated Voltage	Rated Cap	Case Code/ Case Size	KEMET Part Number	DC			Maximum Allowable Ripple Current			Moisture Sensitivity
				Leakage	DF	ESR	Ripple Current			
85°C	120Hz	KEMET/EIA	(See below for part options)	μAmps +20°C	+20°C 120Hz	+20°C 100kHz	+25°C 100kHz	+85°C 100kHz	+125°C 100kHz	Temp≤260°C
VDC	μF			max/5min	% Max	Ohms	mAmps	mAmps	mAmps	J-STD-020D
20	100	D/7343-31	T491D107(1)020A(2)	20.0	8.0	0.9	408	367	163	1
20	100	E/7260-38	T491E107(1)020A(2)	20.0	8.0	0.5	632	569	253	1
20	150	X/7343-43	T491X157(1)020A(2)	30.0	10.0	0.5	574	517	230	1
25	0.33	A/3216-18	T491A334(1)025A(2)	0.1	4.0	15.0	71	64	28	1
25	0.47	A/3216-18	T491A474(1)025A(2)	0.1	4.0	14.0	73	66	29	1
25	0.68	A/3216-18	T491A684(1)025A(2)	0.2	4.0	10.0	87	78	35	1
25	1	B/3528-21	T491B105(1)025A(2)	0.3	4.0	5.0	130	117	52	1
25	1	A/3216-18	T491A105(1)025A(2)	0.3	4.0	8.0	97	87	39	1
25	1	S/3216-12	T491S105(1)025A(2)	0.3	6.0	18.0	58	52	23	1
25	1.5	B/3528-21	T491B155(1)025A(2)	0.4	6.0	5.0	130	117	52	1
25	1.5	A/3216-18	T491A155(1)025A(2)	0.4	6.0	7.5	100	90	40	1
25	1.5	R/2012-12	T491R155(1)025A(2)	0.4	8.0	8.0	56	50	22	1
25	2.2	C/6032-28	T491C225(1)025A(2)	0.6	6.0	3.5	177	159	71	1
25	2.2	A/3216-18	T491A225(1)025A(2)	0.6	6.0	7.0	104	94	42	1
25	2.2	B/3528-21	T491B225(1)025A(2)	0.6	6.0	4.5	137	123	55	1
25	3.3	C/6032-28	T491C335(1)025A(2)	0.8	6.0	2.5	210	189	84	1
25	3.3	A/3216-18	T491A335(1)025A(2)	0.8	6.0	7.0	104	94	42	1
25	3.3	B/3528-21	T491B335(1)025A(2)	0.8	6.0	3.5	156	140	62	1
25	4.7	C/6032-28	T491C475(1)025A(2)	1.2	6.0	2.4	214	193	86	1
25	4.7	B/3528-21	T491B475(1)025A(2)	1.2	6.0	1.5	238	214	95	1
25	4.7	A/3216-18	T491A475(M)025A(2)	1.2	8.0	6.0	112	101	45	1
25	6.8	C/6032-28	T491C685(1)025A(2)	1.7	6.0	1.9	241	217	96	1
25	6.8	D/7343-31	T491D685(1)025A(2)	1.7	6.0	1.8	289	260	116	1
25	6.8	B/3528-21	T491B685(1)025A(2)	1.7	8.0	2.8	174	157	70	1
25	10	D/7343-31	T491D106(1)025A(2)	2.5	6.0	1.0	387	348	155	1
25	10	C/6032-28	T491C106(1)025A(2)	2.5	6.0	1.5	271	244	108	1
25	10	B/3528-21	T491B106(1)025A(2)	2.5	8.0	3.0	168	151	67	1
25	15	D/7343-31	T491D156(1)025A(2)	3.8	6.0	1.0	387	348	155	1
25	15	V/7343-20	T491V156(1)025A(2)	3.8	6.0	1.0	354	319	142	1
25	15	C/6032-28	T491C156(1)025A(2)	3.8	6.0	1.5	271	244	108	1
25	15	B/3528-21	T491B156(1)025A(2)	3.8	8.0	4.0	146	131	58	1
25	22	D/7343-31	T491D226(1)025A(2)	5.5	6.0	0.8	433	390	173	1
25	22	C/6032-28	T491C226(1)025A(2)	5.5	6.0	1.4	280	252	112	1
25	22	V/7343-20	T491V226(1)025A(2)	5.5	6.0	0.7	423	381	169	1
25	33	X/7343-43	T491X336(1)025A(2)	8.3	6.0	0.7	486	437	194	1
25	33	D/7343-31	T491D336(1)025A(2)	8.3	6.0	0.7	463	417	185	1
25	33	C/6032-28	T491C336(1)025A(2)	8.3	10.0	1.2	303	273	121	1
25	47	X/7343-43	T491X476(1)025A(2)	11.8	6.0	0.7	486	437	194	1
25	47	D/7343-31	T491D476(1)025A(2)	11.8	10.0	0.7	463	417	185	1
25	68	X/7343-43	T491X686(M)025A(2)	17.0	8.0	0.7	486	437	194	1
25	68	D/7343-31	T491D686(M)025A(2)	17.0	10.0	0.7	463	417	185	1
25	100	X/7343-43	T491X107(1)025A(2)	25.0	8.0	0.3	742	668	297	1
35	0.1	A/3216-18	T491A104(1)035A(2)	0.0	4.0	20.0	61	55	24	1
35	0.15	A/3216-18	T491A154(1)035A(2)	0.1	4.0	19.0	63	57	25	1
35	0.22	A/3216-18	T491A224(1)035A(2)	0.1	4.0	18.0	65	59	26	1
35	0.33	A/3216-18	T491A334(1)035A(2)	0.1	4.0	15.0	71	64	28	1
VDC	μF	KEMET/EIA	(See below for part options)	max/5min	% Max	Ohms	mAmps	mAmps	mAmps	J-STD-020D
85°C	120Hz			μAmps +20°C	+20°C 120Hz	+20°C 100kHz	+25°C 100kHz	+85°C 100kHz	+125°C 100kHz	Temp≤260°C
Rated Voltage	Rated Cap	Case Code/ Case Size	KEMET Part Number	DC Leakage	DF	ESR	Maximum Allowable Ripple Current			Moisture Sensitivity

1) To complete KEMET part number, insert M for ± 20% or K for ± 10%. Designates Capacitance tolerance.

2) To complete KEMET part number, insert T = 100% Matte Tin (Sn) Plated, G = Gold Plated, H = Standard Solder coated (SnPb 5% Pb minimum). Designates Termination Finish.

Refer to Ordering Information for additional detail.

Higher voltage ratings and tighter tolerance product including ESR may be substituted within the same size at KEMET's option. Voltage substitution will be marked with the higher voltage rating. Substitutions can include better than series.

Table 1 – T491 Industrial Grade MnO₂ Series, Ratings & Part Number Reference con't

Rated Voltage	Rated Cap	Case Code/ Case Size	KEMET Part Number	DC Leakage		DF	ESR	Maximum Allowable Ripple Current			Moisture Sensitivity
				μAmps +20°C	+20°C 120Hz			+20°C 100kHz	+25°C 100kHz	+85°C 100kHz	
85°C	120Hz	KEMET/EIA	(See below for part options)	max/5min	% Max	Ohms	mAmps	mAmps	mAmps	Temp≤260°C	
VDC	μF			J-STD-020D							
35	0.47	B/3528-21	T491B474(1)035A(2)	0.2	4.0	8.0	103	93	41	1	
35	0.47	A/3216-18	T491A474(1)035A(2)	0.2	4.0	12.0	79	71	32	1	
35	0.68	B/3528-21	T491B684(1)035A(2)	0.2	4.0	6.5	114	103	46	1	
35	0.68	A/3216-18	T491A684(1)035A(2)	0.2	4.0	8.0	97	87	39	1	
35	1	B/3528-21	T491B105(1)035A(2)	0.4	4.0	5.0	130	117	52	1	
35	1	A/3216-18	T491A105(1)035A(2)	0.4	4.0	7.5	100	90	40	1	
35	1.5	C/6032-28	T491C155(1)035A(2)	0.5	6.0	4.5	156	140	62	1	
35	1.5	B/3528-21	T491B155(1)035A(2)	0.5	6.0	5.0	130	117	52	1	
35	2.2	C/6032-28	T491C225(1)035A(2)	0.8	6.0	3.5	177	159	71	1	
35	2.2	A/3216-18	T491A225(1)035AT	0.8	6.0	4.5	129	116	52	1	
35	2.2	B/3528-21	T491B225(1)035A(2)	0.8	6.0	4.0	146	131	58	1	
35	3.3	C/6032-28	T491C335(1)035A(2)	1.2	6.0	2.5	210	189	84	1	
35	3.3	B/3528-21	T491B335(1)035A(2)	1.2	6.0	3.5	156	140	62	1	
35	4.7	D/7343-31	T491D475(1)035A(2)	1.6	6.0	1.5	316	284	126	1	
35	4.7	B/3528-21	T491B475(1)035AT	1.6	6.0	3.1	166	149	66	1	
35	4.7	C/6032-28	T491C475(1)035A(2)	1.6	6.0	2.2	224	202	90	1	
35	6.8	D/7343-31	T491D685(1)035A(2)	2.4	6.0	1.3	340	306	136	1	
35	6.8	V/7343-20	T491V685(1)035AT	2.4	6.0	1.2	323	291	129	1	
35	6.8	C/6032-28	T491C685(1)035A(2)	2.4	6.0	1.8	247	222	99	1	
35	10	D/7343-31	T491D106(1)035A(2)	3.5	6.0	1.0	387	348	155	1	
35	10	C/6032-28	T491C106(M)035A(2)	3.5	6.0	1.6	262	236	105	1	
35	10	V/7343-20	T491V106(1)035A(2)	3.5	6.0	2.0	250	225	100	1	
35	15	X/7343-43	T491X156(1)035A(2)	5.3	6.0	0.9	428	385	171	1	
35	15	C/6032-28	T491C156(1)035AT	5.3	6.0	1.4	280	252	112	1	
35	15	D/7343-31	T491D156(1)035A(2)	5.3	6.0	0.8	433	390	173	1	
35	22	X/7343-43	T491X226(1)035A(2)	7.7	6.0	0.7	486	437	194	1	
35	22	D/7343-31	T491D226(1)035A(2)	7.7	6.0	0.7	463	417	185	1	
35	33	X/7343-43	T491X336(1)035A(2)	11.6	6.0	0.6	524	472	210	1	
35	47	X/7343-43	T491X476(1)035A(2)	16.5	8.0	0.6	524	472	210	1	
35	47	E/7260-38	T491E476(1)035A(2)	16.5	10.0	0.5	632	569	253	1	
50	0.1	A/3216-18	T491A104(1)050A(2)	0.1	4.0	20.0	61	55	24	1	
50	0.15	B/3528-21	T491B154(1)050A(2)	0.1	4.0	16.0	73	66	29	1	
50	0.15	A/3216-18	T491A154(1)050A(2)	0.1	4.0	15.0	71	64	28	1	
50	0.22	B/3528-21	T491B224(1)050A(2)	0.1	4.0	14.0	78	70	31	1	
50	0.22	A/3216-18	T491A224(1)050AT	0.1	4.0	18.0	65	59	26	1	
50	0.33	B/3528-21	T491B334(1)050A(2)	0.2	4.0	10.0	92	83	37	1	
50	0.47	C/6032-28	T491C474(1)050A(2)	0.2	4.0	8.0	117	105	47	1	
50	0.47	B/3528-21	T491B474(1)050A(2)	0.2	4.0	9.0	97	87	39	1	
50	0.68	C/6032-28	T491C684(1)050A(2)	0.3	4.0	7.0	125	113	50	1	
50	0.68	B/3528-21	T491B684(1)050A(2)	0.3	4.0	8.0	103	93	41	1	
50	1	C/6032-28	T491C105(1)050A(2)	0.5	4.0	5.5	141	127	56	1	
50	1	B/3528-21	T491B105(1)050A(2)	0.5	6.0	6.0	119	107	48	1	
50	1	V/7343-20	T491V105(1)050A(2)	0.5	4.0	6.0	144	130	58	1	
50	1.5	D/7343-31	T491D155(1)050A(2)	0.8	6.0	3.5	207	186	83	1	
50	1.5	C/6032-28	T491C155(1)050A(2)	0.8	6.0	4.5	156	140	62	1	
50	2.2	D/7343-31	T491D225(1)050A(2)	1.1	6.0	2.5	245	221	98	1	
50	2.2	C/6032-28	T491C225(1)050A(2)	1.1	6.0	3.0	191	172	76	1	
VDC	μF	KEMET/EIA	(See below for part options)	max/5min	% Max	Ohms	mAmps	mAmps	mAmps	J-STD-020D	
85°C	120Hz			μAmps +20°C	+20°C 120Hz	+20°C 100kHz	+25°C 100kHz	+85°C 100kHz	+125°C 100kHz	Temp≤260°C	
Rated Voltage	Rated Cap	Case Code/ Case Size	KEMET Part Number	DC Leakage	DF	ESR	Maximum Allowable Ripple Current			Moisture Sensitivity	

1) To complete KEMET part number, insert M for ± 20% or K for ± 10%. Designates Capacitance tolerance.

2) To complete KEMET part number, insert T = 100% Matte Tin (Sn) Plated, G = Gold Plated, H = Standard Solder coated (SnPb 5% Pb minimum). Designates Termination Finish.

Refer to Ordering Information for additional detail.

Higher voltage ratings and tighter tolerance product including ESR may be substituted within the same size at KEMET's option. Voltage substitution will be marked with the higher voltage rating. Substitutions can include better than series.

Table 1 – T491 Industrial Grade MnO₂ Series, Ratings & Part Number Reference con't

Rated Voltage	Rated Cap	Case Code/ Case Size	KEMET Part Number	DC Leakage	DF	ESR	Maximum Allowable Ripple Current			Moisture Sensitivity
				μ Amps +20°C	+20°C 120Hz	+20°C 100kHz	+25°C 100kHz	+85°C 100kHz	+125°C 100kHz	Temp \leq 260°C
VDC	μ F	KEMET/EIA	(See below for part options)	max/5min	% Max	Ohms	mAmps	mAmps	mAmps	J-STD-020D
50	3.3			C/6032-28	T491C335(1)050AT	1.7	6.0	2.5	210	189
50	3.3	D/7343-31	T491D335(1)050A(2)	1.7	6.0	2.0	274	247	110	1
50	4.7	D/7343-31	T491D475(1)050A(2)	2.4	6.0	1.4	327	294	131	1
50	6.8	X/7343-43	T491X685(1)050A(2)	3.4	6.0	1.0	406	365	162	1
50	6.8	D/7343-31	T491D685(1)050A(2)	3.4	6.0	1.0	387	348	155	1
50	10	X/7343-43	T491X106(M)050A(2)	5.0	6.0	0.7	486	437	194	1
50	10	D/7343-31	T491D106(1)050A(2)	5.0	6.0	0.8	433	390	173	1
50	15	X/7343-43	T491X156(1)050A(2)	7.5	8.0	0.7	486	437	194	1
50	22	X/7343-43	T491X226(1)050A(2)	11.0	10.0	0.6	524	472	210	1
VDC	μ F	KEMET/EIA	(See below for part options)	max/5min	% Max	Ohms	mAmps	mAmps	mAmps	J-STD-020D
85°C	120Hz			μ Amps +20°C	+20°C 120Hz	+20°C 100kHz	+25°C 100kHz	+85°C 100kHz	+125°C 100kHz	Temp \leq 260°C
Rated Voltage	Rated Cap	Case Code/ Case Size	KEMET Part Number	DC Leakage	DF	ESR	Maximum Allowable Ripple Current			Moisture Sensitivity

1) To complete KEMET part number, insert M for \pm 20% or K for \pm 10%. Designates Capacitance tolerance.

2) To complete KEMET part number, insert T = 100% Matte Tin (Sn) Plated, G = Gold Plated, H = Standard Solder coated (SnPb 5% Pb minimum). Designates Termination Finish.

Refer to Ordering Information for additional detail.

Higher voltage ratings and tighter tolerance product including ESR may be substituted within the same size at KEMET's option. Voltage substitution will be marked with the higher voltage rating. Substitutions can include better than series.

Capacitor Marking

C, D, X Case Sizes

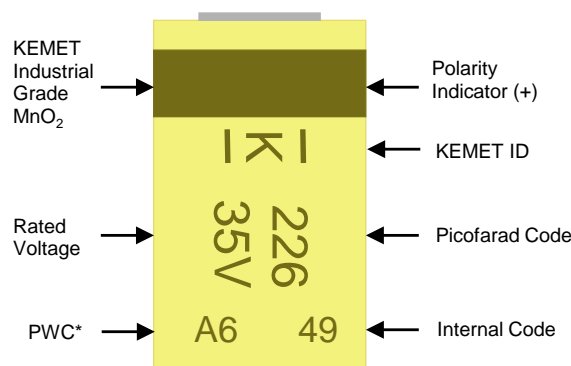
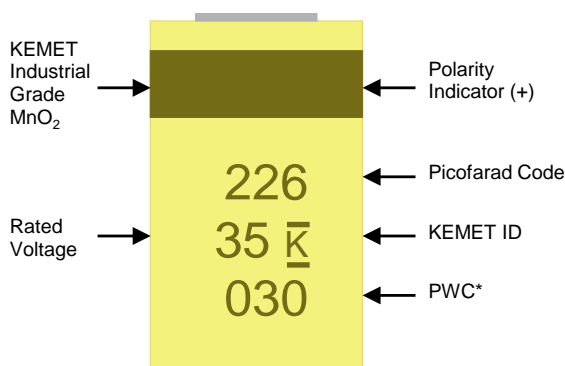

* 030 = 30th week of 2010

PWC*		
Year	Month	
V = 2008	1 = Jan	7 = Jul
W = 2008	2 = Feb	8 = Aug
X = 2009	3 = Mar	9 = Spt
A = 2010	4 = Apr	O = Oct
B = 2011	5 = May	N = Nov
C = 2012	6 = Jun	D = Dec

Storage

Tantalum chip capacitors should be stored in normal working environments. While the chips themselves are quite robust in other environments, solderability will be degraded by exposure to high temperatures, high humidity, corrosive atmospheres, and long term storage. In addition, packaging materials will be degraded by high temperature - reels may soften or warp, and tape peel force may increase. KEMET recommends that maximum storage temperature not exceed 40°C, and maximum storage humidity not exceed 60% relative humidity. In addition, temperature fluctuations should be minimized to avoid condensation on the parts, and atmospheres should be free of chlorine and sulphur bearing compounds. For optimized solderability, chip stock should be used promptly, preferably within three years of receipt.

Recommended Voltage Derating Guidelines

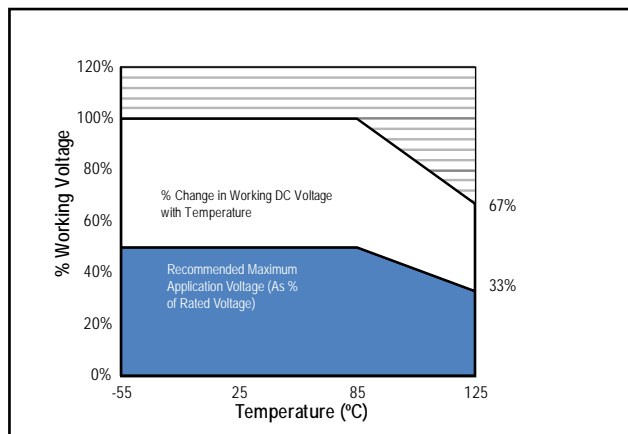

Ripple Current/Ripple Voltage

Case Code		Maximum Power Dissipation (Pmax) mWatts @ 25°C w/+20°C Rise
KEMET	EIA	
A	3216-18	75
B	3528-21	85
C	6032-28	110
D	7343-31	150
X	7343-43	165
E	7260-38	200
R	2012-12	25
S	3216-12	60
T	3528-12	70
U	6032-15	90
V	7343-20	125
T510X	7343-43	270
T510E	7260-38	285

Temperature Compensation Multipliers for Maximum Power Dissipation		
≤25°C	85°C	125°C
1.00	0.90	0.40

T = Environmental Temperature

Using the P max of the device, the maximum allowable rms ripple current or voltage may be determined.

$$I(max) = \sqrt{P_{max}/R}$$

$$E(max) = \sqrt{P_{max} \cdot R}$$

I = rms ripple current (amperes)

E = rms ripple voltage (volts)

*P*_{max} = maximum power dissipation (watts)

R = ESR at specified frequency (ohms)

Reverse Voltage

Solid tantalum capacitors are polar devices and may be permanently damaged or destroyed if connected with the wrong polarity. The positive terminal is identified on the capacitor body by a stripe plus in some cases a beveled edge. A small degree of transient reverse voltage is permissible for short periods per the table. The capacitors should not be operated continuously in reverse mode, even within these limits.

Temperature	Permissible Transient Reverse Voltage
25°C	15% of Rated Voltage
85°C	5% of Rated Voltage
125°C	1% of Rated Voltage

Table 2 – Land Dimensions/Courtyard

KEMET	Metric Size Code	Density Level A: Maximum (Most) Land Protrusion (mm)					Density Level B: Median (Nominal) Land Protrusion (mm)					Density Level C: Minimum (Least) Land Protrusion (mm)				
		Case	EIA	X	Y	C	V1	V2	X	Y	C	V1	V2	X	Y	C
A	3216-18	1.35	2.15	1.45	6.10	2.80	1.25	1.75	1.35	5.00	2.30	1.15	1.35	1.25	4.10	2.00
B	3528-21	2.35	2.15	1.45	6.10	4.00	2.25	1.75	1.35	5.00	3.50	2.15	1.35	1.25	4.10	3.20
C	6032-28	2.35	2.65	2.60	8.90	4.40	2.25	2.25	2.50	7.80	3.90	2.15	1.85	2.40	6.90	3.60
D	7343-31	2.55	3.75	2.70	10.20	5.50	2.45	3.35	2.60	9.10	5.00	2.35	2.95	2.50	8.20	4.70
E ¹	7260-38	4.25	2.65	3.20	10.10	7.20	4.15	2.25	3.30	9.40	6.70	4.05	1.85	3.00	8.10	6.40
R	2012-12	1.05	1.80	1.00	4.80	2.40	0.95	1.45	0.90	3.80	1.90	0.85	1.05	0.80	2.90	1.60
S ²	3216-12	1.35	2.15	1.45	6.10	2.80	1.25	1.75	1.35	5.00	2.30	1.15	1.35	1.25	4.10	2.00
T	3528-12	2.35	2.15	1.45	6.10	4.00	2.25	1.75	1.35	5.00	3.50	2.15	1.35	1.25	4.10	3.20
U	6032-15	2.55	3.75	2.70	10.20	5.50	2.45	3.35	2.60	9.10	5.00	2.35	2.95	2.50	8.20	4.70
V	7343-20	2.55	3.75	2.70	10.20	5.50	2.45	3.35	2.60	9.10	5.00	2.35	2.95	2.50	8.20	4.70
X ¹	7343-43	2.55	3.75	2.70	10.20	5.50	2.45	3.35	2.60	9.10	5.00	2.35	2.95	2.50	8.20	4.70

Density Level A: For low-density product applications. Recommended for wave solder applications and provides a wider process window for reflow solder processes.

Density Level B: For products with a moderate level of component density. Provides a robust solder attachment condition for reflow solder processes.

Density Level C: For high component density product applications. Before adapting the minimum land pattern variations the user should perform qualification testing based on the conditions outlined in IPC standard 7351 (IPC-7351).

¹ Height of these chips may create problems in wave soldering.

² Land pattern geometry is too small for silkscreen outline.

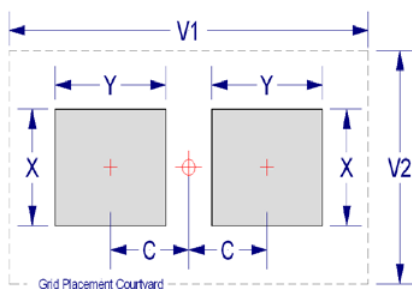

Soldering Process

KEMET's families of surface mount capacitors are compatible with wave (single or dual), convection, IR or vapor phase reflow techniques. Preheating of these components is recommended to avoid extreme thermal stress. KEMET's recommended profile conditions for convection and IR reflow reflect the profile conditions of the IPC/J-STD-020D standard for moisture sensitivity testing. The devices can safely withstand a maximum of three reflow passes at these conditions.

Note that although the X/7343-43 case size can withstand wave soldering, the tall profile (4.3 mm maximum) dictates care in wave process development.

Hand soldering should be performed with care due to the difficulty in process control. If performed, care should be taken to avoid contact of the soldering iron to the molded case. The iron should be used to heat the solder pad, applying solder between the pad and the termination, until reflow occurs. Once reflow occurs, the iron should be removed immediately. "Wiping" the edges of a chip and heating the top surface is not recommended.

During typical reflow operations, a slight darkening of the gold-colored epoxy may be observed. This slight darkening is normal and is not harmful to the product. Marking permanency is not affected by this change.

Profile Feature	SnPb Assembly	Pb-Free Assembly
Preheat/Soak		
Temperature Min (T_{Smin})	100°C	150°C
Temperature Max (T_{Smax})	150°C	200°C
Time (t_s) from T_{Smin} to T_{Smax}	60–120 sec	60–120 sec
Ramp-up Rate (T_L to T_p)	3°C/sec max	3°C/sec max
Liquidous Temperature (T_L)	183°C	217°C
Time Above Liquidous (t_L)	60–150 sec	60–150 sec
Peak Temperature (T_p)	220°C* 235°C**	250°C* 260°C**
Time within 5°C of Max Peak Temperature (t_p)	20 sec max	30 sec max
Ramp-down Rate (T_p to T_L)	6°C/sec max	6°C/sec max
Time 25°C to Peak Temperature	6 minutes max	8 minutes max

Note: All temperatures refer to the center of the package, measured on the package body surface that is facing up during assembly reflow.

*Case Size D, E, P, Y and X

**Case Size A, B, C, H, I, K, M, R, S, T, U, V, W and Z

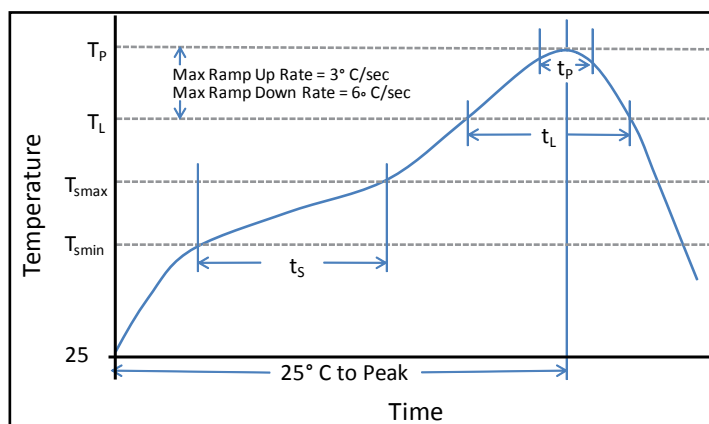

Construction

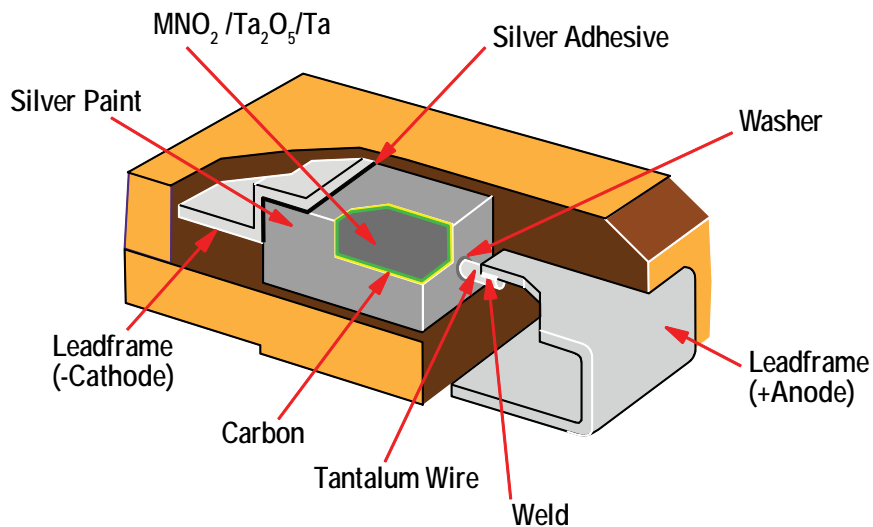

Overview

The KEMET T489 Series provides DC leakage current that is 25% lower than the commercial T491 Series. The T489 series also offers improved reliability, low ESR options and meets or exceeds the requirements of EIA standard 535BAAC. The T489 standard terminations are available in 100% matte tin and provide excellent wetting characteristics and compatibility with today's surface mount solder systems. Tin/lead (Sn/Pb) terminations are available upon request for any part number. Gold-plated terminations are also available for use with conductive epoxy attachment processes. Standard packaging of these devices is tape and reel in accordance with EIA 481-D. This system provides perfect compatibility with all tape-fed placement units.

Benefits

- DC Leakage at 0.0075CV
- Improved reliability: 0.50%/1000hrs, 85°C, Rated Voltage
- Low ESR options available
- Meets or exceeds EIA standard 535BAAC
- Taped and reeled per EIA 481-D
- Symmetrical, compliant terminations
- Laser-marked case
- Halogen-free epoxy
- Capacitance values of 0.1 μ F to 470 μ F
- Tolerances of \pm 10% and \pm 20%
- Voltage rating of 6.3-50 VDC
- RoHS compliance and lead-free terminations
- Operating temperature range of -55°C to +125°C

Applications

Typical applications include decoupling and filtering in industrial and automotive high end applications.



Environmental Compliance

RoHS Compliant (6/6)* according to Directive 2002/95/EC

*When ordered with 100% Sn Solder

SPICE

For a detailed analysis of specific part numbers, please visit kemet.com for a free download of KEMET's SPICE software. The KEMET SPICE program is freeware intended to aid design engineers in analyzing the performance of these capacitors over frequency, temperature, ripple, and DC bias conditions.

Ordering Information – T489 Low DC Leakage MnO₂ Series

T	489	B	156	M	16	A	T	E800
Capacitor Class	Series	Case Size	Capacitance Code (pF)	Capacitance Tolerance	Voltage	Failure Rate/ Design	Lead Material	ESR Code
T = Tantalum	Low DC Leakage Series	A = 3216-18 B = 3528-21 C = 6032-28 D = 7343-31 X = 7343-43	First two digits represent significant figures. Third digit specifies number of zeros.	K = ±10% M = ±20%	006 = 6.3V 010 = 10V 016 = 16V 020 = 20V 025 = 25V 035 = 35V 050 = 50V	A = N/A	T = 100% Matte Tin (Sn) Plated H = Standard Solder Coated (SnPb 5% Pb minimum) G = Gold Plated	E = ESR Last three digits specify ESR in mOhms. (800 = 800mOhms)

Performance Characteristics

Item	Performance Characteristics
Operating Temperature	-55°C to 125°C
Rated Capacitance Range	0.10µF to 470µF @ 120 Hz/25°C
Capacitance Tolerance	K Tolerance (±10%), M Tolerance (±20%)
Rated Voltage Range	6.3V–50V
DF(120Hz)	Refer to Part Number Electrical Specification
ESR (100kHz)	Refer to Part Number Electrical Specification
Leakage Current	≤ 0.0075CV (µA) at rated voltage after 5 minutes
Reliability	0.50% / 1000hrs at 85°C, V _r with 0.1Ω series resistance

Qualification – T489 Low DC Leakage MnO₂ Series

Test	Condition	Characteristics					
Endurance	85°C @ Rated Voltage, 2000 Hours 125°C @ 2/3 Rated Voltage, 2000 Hours	ΔC/C	Within ±10% of initial value				
		DF	Within initial limits				
		DCL	Within 1.25 x initial limit				
		ESR	Within initial limits				
Storage Life	125°C @ 0 Volts, 2000 Hours	ΔC/C	Within ±10% of initial value				
		DF	Within initial limits				
		DCL	Within 1.25 x initial limit				
		ESR	Within initial limits				
Thermal Shock	MIL-STD-202, Method 107, Condition B, mounted, -55°C to 125° C, 1000 cycles	ΔC/C	Within ±5% of initial value				
		DF	Within initial limits				
		DCL	Within 1.25 x initial limit				
		ESR	Within initial limits				
Temperature Stability	Extreme temperature exposure at a succession of continuous steps at +25°C, -55°C, +25°C, +85°C, +125°C, +25°C	+25°C	-55°C	+85°C	+125°C		
		ΔC/C	IL*	±10%	±10%	±20%	
		DF	IL	IL	1.5 x IL	1.5 x IL	
		DCL	IL	n/a	10 x IL	12 x IL	
		Surge Voltage	25°C and 85°C, 1.32 x Rated Voltage 1000 cycles (125°C, 1.2 x Rated Voltage)	ΔC/C	Within ±5% of initial value		
				DF	Within initial limits		
DCL	Within initial limits						
ESR	Within initial limits						
Mechanical Shock/Vibration	MIL-STD-202, Meth. 213, Cond. I, 100G Peak. MIL-STD-202, Meth. 204, Cond. D, 10Hz to 2000Hz, 20G Peak	ΔC/C	Within ±10% of initial value				
		DF	Within initial limits				
		DCL	Within initial limits				

*IL = Initial limit

Certification

KEMET's Internal Qualification Plan for this Tantalum series of capacitors follows AEC-Q200 guidelines. Standard catalog part types ordered without a specific automotive designator, i.e., suffix AUTO or four digit customer specific designator (C SPEC), are not considered KEMET Automotive Grade Tantalum capacitors.

Dimensions – Millimeters (Inches)

Metric will govern

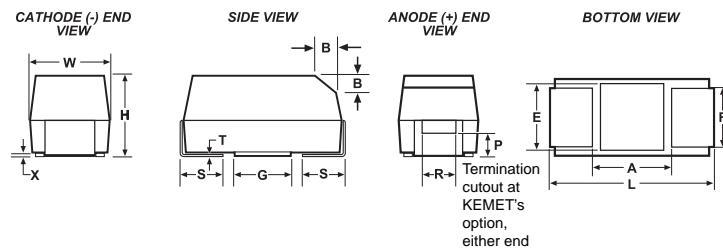

Case Size		Component												
KEMET	EIA	L*	W*	H*	F* ±0.1 ±(.004)	S* ±0.3 ±(.012)	B* ±0.15 (Ref) ±.006	X (Ref)	P (Ref)	R (Ref)	T (Ref)	A (Min)	G (Ref)	E (Ref)
A	3216-18	3.2 ± 0.2 (.126 ± .008)	1.6 ± 0.2 (.063 ± .008)	1.6 ± 0.2 (.063 ± .008)	1.2 (.047)	0.8 (.031)	0.4 (.016)	0.10 ± 0.10 (.004 ± .004)	0.4 (.016)	0.4 (.016)	0.13 (.005)	1.4 (.055)	1.1 (.043)	1.3 (.051)
B	3528-21	3.5 ± 0.2 (.138 ± .008)	2.8 ± 0.2 (.110 ± .008)	1.9 ± 0.2 (.075 ± .008)	2.2 (.087)	0.8 (.031)	0.4 (.016)	0.10 ± 0.10 (.004 ± .004)	0.5 (.020)	1.0 (.039)	0.13 (.005)	2.1 (.083)	1.8 (.071)	2.2 (.087)
C	6032-28	6.0 ± 0.3 (.236 ± .03)	3.2 ± 0.3 (.126 ± .012)	2.5 ± 0.3 (.098 ± .012)	2.2 (.087)	1.3 (.051)	0.5 (.020)	0.10 ± 0.10 (.004 ± .004)	0.9 (.035)	1.0 (.039)	0.13 (.005)	3.1 (.122)	2.8 (.110)	2.4 (.094)
D	7343-31	7.3 ± 0.3 (.287 ± .012)	4.3 ± 0.3 (.169 ± .012)	2.8 ± 0.3 (.110 ± .012)	2.4 (.094)	1.3 (.051)	0.5 (.020)	0.10 ± 0.10 (.004 ± .004)	0.9 (.035)	1.0 (.039)	0.13 (.005)	3.8 (.150)	3.5 (.138)	3.5 (.138)
X	7343-43	7.3 ± 0.3 (.287 ± .012)	4.3 ± 0.3 (.169 ± .012)	4.0 ± 0.3 (.157 ± .012)	2.4 (.094)	1.3 (.051)	0.5 (.020)	0.10 ± 0.10 (.004 ± .004)	1.7 (.067)	1.0 (.039)	0.13 (.005)	3.8 (.150)	3.5 (.138)	3.5 (.138)

* MIL-C-55365/8 specified dimensions

Table 1 – T489 Low DC Leakage MnO₂ Series Ratings & Part Number Reference

Rated Voltage	Rated Cap	Case Code/ Case Size	KEMET Part Number	DC Leakage	DF	Std ESR		Low ESR	
						+25°C 100kHz	Espec Code	+25°C 100kHz	Espec Code
VDC	120Hz µF	KEMET/EIA	(See below for part options)	µAmps +25°C max/5min	+25°C 120Hz % Max	+25°C 100kHz mOhms		+25°C 100kHz mOhms	
6.3	10	B/3528-21	T489B106(1)006A(2)	0.5	6.0	3000	E3K0		
6.3	15	A/3216-18	T489A156(1)006A(2)	0.7	6.0	2030	E2K0	1500	E1K5
6.3	22	C/6032-28	T489C226(1)006A(2)	1.0	6.0	2000	E2K0		
6.3	47	B/3528-21	T489B476(1)006A(2)	2.1	6.0	1620	E1K6	500	E500
6.3	150	B/3528-21	T489B157(1)006A(2)	7.1	15.0	3000	E3K0		
6.3	100	C/6032-28	T489C107(1)006A(2)	4.5	6.0	440	E440		
6.3	150	C/6032-28	T489C157(1)006A(2)	6.8	8.0	500	E500	300	E300
6.3	100	D/7343-31	T489D107(1)006A(2)	4.7	8.0	800	E800		
6.3	150	D/7343-31	T489D157(1)006A(2)	6.8	6.0	400	E400	150	E150
6.3	220	D/7343-31	T489D227(1)006A(2)	9.9	8.0	360	E360	150	E150
6.3	470	X/7343-43	T489X477(1)006A(2)	21.0	8.0	250	E250	200	E200
10	2.2	A/3216-18	T489A225(1)010A(2)	0.3	6.0	7000	E7K0		
10	4.7	A/3216-18	T489A475(1)010A(2)	0.4	6.0	2900	E2K9		
10	6.8	A/3216-18	T489A685(1)010A(2)	0.5	6.0	2650	E2K6		
10	6.8	B/3528-21	T489B685(1)010A(2)	0.5	6.0	3000	E3K0		
10	10	A/3216-18	T489A106(1)010A(2)	0.8	6.0	2200	E2K2	1800	E1K8
10	15	B/3528-21	T489B156(1)010A(2)	1.1	6.0	2030	E2K0		
10	15	C/6032-28	T489C156(1)010A(2)	1.1	6.0	2000	E2K0		
10	22	B/3528-21	T489B226(1)010A(2)	1.7	6.0	1880	E1K8	700	E700
10	33	B/3528-21	T489B336(1)010A(2)	2.5	6.0	1000	E1K0	650	E650
10	33	C/6032-28	T489C336(1)010A(2)	2.5	6.0	590	E590		
10	33	D/7343-31	T489D336(1)010A(2)	2.5	6.0	1100	E1K1		
10	47	C/6032-28	T489C476(1)010A(2)	3.5	6.0	540	E540		
10	47	D/7343-31	T489D476(1)010A(2)	3.5	6.0	400	E400		
10	68	C/6032-28	T489C686(1)010A(2)	5.1	6.0	490	E490		
10	100	C/6032-28	T489C107(1)010A(2)	7.5	8.0	500	E500		
10	100	D/7343-31	T489D107(1)010A(2)	7.5	6.0	440	E440	150	E150
10	150	D/7343-31	T489D157(1)010A(2)	11.0	8.0	400	E400	150	E150
10	220	D/7343-31	T489D227(1)010A(2)	16.5	8.0	500	E500		
10	330	X/7343-43	T489X337(1)010A(2)	25.0	8.0	300	E300	100	E100
16	1	A/3216-18	T489A105(1)016A(2)	0.3	6.0	10000	E10K		
16	2.2	A/3216-18	T489A225(1)016A(2)	0.3	6.0	4550	E4K5	3500	E3K5
16	3.3	B/3528-21	T489B335(1)016A(2)	0.4	6.0	4500	E4K5		
16	4.7	B/3528-21	T489B475(1)016A(2)	0.6	6.0	3160	E3K1		
16	6.8	B/3528-21	T489B685(1)016A(2)	0.8	6.0	2650	E2K6		
16	6.8	C/6032-28	T489C685(1)016A(2)	0.8	6.0	2500	E2K5		
16	10	B/3528-21	T489B106(1)016A(2)	1.2	6.0	2200	E2K2		
16	10	C/6032-28	T489C106(1)016A(2)	1.2	6.0	2000	E2K0		
16	15	B/3528-21	T489B156(1)016A(2)	1.8	6.0	2030	E2K0	800	E800
16	22	B/3528-21	T489B226(1)016A(2)	2.6	6.0	1100	E1K1	600	E600
16	22	C/6032-28	T489C226(1)016A(2)	2.6	6.0	700	E700	350	E350
16	22	D/7343-31	T489D226(1)016A(2)	2.6	6.0	1100	E1K1		
16	33	C/6032-28	T489C336(1)016A(2)	4.0	6.0	590	E590		
16	47	C/6032-28	T489C476(1)016A(2)	5.6	6.0	540	E540	350	E350
16	47	D/7343-31	T489D476(1)016A(2)	5.6	6.0	540	E540	200	E200
16	68	D/7343-31	T489D686(1)016A(2)	8.2	6.0	490	E490	150	E150
16	100	D/7343-31	T489D107(1)016A(2)	12.0	6.0	440	E440	150	E150
16	150	D/7343-31	T489D157(1)016A(2)	18.0	12.0	700	E700		
20	1	A/3216-18	T489A105(1)020A(2)	0.3	4.0	6630	E6K6		
VDC	µF	KEMET/EIA	(See below for part options)	max/5min	% Max	mOhms	Espec Code	mOhms	Espec Code
Rated Voltage	Rated Cap	Case Code/ Case Size	KEMET Part Number	DC Leakage	DF	Std ESR		Low ESR	

(1) To complete KEMET part number, insert M for ± 20% or K for ± 10%. Designates Capacitance tolerance.

(2) To complete KEMET part number, insert T = 100% Matte Tin (Sn) Plated, G = Gold Plated, H = Standard Solder coated (SnPb 5% Pb minimum). Designates Termination Finish.

Refer to Ordering Information for additional detail.

Higher voltage ratings and tighter tolerance product including ESR may be substituted within the same size at KEMET's option. Voltage substitution will be marked with the higher voltage rating. Substitutions can include better than series.

Table 1 – T489 Low DC Leakage MnO₂ Series Ratings & Part Number Reference con't

Rated Voltage	Rated Cap	Case Code/ Case Size	KEMET Part Number	DC Leakage	DF	Std ESR		Low ESR	
						+25°C 100kHz	Espec Code	+25°C 100kHz	Espec Code
VDC	120Hz µF	KEMET/EIA	(See below for part options)	µAmps +25°C max/5min	+25°C 120Hz % Max	+25°C 100kHz mOhms	Espec Code	+25°C 100kHz mOhms	Espec Code
20	1.5	A/3216-18	T489A155(1)020A(2)	0.3	6.0	5460	E5K4		
20	2.2	A/3216-18	T489A225(1)020A(2)	0.3	6.0	4550	E4K5		
20	3.3	A/3216-18	T489A335(1)020A(2)	0.5	6.0	3740	E3K7	3500	E3K5
20	3.3	B/3528-21	T489B335(1)020A(2)	0.5	6.0	3740	E3K7		
20	4.7	B/3528-21	T489B475(1)020A(2)	0.7	6.0	3160	E3K1		
20	6.8	B/3528-21	T489B685(1)020A(2)	1.0	6.0	2650	E2K6		
20	6.8	C/6032-28	T489C685(1)020A(2)	1.0	6.0	2000	E2K0		
20	10	B/3528-21	T489B106(1)020A(2)	1.5	6.0	2200	E2K2	1000	E1K0
20	10	C/6032-28	T489C106(1)020A(2)	1.5	6.0	800	E800	500	E500
20	15	C/6032-28	T489C156(1)020A(2)	2.3	6.0	720	E720	400	E400
20	15	D/7343-31	T489D156(1)020A(2)	2.3	6.0	1100	E1K1		
20	22	D/7343-31	T489D226(1)020A(2)	3.3	6.0	650	E650	300	E300
20	33	C/6032-28	T489C336(1)020A(2)	5.0	6.0	590	E590	300	E300
20	33	D/7343-31	T489D336(1)020A(2)	5.0	6.0	590	E590	250	E250
20	47	D/7343-31	T489D476(1)020A(2)	7.1	6.0	540	E540	200	E200
20	68	D/7343-31	T489D686(1)020A(2)	10.0	6.0	490	E490	200	E200
20	100	X/7343-43	T489X107(1)020A(2)	15.0	6.0	300	E300	150	E150
25	0.47	A/3216-18	T489A474(1)025A(2)	0.3	4.0	9530	E9K5	7000	E7K0
25	0.68	A/3216-18	T489A684(1)025A(2)	0.3	4.0	7980	E7K9		
25	1	A/3216-18	T489A105(1)025A(2)	0.3	4.0	6630	E6K6		
25	2.2	B/3528-21	T489B225(1)025A(2)	0.4	6.0	4550	E4K5		
25	3.3	B/3528-21	T489B335(1)025A(2)	0.6	6.0	3740	E3K7	2000	E2K0
25	4.7	B/3528-21	T489B475(1)025A(2)	0.9	6.0	3160	E3K1	1000	E1K0
25	6.8	B/3528-21	T489B685(1)025A(2)	1.3	6.0	1500	E1K5	1000	E1K0
25	6.8	C/6032-28	T489C685(1)025A(2)	1.3	6.0	1070	E1K0	600	E600
25	10	C/6032-28	T489C106(1)025A(2)	1.9	6.0	800	E800	600	E600
25	10	D/7343-31	T489D106(1)025A(2)	1.9	6.0	1200	E1K2		
25	15	C/6032-28	T489C156(1)025A(2)	2.8	6.0	720	E720		
25	15	D/7343-31	T489D156(1)025A(2)	2.8	6.0	720	E720	300	E300
25	22	D/7343-31	T489D226(1)025A(2)	4.1	6.0	650	E650	300	E300
25	33	D/7343-31	T489D336(1)025A(2)	6.2	6.0	590	E590	400	E400
25	47	D/7343-31	T489D476(1)025A(2)	8.8	6.0	540	E540	250	E250
35	0.1	A/3216-18	T489A104(1)035A(2)	0.3	4.0	20000	E20K		
35	0.22	A/3216-18	T489A224(1)035A(2)	0.3	4.0	13710	E13K		
35	0.33	A/3216-18	T489A334(1)035A(2)	0.3	4.0	11280	E11K		
35	1	A/3216-18	T489A105(1)035A(2)	0.3	4.0	6630	E6K6	3000	E3K0
35	1	B/3528-21	T489B105(1)035A(2)	0.3	4.0	3400	E3K4	2000	E2K0
35	1.5	B/3528-21	T489B155(1)035A(2)	0.4	6.0	5460	E5K4	2500	E2K5
35	2.2	B/3528-21	T489B225(1)035A(2)	0.6	6.0	4550	E4K5	2000	E2K0
35	3.3	B/3528-21	T489B335(1)035A(2)	0.9	6.0	3740	E3K7		
35	3.3	C/6032-28	T489C335(1)035A(2)	0.9	6.0	1840	E1K8	800	E800
35	4.7	C/6032-28	T489C475(1)035A(2)	1.2	6.0	1410	E1K4	600	E600
35	4.7	D/7343-31	T489D475(1)035A(2)	1.2	6.0	1500	E1K5		
35	6.8	C/6032-28	T489C685(1)035A(2)	1.8	6.0	1070	E1K0	600	E600
35	6.8	D/7343-31	T489D685(1)035A(2)	1.8	6.0	1300	E1K3		
35	10	C/6032-28	T489C106(1)035A(2)	2.6	6.0	800	E800	600	E600
35	10	D/7343-31	T489D106(1)035A(2)	2.6	6.0	800	E800	400	E400
35	15	D/7343-31	T489D156(1)035A(2)	3.9	6.0	720	E720	350	E350
35	22	D/7343-31	T489D226(1)035A(2)	5.8	6.0	650	E650	300	E300
VDC	µF 120Hz	KEMET/EIA	(See below for part options)	max/5min µAmps +25°C	% Max +25°C 120Hz	mOhms +25°C 100kHz	Espec Code	mOhms +25°C 100kHz	Espec Code
Rated Voltage	Rated Cap	Case Code/ Case Size	KEMET Part Number	DC Leakage	DF	Std ESR	Low ESR		

(1) To complete KEMET part number, insert M for ± 20% or K for ± 10%. Designates Capacitance tolerance.

(2) To complete KEMET part number, insert T = 100% Matte Tin (Sn) Plated, G = Gold Plated, H = Standard Solder coated (SnPb 5% Pb minimum). Designates Termination Finish.

Refer to Ordering Information for additional detail.

Higher voltage ratings and tighter tolerance product including ESR may be substituted within the same size at KEMET's option. Voltage substitution will be marked with the higher voltage rating. Substitutions can include better than series.

Table 1 – T489 Low DC Leakage MnO₂ Series Ratings & Part Number Reference con't

Rated Voltage	Rated Cap	Case Code/ Case Size	KEMET Part Number	DC Leakage	DF	Std ESR		Low ESR	
						+25°C 100kHz	Espec	+25°C 100kHz	Espec
VDC	120Hz µF	KEMET/EIA	(See below for part options)	µAmps +25°C max/5min	+25°C 120Hz % Max	+25°C 100kHz mOhms	Espec Code	+25°C 100kHz mOhms	Espec Code
50	0.22	A/3216-18	T489A224(1)050A(2)	0.3	4.0	7500	E7K5	7000	E7K0
50	0.33	A/3216-18	T489A334(1)050A(2)	0.3	4.0	7000	E7K0		
50	0.68	B/3528-21	T489B684(1)050A(2)	0.3	4.0	4000	E4K0	2000	E2K0
50	1	C/6032-28	T489C105(1)050A(2)	0.4	4.0	3000	E3K0		
50	1.5	C/6032-28	T489C155(1)050A(2)	0.6	6.0	2500	E2K5	1500	E1K5
50	2.2	C/6032-28	T489C225(1)050A(2)	0.8	6.0	1700	E1K7	1000	E1K0
50	2.2	D/7343-31	T489D225(1)050A(2)	0.8	4.5	2000	E2K0	1200	E1K2
50	3.3	D/7343-31	T489D335(1)050A(2)	1.2	4.5	1100	E1K1	800	E800
50	4.7	D/7343-31	T489D475(1)050A(2)	1.8	4.5	900	E900	600	E600
50	6.8	D/7343-31	T489D685(1)050A(2)	2.6	4.5	700	E700		
VDC	µF 120Hz	KEMET/EIA	(See below for part options)	max/5min µAmps +25°C	% Max +25°C 120Hz	mOhms +25°C 100kHz	Espec Code	mOhms +25°C 100kHz	Espec Code
Rated Voltage	Rated Cap	Case Code/ Case Size	KEMET Part Number	DC Leakage	DF	Std ESR		Low ESR	

(1) To complete KEMET part number, insert M for $\pm 20\%$ or K for $\pm 10\%$. Designates Capacitance tolerance.

(2) To complete KEMET part number, insert T = 100% Matte Tin (Sn) Plated, G = Gold Plated, H = Standard Solder coated (SnPb 5% Pb minimum). Designates Termination Finish.

Refer to Ordering Information for additional detail.

Higher voltage ratings and tighter tolerance product including ESR may be substituted within the same size at KEMET's option. Voltage substitution will be marked with the higher voltage rating. Substitutions can include better than series.

Recommended Voltage Derating Guidelines

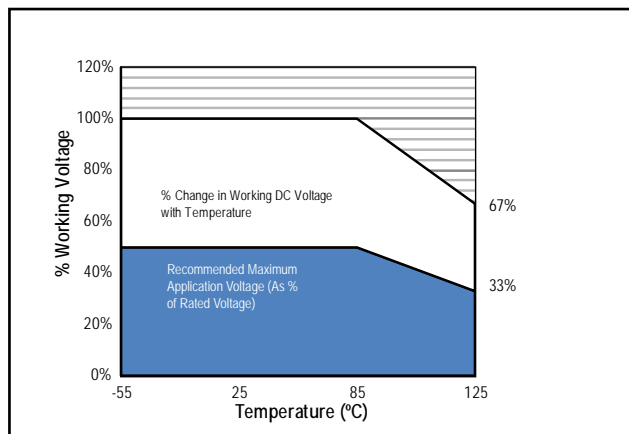

Ripple Current/Ripple Voltage

Case Code		Maximum Power Dissipation (Pmax) mWatts @ 25°C w/+20°C Rise
KEMET	EIA	
A	3216-18	75
B	3528-21	85
C	6032-28	110
D	7343-31	150
X	7343-43	165
E	7260-38	200
R	2012-12	25
S	3216-12	60
T	3528-12	70
U	6032-15	90
V	7343-20	125
T510X	7343-43	270
T510E	7260-38	285

Temperature Compensation Multipliers for Maximum Power Dissipation		
≤25°C	85°C	125°C
1.00	0.90	0.40

T = Environmental Temperature

Using the P max of the device, the maximum allowable rms ripple current or voltage may be determined.

$$I(max) = \sqrt{P_{max}/R}$$

$$E(max) = \sqrt{P_{max} \cdot R}$$

I = rms ripple current (amperes)

E = rms ripple voltage (volts)

*P*_{max} = maximum power dissipation (watts)

R = ESR at specified frequency (ohms)

Reverse Voltage

Solid tantalum capacitors are polar devices and may be permanently damaged or destroyed if connected with the wrong polarity. The positive terminal is identified on the capacitor body by a stripe plus in some cases a beveled edge. A small degree of transient reverse voltage is permissible for short periods per the table. The capacitors should not be operated continuously in reverse mode, even within these limits.

Temperature	Permissible Transient Reverse Voltage
25°C	15% of Rated Voltage
85°C	5% of Rated Voltage
125°C	1% of Rated Voltage

Table 2 – Land Dimensions/Courtyard

KEMET	Metric Size Code	Density Level A: Maximum (Most) Land Protrusion (mm)					Density Level B: Median (Nominal) Land Protrusion (mm)					Density Level C: Minimum (Least) Land Protrusion (mm)				
		X	Y	C	V1	V2	X	Y	C	V1	V2	X	Y	C	V1	V2
Case	EIA	X	Y	C	V1	V2	X	Y	C	V1	V2	X	Y	C	V1	V2
A	3216-18	1.35	2.15	1.45	6.10	2.80	1.25	1.75	1.35	5.00	2.30	1.15	1.35	1.25	4.10	2.00
B	3528-21	2.35	2.15	1.45	6.10	4.00	2.25	1.75	1.35	5.00	3.50	2.15	1.35	1.25	4.10	3.20
C	6032-28	2.35	2.65	2.60	8.90	4.40	2.25	2.25	2.50	7.80	3.90	2.15	1.85	2.40	6.90	3.60
D	7343-31	2.55	3.75	2.70	10.20	5.50	2.45	3.35	2.60	9.10	5.00	2.35	2.95	2.50	8.20	4.70
E ¹	7260-38	4.25	2.65	3.20	10.10	7.20	4.15	2.25	3.30	9.40	6.70	4.05	1.85	3.00	8.10	6.40
R	2012-12	1.05	1.80	1.00	4.80	2.40	0.95	1.45	0.90	3.80	1.90	0.85	1.05	0.80	2.90	1.60
S ²	3216-12	1.35	2.15	1.45	6.10	2.80	1.25	1.75	1.35	5.00	2.30	1.15	1.35	1.25	4.10	2.00
T	3528-12	2.35	2.15	1.45	6.10	4.00	2.25	1.75	1.35	5.00	3.50	2.15	1.35	1.25	4.10	3.20
U	6032-15	2.55	3.75	2.70	10.20	5.50	2.45	3.35	2.60	9.10	5.00	2.35	2.95	2.50	8.20	4.70
V	7343-20	2.55	3.75	2.70	10.20	5.50	2.45	3.35	2.60	9.10	5.00	2.35	2.95	2.50	8.20	4.70
X ¹	7343-43	2.55	3.75	2.70	10.20	5.50	2.45	3.35	2.60	9.10	5.00	2.35	2.95	2.50	8.20	4.70

Density Level A: For low-density product applications. Recommended for wave solder applications and provides a wider process window for reflow solder processes.

Density Level B: For products with a moderate level of component density. Provides a robust solder attachment condition for reflow solder processes.

Density Level C: For high component density product applications. Before adapting the minimum land pattern variations the user should perform qualification testing based on the conditions outlined in IPC standard 7351 (IPC-7351).

¹ Height of these chips may create problems in wave soldering.

² Land pattern geometry is too small for silkscreen outline.

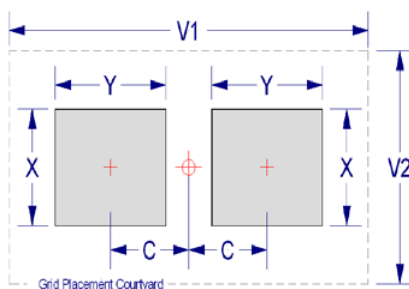

Soldering Process

KEMET's families of surface mount capacitors are compatible with wave (single or dual), convection, IR or vapor phase reflow techniques. Preheating of these components is recommended to avoid extreme thermal stress. KEMET's recommended profile conditions for convection and IR reflow reflect the profile conditions of the IPC/J-STD-020D standard for moisture sensitivity testing. The devices can safely withstand a maximum of three reflow passes at these conditions.

Note that although the X/7343-43 case size can withstand wave soldering, the tall profile (4.3 mm maximum) dictates care in wave process development.

Hand soldering should be performed with care due to the difficulty in process control. If performed, care should be taken to avoid contact of the soldering iron to the molded case. The iron should be used to heat the solder pad, applying solder between the pad and the termination, until reflow occurs. Once reflow occurs, the iron should be removed immediately. "Wiping" the edges of a chip and heating the top surface is not recommended.

During typical reflow operations, a slight darkening of the gold-colored epoxy may be observed. This slight darkening is normal and is not harmful to the product. Marking permanency is not affected by this change.

Profile Feature	SnPb Assembly	Pb-Free Assembly
Preheat/Soak		
Temperature Min (T_{Smin})	100°C	150°C
Temperature Max (T_{Smax})	150°C	200°C
Time (t_s) from T_{Smin} to T_{Smax}	60–120 sec	60–120 sec
Ramp-up Rate (T_L to T_p)	3°C/sec max	3°C/sec max
Liquidous Temperature (T_L)	183°C	217°C
Time Above Liquidous (t_L)	60–150 sec	60–150 sec
Peak Temperature (T_p)	220°C* 235°C**	250°C* 260°C**
Time within 5°C of Max Peak Temperature (t_p)	20 sec max	30 sec max
Ramp-down Rate (T_p to T_L)	6°C/sec max	6°C/sec max
Time 25°C to Peak Temperature	6 minutes max	8 minutes max

Note: All temperatures refer to the center of the package, measured on the package body surface that is facing up during assembly reflow.

*Case Size D, E, P, Y and X

**Case Size A, B, C, H, I, K, M, R, S, T, U, V, W and Z

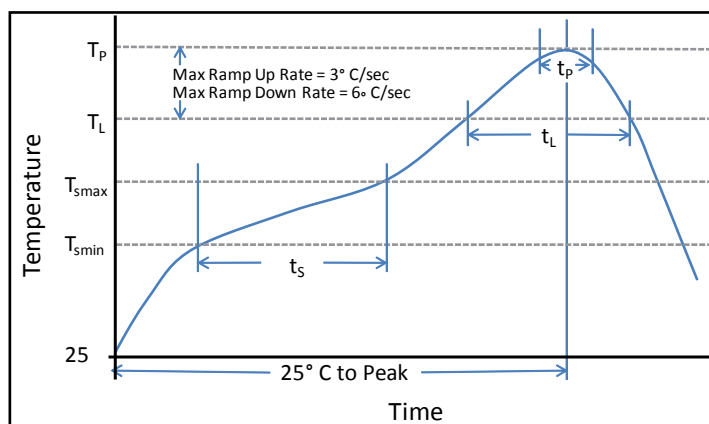

Construction

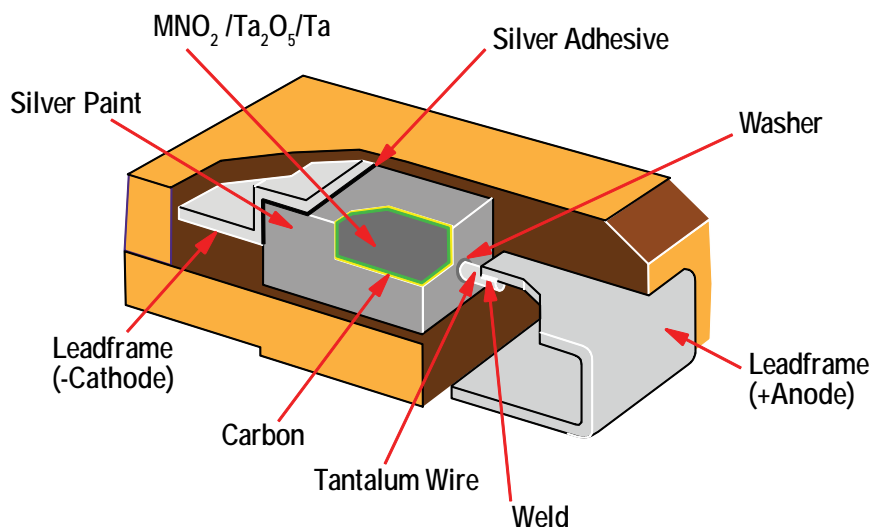

Capacitor Marking

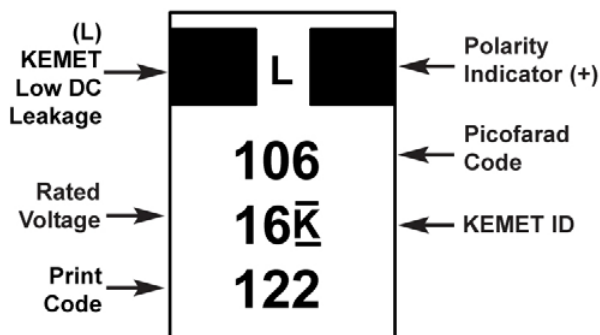

Storage

Tantalum chip capacitors should be stored in normal working environments. While the chips themselves are quite robust in other environments, solderability will be degraded by exposure to high temperatures, high humidity, corrosive atmospheres, and long term storage. In addition, packaging materials will be degraded by high temperature - reels may soften or warp, and tape peel force may increase. KEMET recommends that maximum storage temperature not exceed 40°C, and maximum storage humidity not exceed 60% relative humidity. In addition, temperature fluctuations should be minimized to avoid condensation on the parts, and atmospheres should be free of chlorine and sulphur bearing compounds. For optimized solderability, chip stock should be used promptly, preferably within three years of receipt.

Tape & Reel Packaging Information

KEMET's Molded Tantalum and Aluminum Chip Capacitor families are packaged in 8 mm and 12 mm plastic tape on 7" and 13" reels, in accordance with EIA Standard 481-D: Taping of Surface Mount Components for Automatic Handling. This packaging system is compatible with all tape fed automatic pick and place systems.

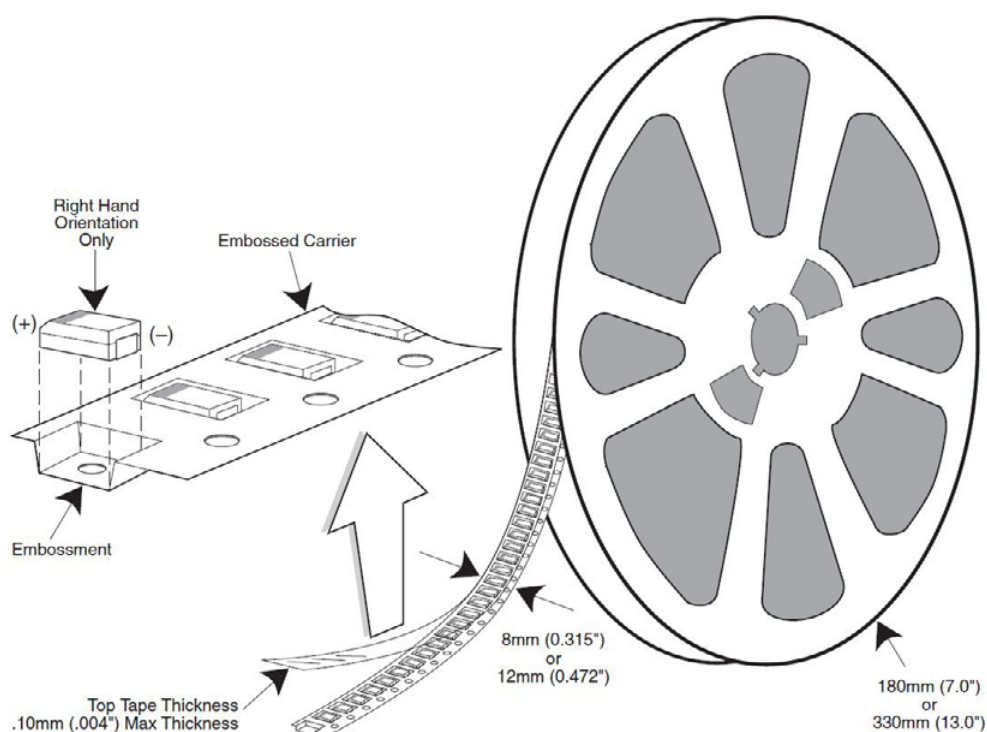

Table 3 – Packaging Quantity

Case Code		Tape Width-mm	7" Reel*	13" Reel*
KEMET	EIA			
R	2012-12	8	2,500	10,000
I	3216-10	8	3,000	12,000
S	3216-12	8	2,500	10,000
T	3528-12	8	2,500	10,000
M	3528-15	8	2,000	8,000
U	6032-15	12	1,000	5,000
L	6032-19	12	1,000	5,000
W	7343-15	12	1,000	3,000
Z	7343-17	12	1,000	3,000
V	7343-20	12	1,000	3,000
A	3216-18	8	2,000	9,000
B	3528-21	8	2,000	8,000
C	6032-28	12	500	3,000
D	7343-31	12	500	2,500
Y	7343-40	12	500	2,000
X	7343-43	12	500	2,000
E	7260-38	12	500	2,000

* No c-spec required for 7" reel packaging. C-7280 required for 13" reel packaging.

Figure 1 – Embossed (Plastic) Carrier Tape Dimensions

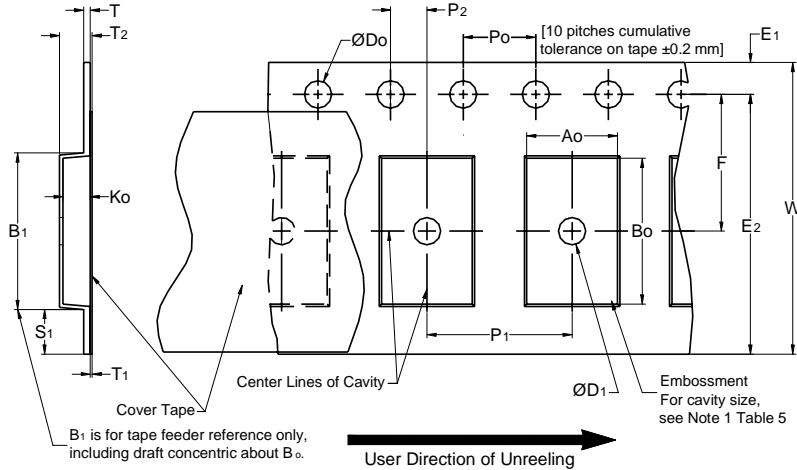

Table 4 – Embossed (Plastic) Carrier Tape Dimensions

Metric will govern

Constant Dimensions — Millimeters (Inches)									
Tape Size	D_0	D_1 Min. Note 1	E_1	P_0	P_2	R Ref. Note 2	S_1 Min. Note 3	T Max.	T_1 Max.
8mm	$1.5 +0.10/-0.0$ (0.059 +0.004/-0.0)	1.0 (0.039)	1.75 ± 0.10 (0.069 ± 0.004)	4.0 ± 0.10 (0.157 ± 0.004)	2.0 ± 0.05 (0.079 ± 0.002)	25.0 (0.984)	0.600 (0.024)	0.600 (0.024)	0.100 (0.004)
12mm		1.5 (0.059)				30 (1.181)			
16mm									
Variable Dimensions — Millimeters (Inches)									
Tape Size	Pitch	B_1 Max. Note 4	E_2 Min.	F	P_1	T_2 Max	W Max	A_0, B_0 & K_0	
8mm	Single (4mm)	4.35 (0.171)	6.25 (0.246)	3.5 ± 0.05 (0.138 ± 0.002)	4.0 ± 0.10 (0.157 ± 0.004)	2.5 (0.098)	8.3 (0.327)	Note 5	
12mm	Single (4mm) & Double (8mm)	8.2 (0.323)	10.25 (0.404)	5.5 ± 0.05 (0.217 ± 0.002)	8.0 ± 0.10 (0.315 ± 0.004)	4.6 (0.181)	12.3 (0.484)		
16mm	Triple (12mm)	12.1 (0.476)	14.25 (0.561)	5.5 ± 0.05 (0.217 ± 0.002)	8.0 ± 0.10 (0.315 ± 0.004)	4.6 (0.181)	16.3 (0.642)		

1. The embossment hole location shall be measured from the sprocket hole controlling the location of the embossment. Dimensions of embossment location and hole location shall be applied independent of each other.
2. The tape with or without components shall pass around R without damage (see Figure 5).
3. If $S_1 < 1.0$ mm, there may not be enough area for cover tape to be properly applied (see EIA Document 481 paragraph 4.3 (b)).
4. B_1 dimension is a reference dimension for tape feeder clearance only.
5. The cavity defined by A_0 , B_0 and K_0 shall surround the component with sufficient clearance that:
 - (a) the component does not protrude above the top surface of the carrier tape.
 - (b) the component can be removed from the cavity in a vertical direction without mechanical restriction, after the top cover tape has been removed.
 - (c) rotation of the component is limited to 20° maximum for 8 and 12mm tapes and 10° maximum for 16mm tapes (see Figure 3).
 - (d) lateral movement of the component is restricted to 0.5 mm maximum for 8mm and 12mm wide tape and to 1.0mm maximum for 16mm tape (see Figure 4).
 - (e) see Addendum in EIA Document 481 for standards relating to more precise taping requirements.

Packaging Information Performance Notes

1. Cover Tape Break Force: 1.0 Kg minimum.
2. Cover Tape Peel Strength: The total peel strength of the cover tape from the carrier tape shall be:

Tape Width	Peel Strength
8mm	0.1 Newton to 1.0 Newton (10gf to 100gf)
12mm & 16mm	0.1 Newton to 1.3 Newton (10gf to 130gf)

The direction of the pull shall be opposite the direction of the carrier tape travel. The pull angle of the carrier tape shall be 165° to 180° from the plane of the carrier tape. During peeling, the carrier and/or cover tape shall be pulled at a velocity of 300±10 mm/minute.

3. Labeling: Bar code labeling (standard or custom) shall be on the side of the reel opposite the sprocket holes. Refer to EIA-556 and EIA-624.

Figure 2 – Maximum Component Rotation

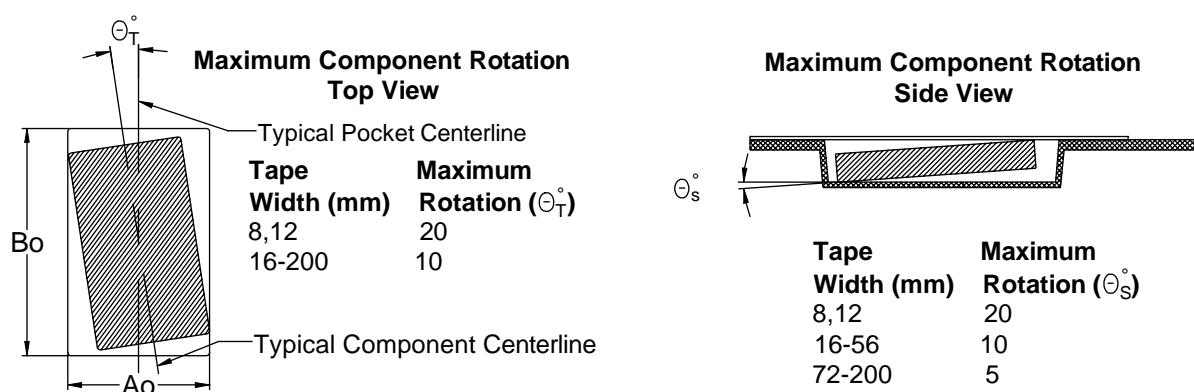

Figure 3 – Maximum Lateral Movement

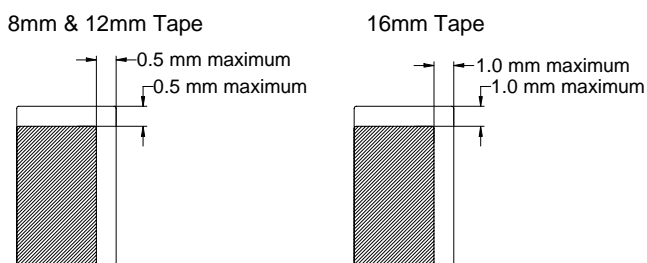

Figure 4 – Bending Radius

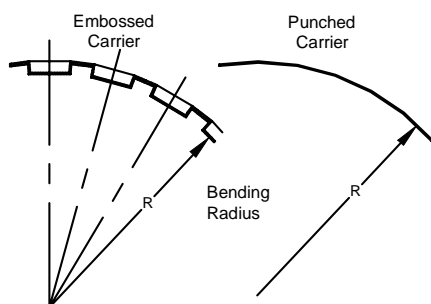
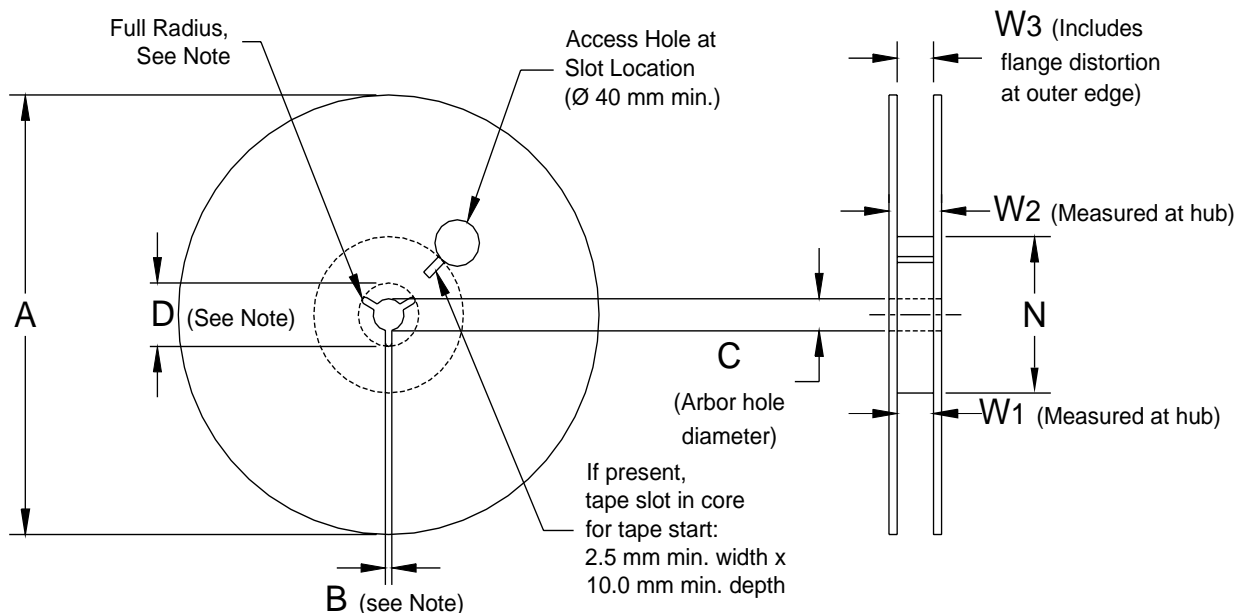

Figure 5 – Reel Dimensions



Note: Drive spokes optional; if used, dimensions B and D shall apply.

Table 5 – Reel Dimensions

Metric will govern

Constant Dimensions – Millimeters (Inches)				
Tape Size	A	B Min	C	D Min
8mm	178 ± 0.20 (7.008 ± 0.008)	1.5 (0.059)	$13.0 +0.5/-0.2$ ($0.521 +0.02/-0.008$)	20.2 (0.795)
12mm	or			
16mm	330 ± 0.20 (13.000 ± 0.008)			
Variable Dimensions – Millimeters (Inches)				
Tape Size	N Min	W_1	W_2 Max	W_3
8mm	50 (1.969)	$8.4 +1.5/-0.0$ ($0.331 +0.059/-0.0$)	14.4 (0.567)	Shall accommodate tape width without interference
12mm		$12.4 +2.0/-0.0$ ($0.488 +0.078/-0.0$)	18.4 (0.724)	
16mm		$16.4 +2.0/-0.0$ ($0.646 +0.078/-0.0$)	22.4 (0.882)	

Figure 6 – Tape Leader & Trailer Dimensions

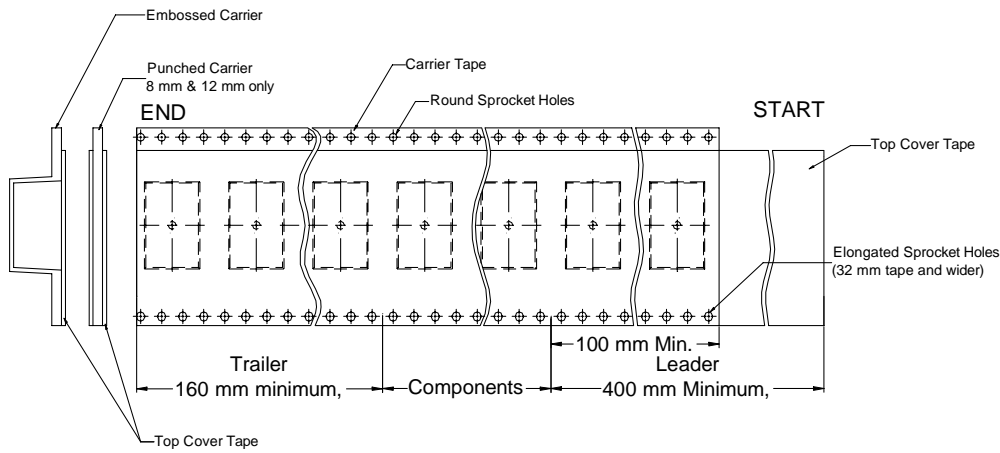
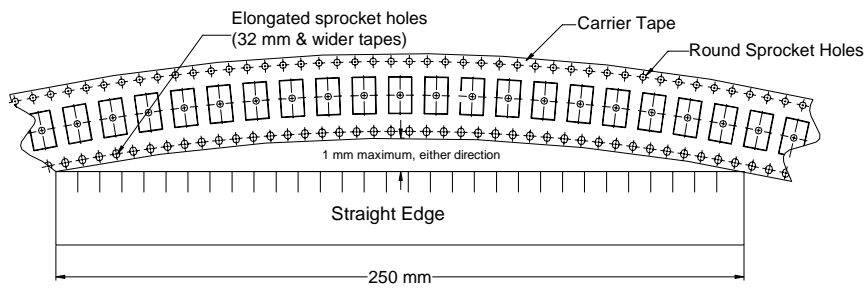

Figure 7 – Maximum Camber



KEMET Corporation World Headquarters

2835 KEMET Way
Simpsonville, SC 29681

Mailing Address:
P.O. Box 5928
Greenville, SC 29606

www.kemet.com
Tel: 864-963-6300
Fax: 864-963-6521

Corporate Offices

Fort Lauderdale, FL
Tel: 954-766-2800

North America

Southeast

Lake Mary, FL
Tel: 407-855-8886

Northeast

Wilmington, MA
Tel: 978-658-1663

West Chester, PA
Tel: 610-692-4642

Central

Schaumburg, IL
Tel: 847-882-3590

Carmel, IN
Tel: 317-706-6742

West

Milpitas, CA
Tel: 408-433-9950

Mexico

Zapopan, Jalisco
Tel: 52-33-3123-2141

Europe

Southern Europe

Geneva, Switzerland
Tel: 41-22-715-0100

Paris, France
Tel: 33-1-4646-1009

Sasso Marconi, Italy
Tel: 39-051-939111

Milan, Italy
Tel: 39-02-57518176

Rome, Italy
Tel: 39-06-23231718

Madrid, Spain
Tel: 34-91-804-4303

Central Europe

Landsberg, Germany
Tel: 49-8191-3350800

Dortmund, Germany
Tel: 49-2307-3619672

Kwidzyn, Poland
Tel: 48-55-279-7025

Northern Europe

Bishop's Stortford, United Kingdom
Tel: 44-1279-757201

Weymouth, United Kingdom
Tel: 44-1305-830747

Coatbridge, Scotland
Tel: 44-1236-434455

Färjestaden, Sweden
Tel: 46-485-563934

Espoo, Finland
Tel: 358-9-5406-5000

Asia

Northeast Asia

Hong Kong
Tel: 852-2305-1168

Shenzhen, China
Tel: 86-755-2518-1306

Beijing, China
Tel: 86-10-5829-1711

Shanghai, China
Tel: 86-21-6447-0707

Taipei, Taiwan
Tel: 886-2-27528585

Southeast Asia

Singapore
Tel: 65-6586-1900

Penang, Malaysia
Tel: 60-4-6430200

Bangalore, India
Tel: 91-806-53-76817

Note: KEMET reserves the right to modify minor details of internal and external construction at any time in the interest of product improvement. KEMET does not assume any responsibility for infringement that might result from the use of KEMET Capacitors in potential circuit designs. KEMET is a registered trademark of KEMET Electronics Corporation.

Other KEMET Resources

Tools	
Resource	Location
Configure A Part: CapEdge	http://capacitoredge.kemet.com
SPICE & FIT Software	http://www.kemet.com/spice
Search Our FAQs: KnowledgeEdge	http://www.kemet.com/keask

Product Information	
Resource	Location
Products	http://www.kemet.com/products
Technical Resources (Including Soldering Techniques)	http://www.kemet.com/technicalpapers
RoHS Statement	http://www.kemet.com/rohs
Quality Documents	http://www.kemet.com/qualitydocuments

Product Request	
Resource	Location
Sample Request	http://www.kemet.com/sample
Engineering Kit Request	http://www.kemet.com/kits

Contact	
Resource	Location
Website	www.kemet.com
Contact Us	http://www.kemet.com/contact
Investor Relations	http://www.kemet.com/ir
Call Us	1-877-MyKEMET
Twitter	http://twitter.com/kemetcapacitors

Disclaimer

All product specifications, statements, information and data (collectively, the "Information") are subject to change without notice.

All Information given herein is believed to be accurate and reliable, but is presented without guarantee, warranty, or responsibility of any kind, expressed or implied.

Statements of suitability for certain applications are based on our knowledge of typical operating conditions for such applications, but are not intended to constitute – and we specifically disclaim – any warranty concerning suitability for a specific customer application or use. This Information is intended for use only by customers who have the requisite experience and capability to determine the correct products for their application. Any technical advice inferred from this Information or otherwise provided by us with reference to the use of our products is given gratis, and we assume no obligation or liability for the advice given or results obtained.

Although we design and manufacture our products to the most stringent quality and safety standards, given the current state of the art, isolated component failures may still occur. Accordingly, customer applications which require a high degree of reliability or safety should employ suitable designs or other safeguards (such as installation of protective circuitry or redundancies) in order to ensure that the failure of an electrical component does not result in a risk of personal injury or property damage.

Although all product-related warnings, cautions and notes must be observed, the customer should not assume that all safety measures are indicated or that other measures may not be required.

Product & Process Design

Sales & Marketing

Supplier

Material Management

Quality

Manufacturing

Logistics & Distribution

People: Leadership
& Development

KEMET Production System

Corporate Offices

KEMET Corporation
2835 KEMET Way
Simpsonville, SC 29681
USA
Tel: 864.963.6300
Fax: 864.963.6521

KEMET Electronics S.A.
15bis chemin des Mines
1202 Geneva
Switzerland
Tel: 41.22.715.0100
Fax: 41.22.715.0170

KEMET Electronics Marketing (S) Pte Ltd.
73 Bukit Timah Road
#05-01 Rex House
Singapore 229832
Tel: 65.6586.1900
Fax: 65.6586.1901

www.kemet.com

The Capacitance Company
KEMET
CHARGED®