

CZRU52C2 Thru CZRU52C39 (RoHS Device)

Voltage 2 to 39 Volts
Power 150 mWatts



Features

- 150mW Power Dissipation.
- High Voltages from 2 ~ 39 V.
- Designed for mounting on small surface.
- Extremely thin/leadless package.
- Pb free product.

Mechanical data

- Case: 0603(1608)Standard package
Molded plastic.
- Terminals: Gold plated, solderable per
MIL-STD-750,method 2026.
- Polarity: Indicated by cathode band.
- Weight: 0.003 gram(approx.).

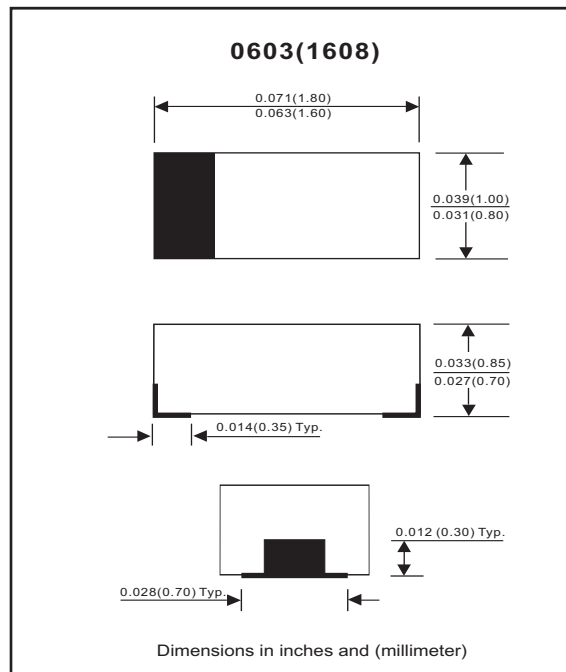

Maximum Rating AND Electrical Characteristics

Parameter	Symbol	Value	Unit
Maximum Forward Voltage Drop at $I_F = 10 \text{ mA}$	V_F	0.9	V
Maximum Power Dissipation at 25 °C	P_D	150	mW
Forward current , surge peak 8.3 ms single half sine-wave superimposed on rate load(JEDEC method)	I_{FSM}	2.0	A
Peak ESD voltage capability (IEC 61000-4-2)	V_{PV}	8	kV
Operating Junction and Storage Temperature Range	T_J	-55 to +125	°C

Electrical Characteristics(Ta = 25°C)

Part Number	Marking Code	Zener Voltage			Operating resistance		Rising operating Resistance		Reverse current	
		Vz(V)			ZZT(Ohm)		ZZK(Ohm)		IR(uA)	
		Min	Max	Iz(mA)	Max	Iz(mA)	Max	Iz(mA)	Max	VR(V)
CZRU52C2	Z0	1.90	2.10	5	100	5	600	1	100	1
CZRU52C2V2	Z1	2.09	2.31	5	100	5	600	1	100	1
CZRU52C2V4	Z2	2.28	2.52	5	85	5	600	1	100	1
CZRU52C2V7	Z3	2.57	2.84	5	83	5	500	1	75	1
CZRU52C3	Z4	2.85	3.15	5	95	5	500	1	50	1
CZRU52C3V3	Z5	3.14	3.47	5	95	5	500	1	25	1
CZRU52C3V6	Z6	3.42	3.78	5	95	5	500	1	15	1
CZRU52C3V9	Z7	3.71	4.10	5	95	5	500	1	10	1
CZRU52C4V3	Z8	4.09	4.52	5	95	5	500	1	5	1
CZRU52C4V7	Z9	4.47	4.94	5	78	5	500	1	5	2
CZRU52C5V1	ZA	4.85	5.36	5	60	5	480	1	0.1	0.8
CZRU52C5V6	ZB	5.32	5.88	5	40	5	400	1	0.1	1
CZRU52C6V2	ZC	5.89	6.51	5	10	5	200	1	0.1	2
CZRU52C6V8	ZE	6.46	7.14	5	8	5	150	1	0.1	3
CZRU52C7V5	ZF	7.13	7.88	5	7	5	50	1	0.1	5
CZRU52C8V2	ZG	7.79	8.61	5	7	5	50	1	0.1	6
CZRU52C9V1	ZH	8.65	9.56	5	10	5	50	1	0.1	7
CZRU52C10	ZJ	9.50	10.50	5	15	5	70	1	0.1	7.5
CZRU52C11	ZK	10.45	11.55	5	20	5	70	1	0.1	8.5
CZRU52C12	ZM	11.40	12.60	5	20	5	90	1	0.1	9
CZRU52C13	ZN	12.35	13.65	5	25	5	110	1	0.1	10
CZRU52C15	ZP	14.25	15.75	5	30	5	110	1	0.1	11
CZRU52C16	ZQ	15.20	16.80	5	40	5	170	1	0.1	12
CZRU52C18	ZR	17.10	18.90	5	50	5	170	1	0.1	14
CZRU52C20	ZS	19.00	21.00	5	50	5	220	1	0.1	15
CZRU52C22	ZT	20.90	23.10	5	55	5	220	1	0.1	17
CZRU52C24	ZU	22.80	25.20	5	80	5	220	1	0.1	18
CZRU52C27	ZV	25.65	28.35	5	80	5	250	1	0.1	20
CZRU52C30	ZW	28.50	31.50	5	80	5	250	1	0.1	23
CZRU52C33	ZX	31.35	34.65	5	80	5	250	1	0.1	25
CZRU52C36	ZY	34.20	37.80	5	90	5	250	1	0.1	27
CZRU52C39	ZZ	37.05	40.95	5	90	5	300	1	0.1	29

RATING AND CHARACTERISTIC CURVES (CZRU52C2 Thru CZRU52C39)

Fig.1 TEMPERATURE COEFFICIENTS

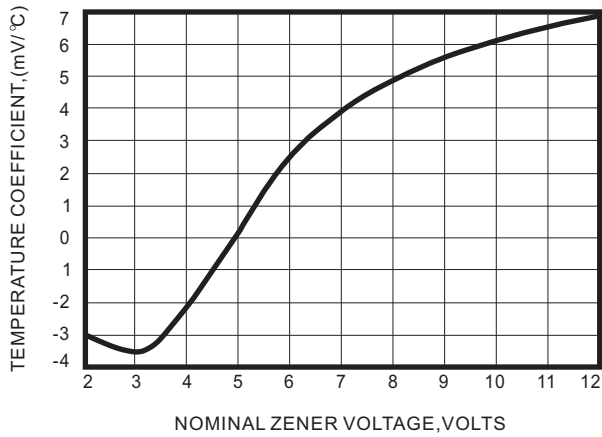

Fig.2 TEMPERATURE COEFFICIENTS

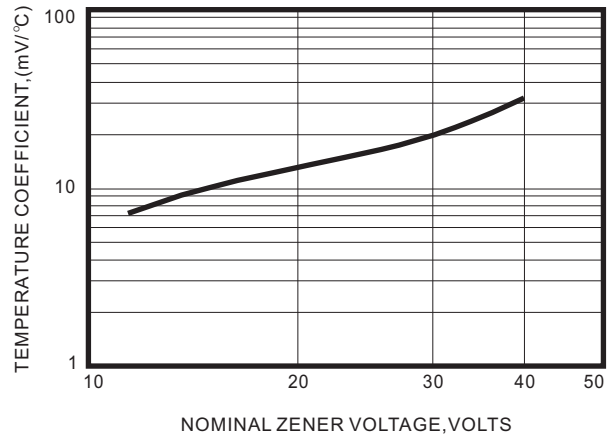

Fig.3 EFFECT OF ZENER VOLTAGE ON ZENER IMPEDANCE

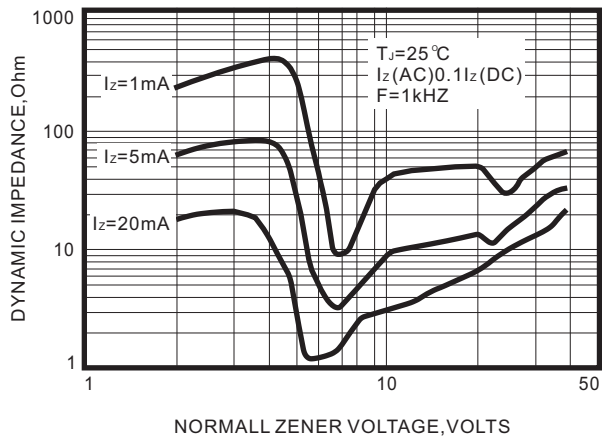

Fig.4 TYPICAL FORWARD VOLTAGE

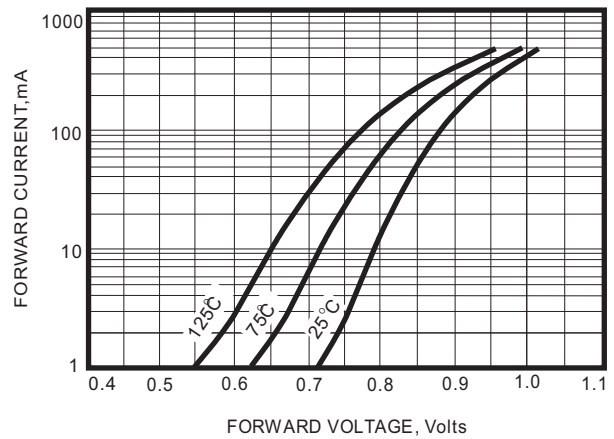

Fig.5 TYPICAL LEAKAGE CURRENT

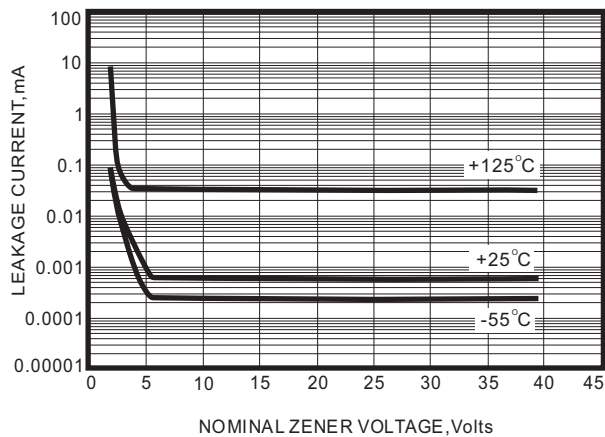
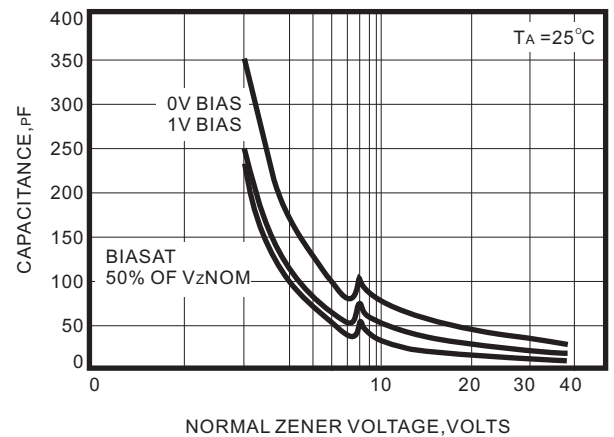

Fig.6 TYPICAL CAPACITANCE



RATING AND CHARACTERISTIC CURVES (CZRU52C2 Thru CZRU52C39)

Fig.7 ZENER VOLTAGE VERSUS ZENER CURRENT

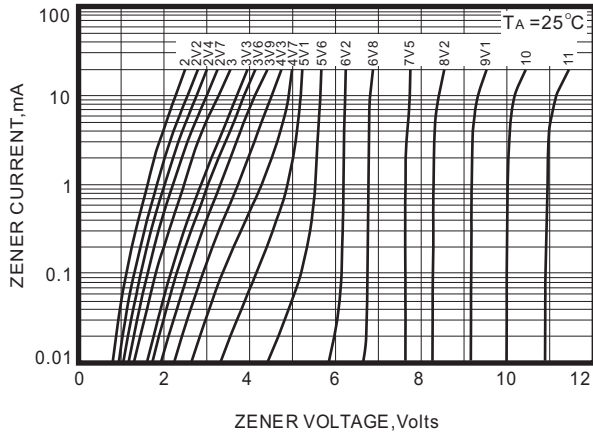

Fig.8 ZENER VOLTAGE VERSUS ZENER CURRENT

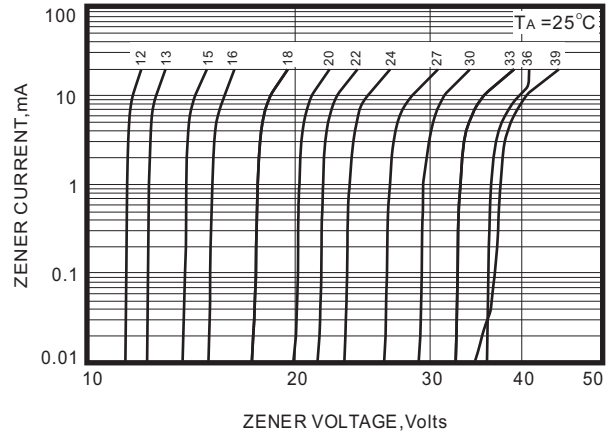
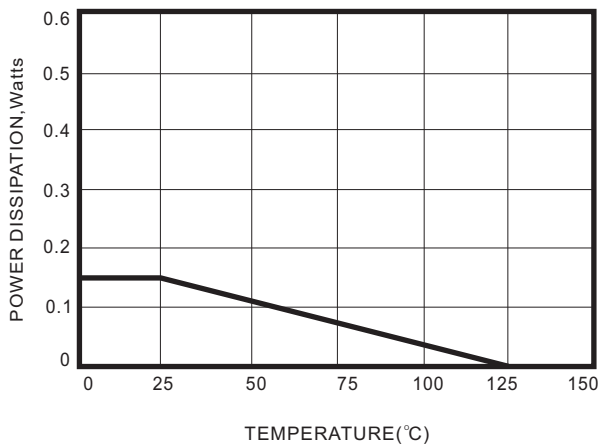
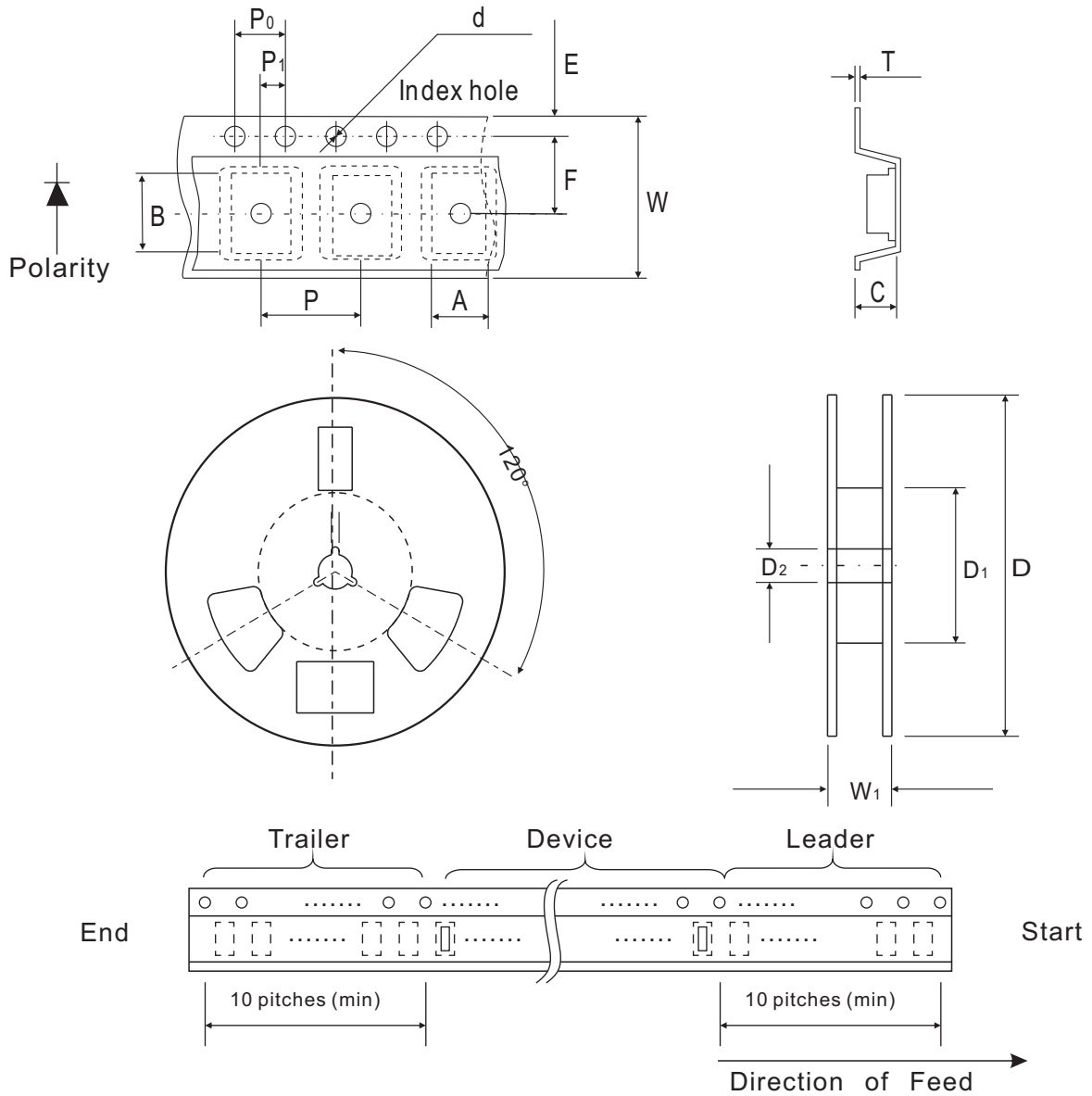

Fig.9 STEADY STATE POWER DERATING



Reel Taping Specification



U/0603	SYMBOL	A	B	C	d	D	D ₁	D ₂
	(mm)	1.00 ± 0.10	1.85 ± 0.10	1.00 ± 0.10	1.55 ± 0.05	178 ± 1	60.0 MIN.	13.0 ± 0.20
	(inch)	0.039 ± 0.004	0.073 ± 0.004	0.039 ± 0.004	0.061 ± 0.002	7.008 ± 0.04	2.362 MIN.	0.512 ± 0.008

U/0603	SYMBOL	E	F	P	P ₀	P ₁	T	W	W ₁
	(mm)	1.75 ± 0.10	3.50 ± 0.05	4.00 ± 0.10	4.00 ± 0.10	2.00 ± 0.05	0.23 ± 0.05	8.00 ± 0.20	13.5 MAX.
	(inch)	0.069 ± 0.004	0.138 ± 0.002	0.157 ± 0.004	0.157 ± 0.004	0.079 ± 0.004	0.009 ± 0.002	0.315 ± 0.008	0.531 MAX.

Suggested PAD Layout

SIZE	U/0603	
	(mm)	(inch)
A	1.70	0.067
B	0.60	0.024
C	0.80	0.031
D	2.30	0.091
E	1.10	0.043

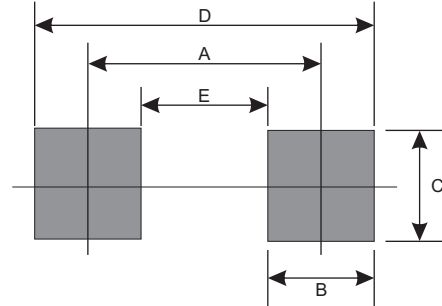

Standard Package

Case Type	Qty per Reel	Reel Size
	(Pcs)	(inch)
U/0603	4000	7