

Features

- Low Forward Voltage Drop
- Fast Switching
- Ultra-Small Surface Mount Package
- PN Junction Guard Ring for Transient and ESD Protection
- **Lead Free/RoHS Compliant (Note 2)**
- **Qualified to AEC-Q101 Standards for High Reliability**
- **"Green" Device (Note 3 and 4)**

Mechanical Data

- Case: SOT-323
- Case Material: Molded Plastic, "Green" Molding Compound, Note 5. UL Flammability Classification Rating 94V-0
- Moisture Sensitivity: Level 1 per J-STD-020D
- Terminals: Solderable per MIL-STD-202, Method 208
- Lead Free Plating (Matte Tin Finish annealed over Alloy 42 leadframe).
- Polarity: See Diagrams Below
- Marking Information: See Page 3
- Ordering Information: See Page 3
- Weight: 0.006 grams (approximate)



Top View

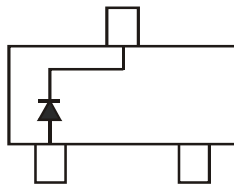

BAT54W-KL5

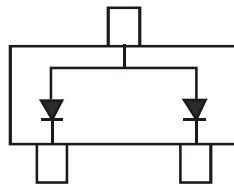

BAT54AW-KL6

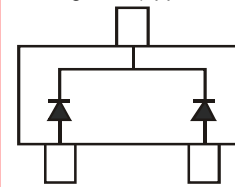

BAT54CW-KL7

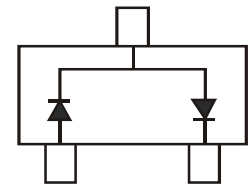

BAT54SW-KL8

25-07334

25-05599

Maximum Ratings @ $T_A = 25^\circ\text{C}$ unless otherwise specified

| Characteristic | Symbol | Value | Unit |
|--|---------------------|-------|------|
| Peak Repetitive Reverse Voltage | V_{RRM} | 30 | V |
| Working Peak Reverse Voltage | V_{RWM} | | |
| DC Blocking Voltage | V_R | | |
| Forward Continuous Current (Note 1) | I_F | 200 | mA |
| Repetitive Peak Forward Current (Note 1) | I_{FRM} | 300 | mA |
| Forward Surge Current (Note 1) | I_{FSM} | 600 | mA |
| | @ $t < 1.0\text{s}$ | | |

Thermal Characteristics

| Characteristic | Symbol | Value | Unit |
|---|-----------------|-------------|---------------------------|
| Power Dissipation (Note 1) | P_D | 200 | mW |
| Thermal Resistance Junction to Ambient Air (Note 1) | $R_{\theta JA}$ | 625 | $^\circ\text{C}/\text{W}$ |
| Operating and Storage Temperature Range | T_J, T_{STG} | -65 to +125 | $^\circ\text{C}$ |

- Notes:
1. Mounted on FR-4 PC board with recommended pad layout which can be found on our website at <http://www.diodes.com/datasheets/ap02001.pdf>.
 2. No purposefully added lead.
 3. Diodes Inc.'s "Green" policy can be found on our website at http://www.diodes.com/products/lead_free/index.php.
 4. Product manufactured with Date Code 0627 (week 27, 2006) and newer are built with Green Molding Compound. Product manufactured prior to Date Code 0627 are built with Non-Green Molding Compound and may contain Halogens or Sb2O3 Fire Retardants.

Electrical Characteristics @T_A = 25°C unless otherwise specified

| Characteristic | Symbol | Min | Typ | Max | Unit | Test Condition |
|------------------------------------|--------------------|-----|-----|----------------------------------|------|--|
| Reverse Breakdown Voltage (Note 5) | V _{(BR)R} | 30 | — | — | V | I _R = 100μA |
| Forward Voltage | V _F | — | — | 240 320 400 500 1000 | mV | I _F = 0.1mA I _F = 1mA I _F = 10mA I _F = 30mA I _F = 100mA |
| Reverse Leakage Current (Note 5) | I _R | — | — | 2.0 | μA | V _R = 25V |
| Total Capacitance | C _T | — | — | 10 | pF | V _R = 1.0V, f = 1.0MHz |
| Reverse Recovery Time | t _{rr} | — | — | 5.0 | ns | I _F = 10mA through I _R = 10mA to I _R = 1.0mA, R _L = 100Ω |

Notes: 5. Short duration pulse test used to minimize self-heating effect.

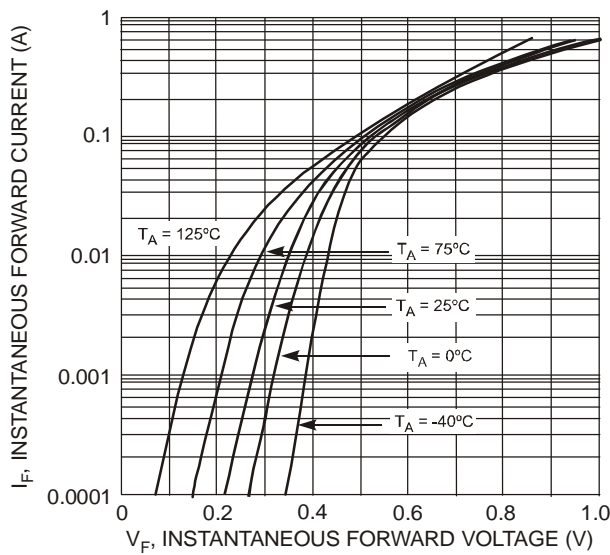

Fig. 1 Typical Forward Characteristics

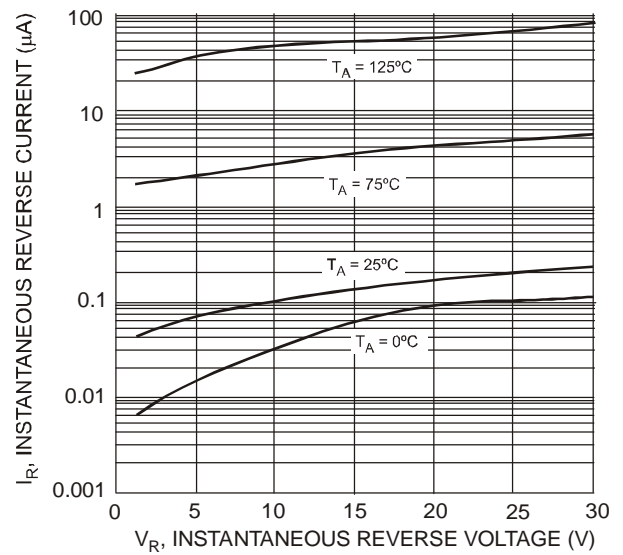

Fig. 2 Typical Reverse Characteristics

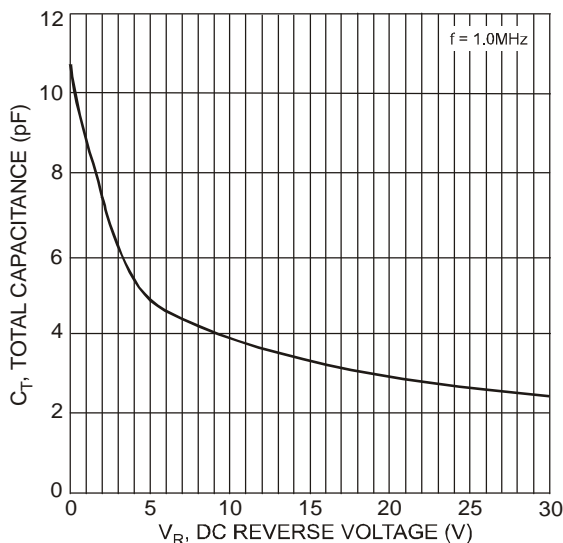

Fig. 3 Total Capacitance vs. Reverse Voltage

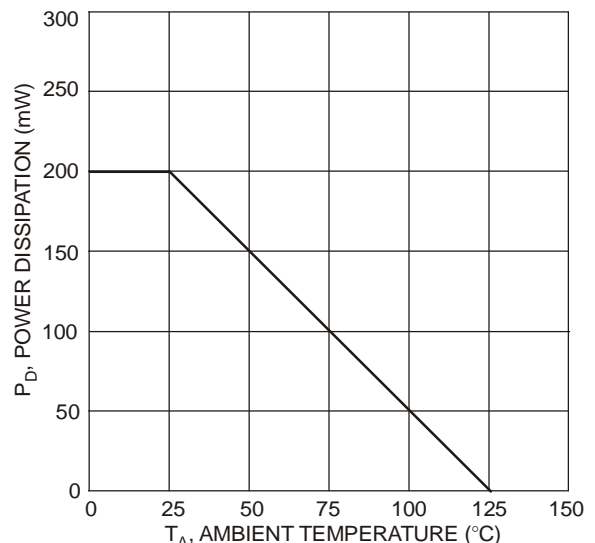

Fig. 4 Power Derating Curve

Ordering Information (Note 4 & 6)

| Part Number | Case | Packaging |
|-------------|---------|------------------|
| BAT54W-7-F | SOT-323 | 3000/Tape & Reel |
| BAT54AW-7-F | SOT-323 | 3000/Tape & Reel |
| BAT54CW-7-F | SOT-323 | 3000/Tape & Reel |
| BAT54SW-7-F | SOT-323 | 3000/Tape & Reel |

Notes: 6. For packaging details, go to our website at <http://www.diodes.com/datasheets/ap02007.pdf>.

Marking Information

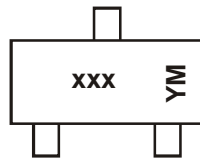

xxx = Product Type Marking Code
 KL5 = BAT54W
 KL6 = BAT54AW
 KL7 = BAT54CW
 KL8 = BAT54SW
 YM = Date Code Marking
 Y = Year (ex: N = 2002)
 M = Month (ex: 9 = September)

Date Code Key

| Year | 2000 | 2001 | 2002 | 2003 | 2004 | 2005 | 2006 | 2007 | 2008 | 2009 | 2010 | 2011 | 2012 | 2013 | 2014 | 2015 |
|------|------|------|------|------|------|------|------|------|------|------|------|------|------|------|------|------|
| Code | L | M | N | P | R | S | T | U | V | W | X | Y | Z | A | B | C |

| Month | Jan | Feb | Mar | Apr | May | Jun | Jul | Aug | Sep | Oct | Nov | Dec |
|-------|-----|-----|-----|-----|-----|-----|-----|-----|-----|-----|-----|-----|
| Code | 1 | 2 | 3 | 4 | 5 | 6 | 7 | 8 | 9 | O | N | D |

Package Outline Dimensions

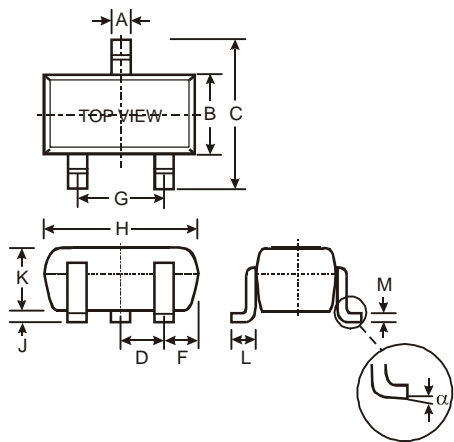

| SOT-323 | | | |
|----------|------|------|-------|
| Dim | Min | Max | Typ |
| A | 0.25 | 0.40 | 0.30 |
| B | 1.15 | 1.35 | 1.30 |
| C | 2.00 | 2.20 | 2.10 |
| D | - | - | 0.65 |
| F | 0.30 | 0.40 | 0.425 |
| G | 1.20 | 1.40 | 1.30 |
| H | 1.80 | 2.20 | 2.15 |
| J | 0.0 | 0.10 | 0.05 |
| K | 0.90 | 1.00 | 1.00 |
| L | 0.25 | 0.40 | 0.30 |
| M | 0.10 | 0.18 | 0.11 |
| α | 0° | 8° | - |

All Dimensions in mm

Suggested Pad Layout

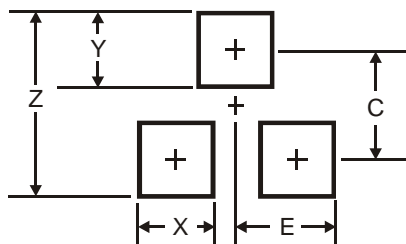

| Dimensions | Value (in mm) |
|------------|---------------|
| Z | 2.8 |
| X | 0.7 |
| Y | 0.9 |
| C | 1.9 |
| E | 1.0 |

IMPORTANT NOTICE

Diodes Incorporated and its subsidiaries reserve the right to make modifications, enhancements, improvements, corrections or other changes without further notice to any product herein. Diodes Incorporated does not assume any liability arising out of the application or use of any product described herein; neither does it convey any license under its patent rights, nor the rights of others. The user of products in such applications shall assume all risks of such use and will agree to hold Diodes Incorporated and all the companies whose products are represented on our website, harmless against all damages.

LIFE SUPPORT

Diodes Incorporated products are not authorized for use as critical components in life support devices or systems without the expressed written approval of the President of Diodes Incorporated.