

650mA/350mA Micropower Low Noise Boost Converter with Output Disconnect

25-05506

FEATURES

- Low Quiescent Current
60 μ A in Active Mode
0.1 μ A in Shutdown Mode
- Low Noise Control Scheme (Switching Frequency Always Stays Above Audible Range for LT3495/-1)
- Integrated Power NPN:
650mA Current Limit (LT3495/B)
350mA Current Limit (LT3495-1/B-1)
- Integrated Output Disconnect
- Integrated Output Dimming
- Wide input range: 2.5V to 16V
- Wide output range: Up to 40V
- Integrated feedback resistor
- Tiny 10-Lead 3mm \times 2mm DFN Package

APPLICATIONS

- OLED Power
- Low Noise Power
- MP3 Player

DESCRIPTION

The LT[®]3495/LT3495B/LT3495-1/LT3495B-1 are low noise boost converters with integrated power switch, feedback resistor and output disconnect circuitry. The parts control power delivery by varying both the peak inductor current and switch off-time. This novel* control scheme results in low output voltage ripple as well as high efficiency over a wide load range. For the LT3495/LT3495-1, the off-time of the switch is not allowed to exceed a fixed level, guaranteeing the switching frequency stays above the audio band for the entire load range. The parts feature a high performance NPN power switch with a 650mA and 350mA current limit for the LT3495/LT3495B and LT3495-1/LT3495B-1 respectively. The quiescent current is a low 60 μ A, which is further reduced to less than 0.1 μ A in shutdown. The internal disconnect circuitry allows the output voltage to be isolated from the input during shutdown. An auxiliary reference input (CTRL pin) overrides the internal 1.235V feedback reference with any lower value allowing full control of the output voltage during operation. The LT3495 series are available in a tiny 10-lead 3mm \times 2mm DFN package.

LT, LT, LTC and LTM are registered trademarks of Linear Technology Corporation. All other trademarks are the property of their respective owners. *Patent pending.

TYPICAL APPLICATION

OLED Power Supply from One Li-Ion Cell

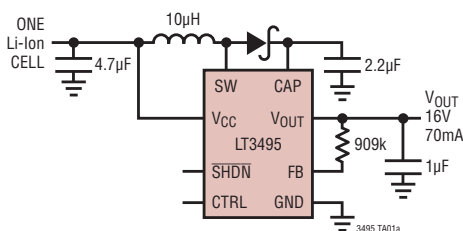

Output Voltage Ripple
vs Load Current

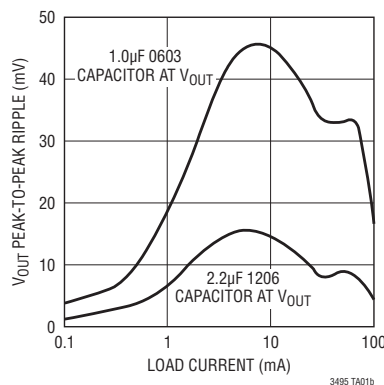

Efficiency vs Load Current

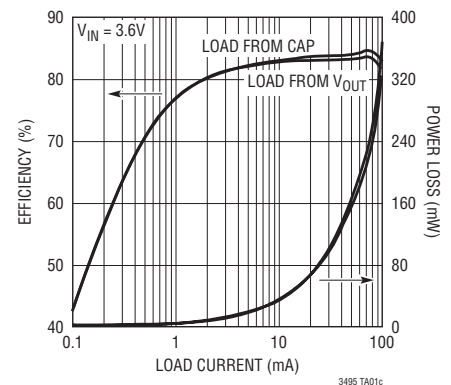

3495b1b1fa

LT3495/LT3495B/ LT3495-1/LT3495B-1

ABSOLUTE MAXIMUM RATINGS

(Note 1)

V_{CC} Voltage	16V
SW Voltage	40V
CAP Voltage	40V
V_{OUT} Voltage	40V
SHDN Voltage	10V
CTRL Voltage	10V
FB Voltage	2.5V
Maximum Junction Temperature.....	125°C
Operating Temperature Range (Note 2)...	-40°C to 125°C
Storage Temperature Range.....	-65°C to 150°C

PIN CONFIGURATION

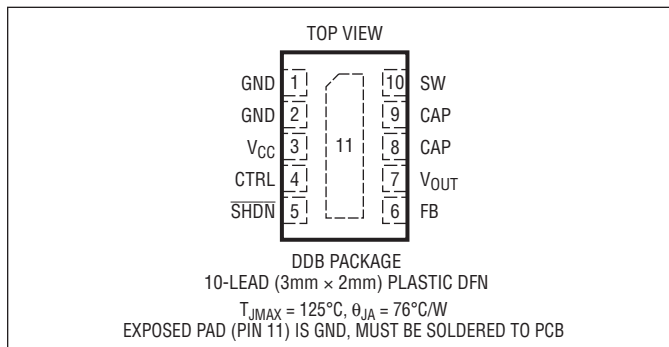

ORDER INFORMATION

LEAD FREE FINISH	TAPE AND REEL	PART MARKING	PACKAGE DESCRIPTION	TEMPERATURE RANGE
LT3495EDDB#PBF	LT3495EDDB#TRPBF	LDSS	10-Lead (3mm × 2mm) Plastic DFN	-40°C to 125°C
LT3495EDDB-1#PBF	LT3495EDDB-1#TRPBF	LDSV	10-Lead (3mm × 2mm) Plastic DFN	-40°C to 125°C
LT3495BEDDB#PBF	LT3495BEDDB#TRPBF	LDST	10-Lead (3mm × 2mm) Plastic DFN	-40°C to 125°C
LT3495BEDDB-1#PBF	LT3495BEDDB-1#TRPBF	LDSW	10-Lead (3mm × 2mm) Plastic DFN	-40°C to 125°C

Consult LTC Marketing for parts specified with wider operating temperature ranges.

Consult LTC Marketing for information on non-standard lead based finish parts.

For more information on lead free part marking, go to: <http://www.linear.com/leadfree/>

For more information on tape and reel specifications, go to: <http://www.linear.com/tapeandreeel/>

ELECTRICAL CHARACTERISTICS

The ● denotes the specifications which apply over the full operating temperature range, otherwise specifications are at $T_A = 25^\circ\text{C}$. $V_{CC} = 3\text{V}$, $V_{SHDN} = V_{CC}$, unless otherwise noted. (Note 2)

PARAMETER	CONDITIONS	MIN	TYP	MAX	UNITS
Minimum Operating Voltage			2.2	2.5	V
Maximum Operating Voltage				16	V
FB Voltage	$V_{CTRL} = 3\text{V}$, (Note 3)	● 1.220	1.235	1.255	V
FB Voltage Line Regulation			0.03		%/V
FB Resistor	FB Voltage = 1.235V	● 74.7	76	77	k Ω
Quiescent Current	Not Switching		60	70	μA
Quiescent Current in Shutdown	$V_{SHDN} = 0\text{V}$, $V_{CC} = 3\text{V}$		0	1	μA
Minimum Switch-Off Time	After Start-Up (Note 4) During Start-Up (Note 4)		200 500		ns ns
Maximum Switch-Off Time	LT3495/LT3495-1, $V_{FB} = 1.5\text{V}$	● 17	26	35	μs
Maximum Switch-On Time			10		μs
Switch Current Limit	LT3495/LT3495B	● 550	650	780	mA

3495b1b1fa

ELECTRICAL CHARACTERISTICS

The ● denotes the specifications which apply over the full operating temperature range, otherwise specifications are at $T_A = 25^\circ\text{C}$. $V_{CC} = 3\text{V}$, $V_{SHDN} = V_{CC}$, unless otherwise noted. (Note 2)

PARAMETER	CONDITIONS		MIN	TYP	MAX	UNITS
Switch Current Limit	LT3495-1/LT3495B-1	●	275	350	450	mA
Switch V_{CESAT}	LT3495/LT3495B, $I_{SW} = 400\text{mA}$ LT3495-1/LT3495B-1, $I_{SW} = 200\text{mA}$			200 125		mV mV
Switch Leakage Current	$V_{SW} = 5\text{V}$			0.01	1	μA
PMOS Disconnect Current Limit	After Start-Up During Start-Up		250 110	370 150	450 190	mA mA
PMOS Disconnect $V_{CAP} - V_{OUT}$	$I_{OUT} = 50\text{mA}$, $V_{CAP} = 15\text{V}$			150		mV
$V_{CAP} - V_{OUT}$ Clamp Voltage				8.7		V
SHDN Input Voltage High			1.5			V
SHDN Input Voltage Low					0.3	V
SHDN Pin Bias Current	$V_{SHDN} = 3\text{V}$ $V_{SHDN} = 0\text{V}$			5.3 0	8	μA μA
CTRL Pin Bias Current	$V_{CTRL} = 0.5\text{V}$, Current Flows Out of Pin	●		20	100	nA
CTRL to FB Offset	$V_{CTRL} = 0.5\text{V}$			6	14	mV
Maximum Shunt Current	LT3495/LT3495-1, $V_{FB} = 1.5\text{V}$			230		μA

Note 1: Stresses beyond those listed under Absolute Maximum Ratings may cause permanent damage to the device. Exposure to any Absolute Maximum Rating condition for extended periods may affect device reliability and lifetime.

Note 2: The LT3495/LT3495B/LT3495-1/LT3495B-1 are guaranteed to meet performance specifications from 0°C to 125°C junction temperature. Specifications over the -40°C to 125°C operating junction temperature range are assured by design, characterization and correlation with statistical process controls.

Note 3: Internal reference voltage is determined by finding V_{FB} voltage level which causes quiescent current to increase $150\mu\text{A}$ above "Not Switching" level.

Note 4: If CTRL is overriding the internal reference, Start-Up mode occurs when V_{FB} is less than half the voltage on CTRL. If CTRL is not overriding the internal reference, Start-Up mode occurs when V_{FB} is less than half the voltage of the internal reference.

TYPICAL PERFORMANCE CHARACTERISTICS $T_A = 25^\circ\text{C}$ unless otherwise noted.

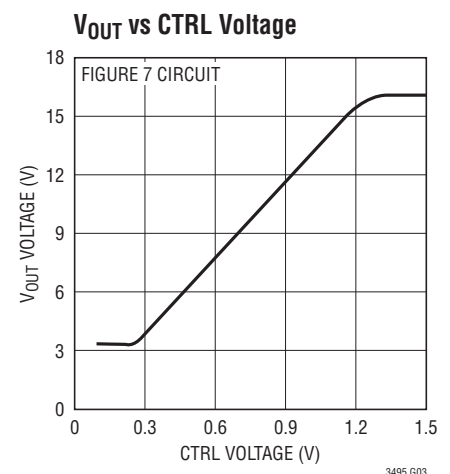
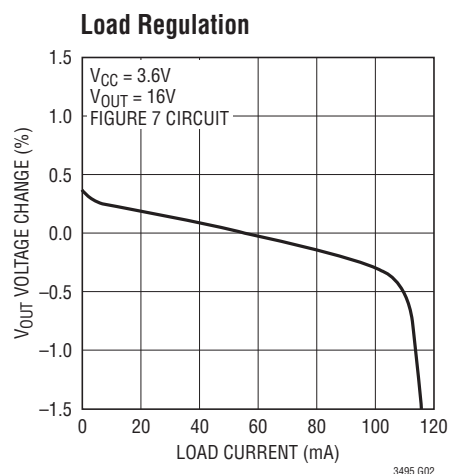
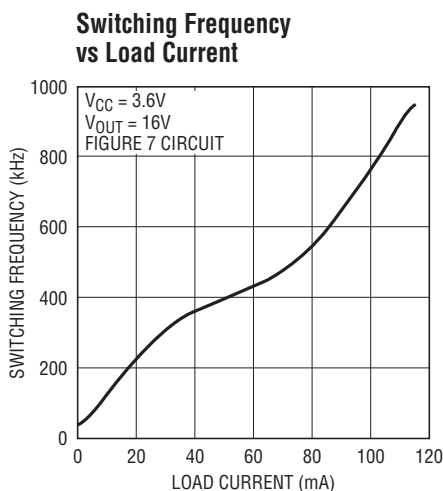

TYPICAL PERFORMANCE CHARACTERISTICS $T_A = 25^\circ\text{C}$ unless otherwise noted.

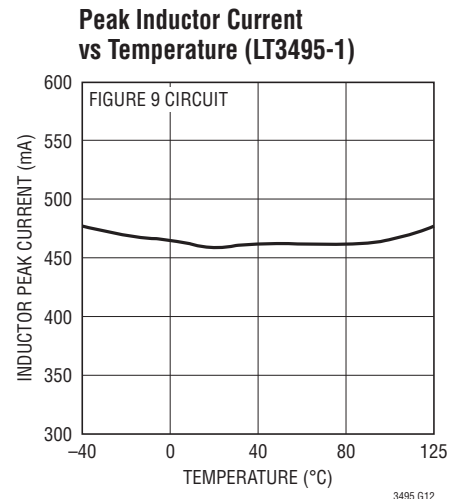
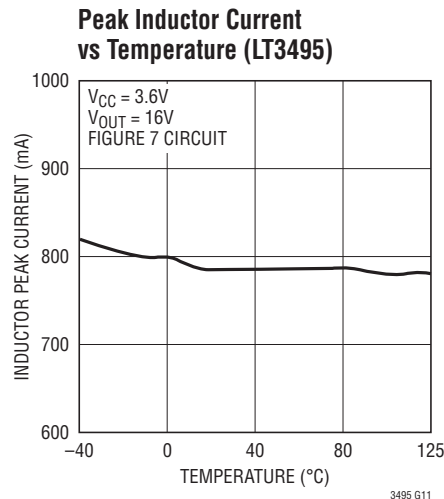
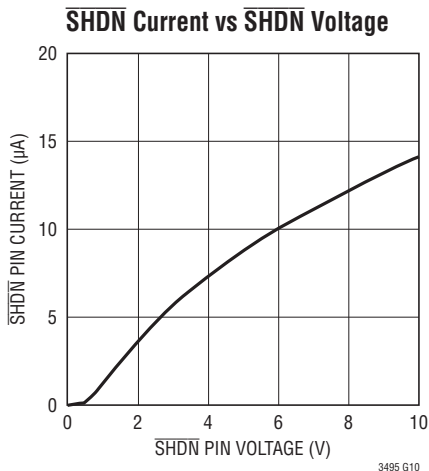
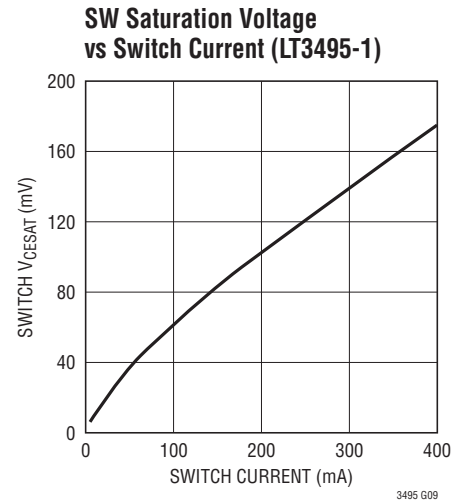
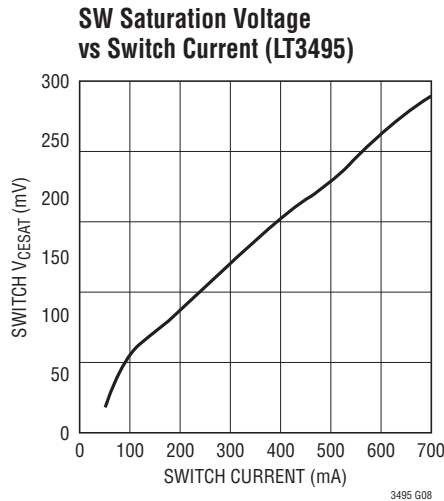
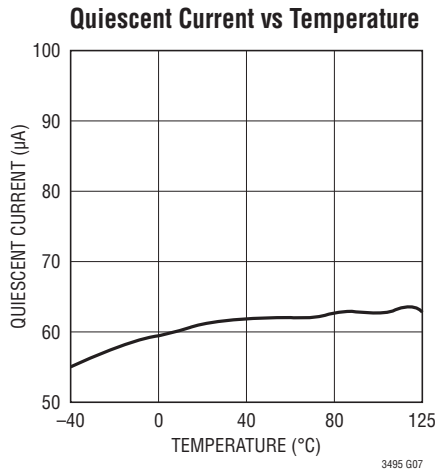
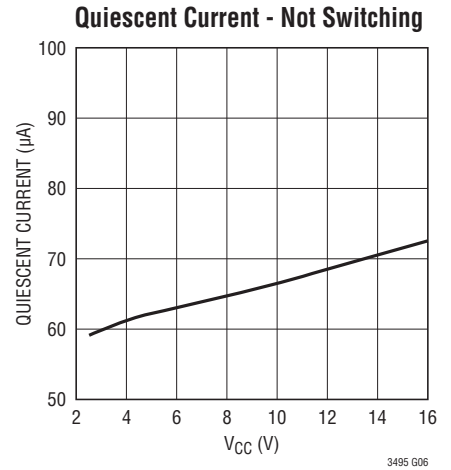
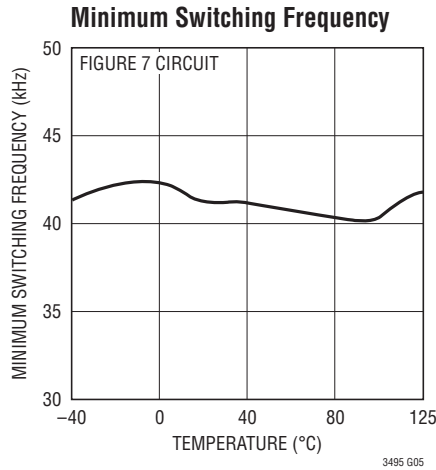
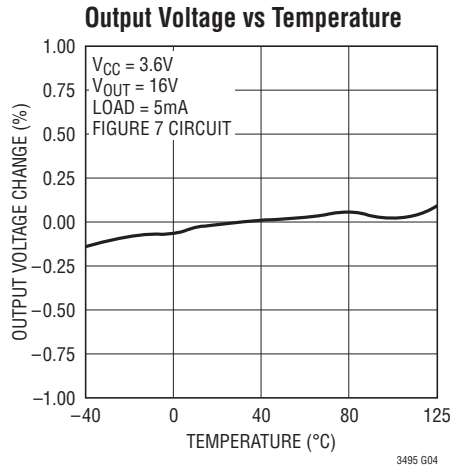

TYPICAL PERFORMANCE CHARACTERISTICS $T_A = 25^\circ\text{C}$ unless otherwise noted.

**LT3495 Switching Waveform
at No Load**

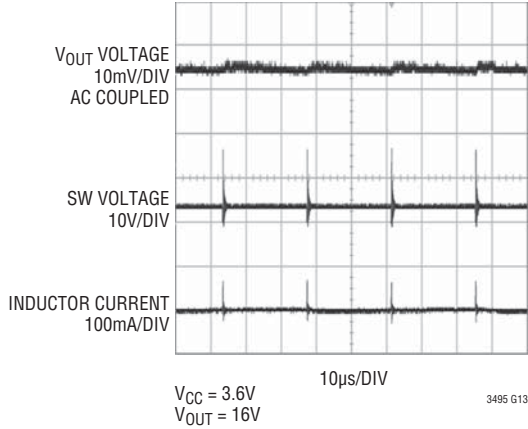

**LT3495 Switching Waveform
at 10mA**

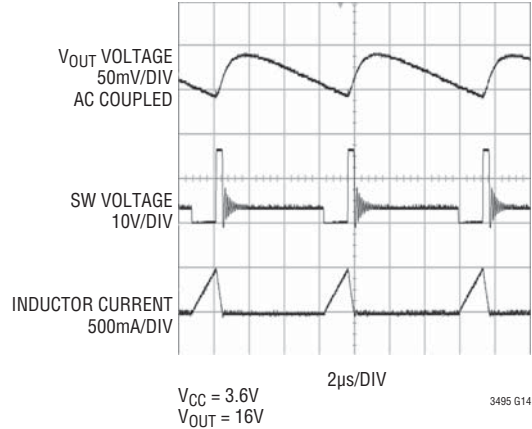

**LT3495 Switching Waveform
at 80mA**

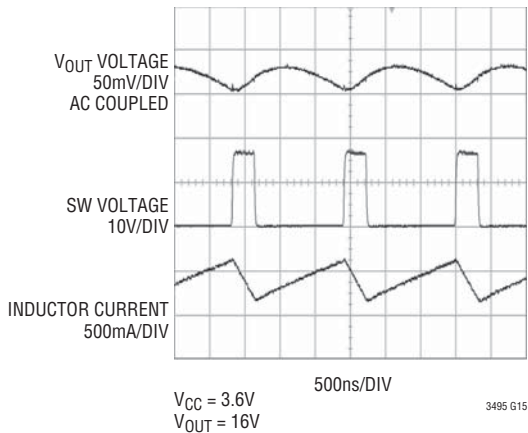

**LT3495B-1 Switching Waveform
at No Load**

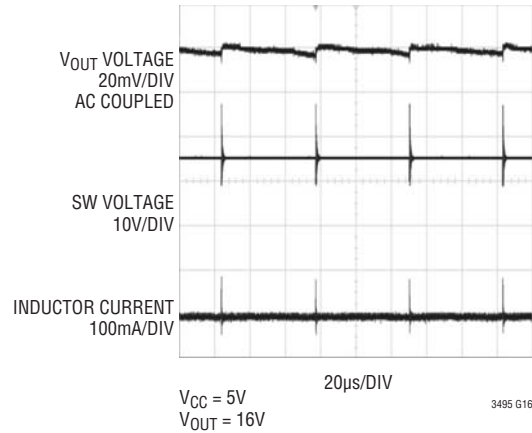

**LT3495B-1 Switching Waveform
at 10mA**

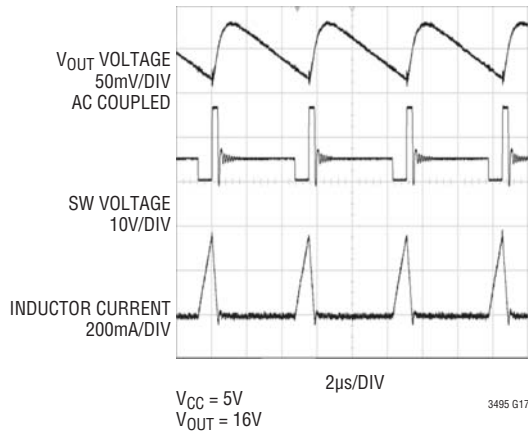

**LT3495B-1 Switching Waveform
at 60mA**

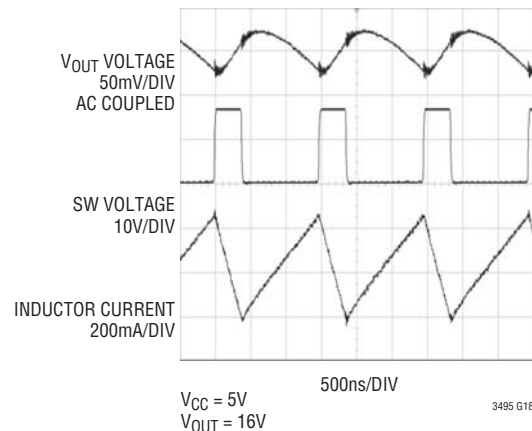

LT3495/LT3495B/ LT3495-1/LT3495B-1

TYPICAL PERFORMANCE CHARACTERISTICS $T_A = 25^\circ\text{C}$ unless otherwise noted.

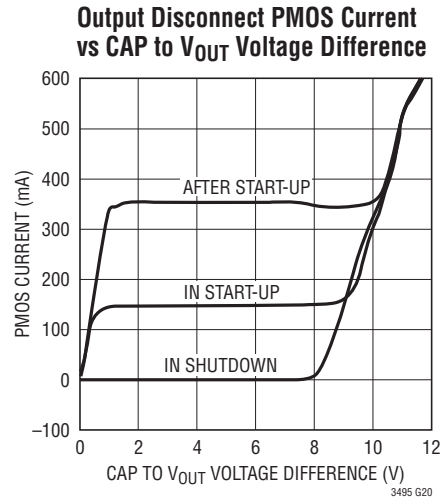
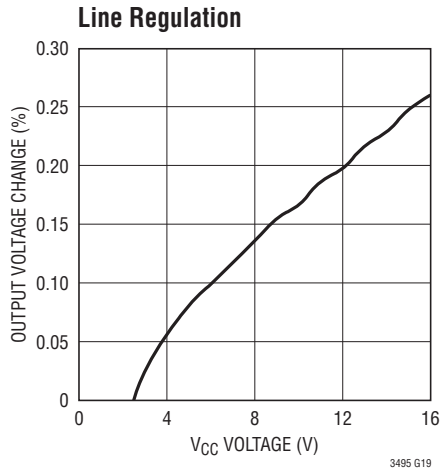

LT3495 Start-Up Waveforms

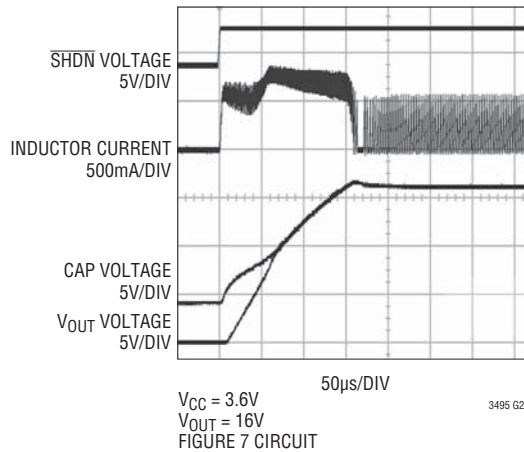

LT3495 Transient Response

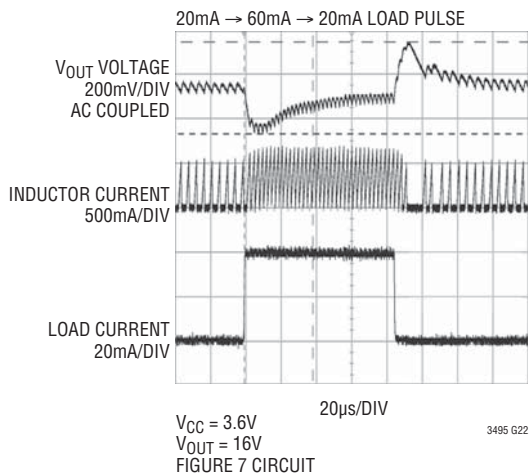

LT3495-1 Transient Response

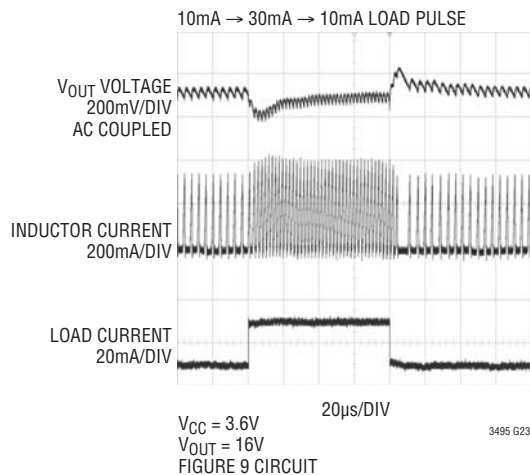

3495b1b1fa

PIN FUNCTIONS

GND (Pins 1, 2): Ground. Tie directly to local ground plane.

V_{CC} (Pin 3): Input Supply Pin. Must be locally bypassed.

CTRL (Pin 4): Dimming Pin. If not used, tie CTRL to 1.5V or higher. If in use, drive CTRL below 1.235V to override the internal reference. See Applications section for more information.

SHDN (Pin 5): Shutdown Pin. Tie to 1.5V or more to enable chip. Ground to shut down.

FB (Pin 6): Feedback Pin. Minimize the metal trace area to this pin to minimize noise. Reference voltage is 1.235V. There is an internal 76k resistor from the FB pin to GND. To

achieve the desired output voltage, choose R1 according to the following formula:

$$R1 = 76 \cdot (V_{OUT}/1.235 - 1)k\Omega$$

V_{OUT} (Pin 7): Drain of Output Disconnect PMOS. Place a bypass capacitor from this pin to GND. See Applications information.

CAP (Pins 8, 9): Source of Output Disconnect PMOS. Place a bypass capacitor from this pin to GND.

SW (Pin 10): Switch Pin. This is the collector of the internal NPN power switch. Minimize the metal trace area connected to this pin to minimize EMI.

Exposed Pad (Pin 11): Ground. This pin must be soldered to PCB.

BLOCK DIAGRAM

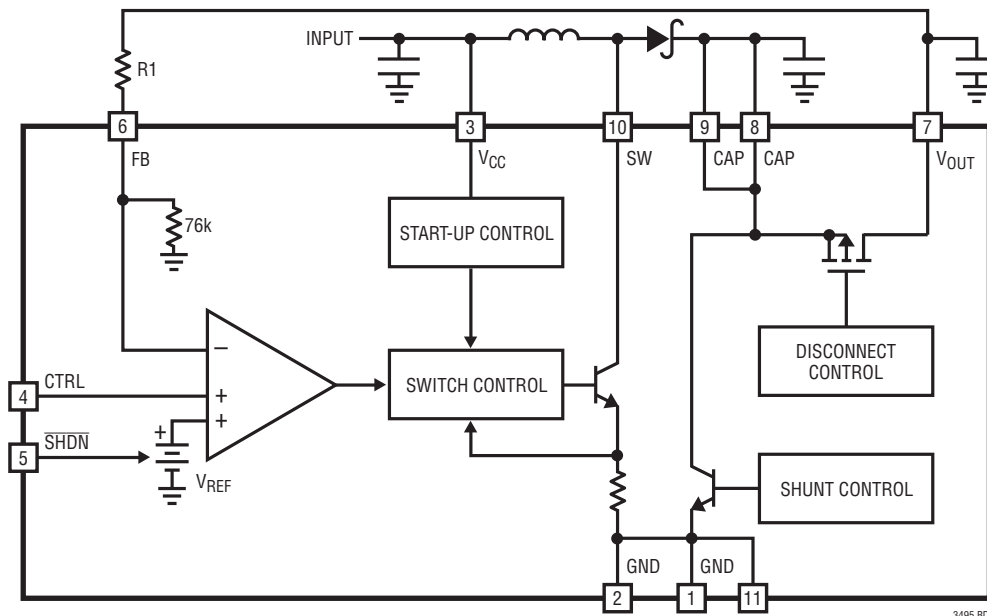

OPERATION

The LT3495 series utilizes a variable peak current, variable off-time control scheme to provide high efficiency over a wide range of output current.

The operation of the part can be better understood by referring to the Block Diagram. The part senses the output voltage by monitoring the voltage on the FB pin. The user sets the desired output voltage by choosing the value of the external top feedback resistor. The parts incorporate a precision 76k bottom feedback resistor. Assuming that output voltage adjustment is not used (CTRL pin is tied to 1.5V or greater), the internal reference ($V_{REF} = 1.235V$) sets the voltage at which FB will servo to during regulation.

The Switch Control block senses the output of the amplifier and adjusts the switching frequency as well as other parameters to achieve regulation. During the start-up of the circuit, special precautions are taken to ensure that the inductor current remains under control.

For the LT3495/LT3495-1, the switching frequency is never allowed to fall below approximately 45kHz. Because of this, a minimum load must be present to prevent the output voltage from drifting too high. For most applications, this minimum load is automatically generated within the part via the Shunt Control block. The level of this current is adaptable, removing itself when not needed to improve efficiency at higher load levels. However when the input

voltage and output voltage are close, the internal shunt current may not be large enough. Under this condition, a minimum output load is required to prevent the output voltage from drifting too high.

For the LT3495B/B-1, the minimum switching frequency feature is disabled and the switching frequency can be as low as zero. As a result, the output voltage will never drift high and no minimum output load is required.

The LT3495 series also has a PMOS output disconnect switch. The PMOS switch is turned on when the part is enabled via the \overline{SHDN} pin. When the parts are in shutdown, the PMOS switch turns off, allowing the V_{OUT} node to go to ground. This type of disconnect function is often required in power supplies.

The LT3495 series also sets a maximum switch on time of 10 μ s. This feature guarantees that the parts can continue to deliver energy to the output even if the input supply impedance becomes so large that the commanded peak switch current is never reached.

The difference between the LT3495/LT3495B and LT3495-1/LT3495B-1 is the level of the current limit. LT3495/LT3495B have a typical peak current limit of 650mA while the LT3495-1/LT3495B-1 have a typical peak current limit of 350mA. The differences between the LT3495 and LT3495B/LT3495-1/LT3495B-1 are listed in Table 1.

Table 1. Difference Between LT3495 and LT3495B/LT3495-1/LT3495B-1

PART	SWITCH CURRENT LIMIT (mA)	MINIMUM SWITCHING FREQUENCY (kHz)	MINIMUM OUTPUT LOAD REQUIREMENT
LT3495	650	45	Required under certain conditions
LT3495B	650	0	Not Required
LT3495-1	350	45	Required under certain conditions
LT3495B-1	350	0	Not Required

APPLICATIONS INFORMATION

Inductor Selection

Several inductors that work well with the LT3495/LT3495B are listed in Table 2 and those for the LT3495-1/LT3495B-1 are listed in Table 3. These tables are not complete, and there are many other manufacturers and devices that can be used. Consult each manufacturer for more detailed information and for their entire selection of related parts, as many different sizes and shapes are available.

Inductors with a value of 3.3μH or higher are recommended for most LT3495 series designs. Inductors with low core losses and small DCR (copper wire resistance) are good choices for LT3495 series applications. For full output power, the inductor should have a saturation current rating higher than the peak inductor current. The peak inductor current can be calculated as:

$$I_{PK} = I_{LIMIT} + \frac{V_{IN} \cdot 200 \cdot 10^{-9}}{L} \text{ amps}$$

where I_{LIMIT} is 0.65A and 0.35A for LT3495/LT3495B and LT3495-1/LT3495B-1 respectively. L is the inductance value in Henrys and V_{IN} is the input voltage to the boost circuit.

Table 2. Recommended Inductors for LT3495/LT3495B

PART	L (μH)	DCR (mΩ)	SIZE (mm)	VENDOR
LPS4018-103ML	10	200	4.4 × 4.4 × 1.7	Coilcraft www.coilcraft.com
MSS5131-103MLC	10	83	5.1 × 5.1 × 3.1	
LPS3015-472MLC	4.7	200	3.0 × 3.0 × 1.5	
LPS3015-682MLC	6.8	300	3.0 × 3.0 × 1.5	
LQH43CN4R7M03	4.7	150	4.5 × 3.2 × 2.8	Murata www.murata.com
CR32-6R8	6.8	202	4.1 × 3.7 × 3.0	Sumida www.sumida.com
744031004	4.7	105	3.8 × 3.8 × 1.7	Würth Elektronik www.weonline.com

Capacitor Selection

The small size and low ESR of ceramic capacitors makes them suitable for most LT3495 series applications. X5R and X7R types are recommended because they retain their capacitance over wider voltage and temperature ranges than other types such as Y5V or Z5U. A 4.7μF

input capacitor and a 1μF to 10μF output capacitor are sufficient for most applications. Always use a capacitor with a sufficient voltage rating. Many capacitors rated at 1μF to 10μF, particularly 0603 case sizes, have greatly reduced capacitance when bias voltages are applied. Be sure to check actual capacitance at the desired output voltage. Generally a 0805 or 1206 size capacitor will be adequate. A 2.2μF capacitor placed on the CAP node is recommended to filter the inductor current while a 1μF to 10μF capacitor placed on the V_{OUT} node will give excellent transient response and stability. Table 4 shows a list of several capacitor manufacturers. Consult the manufacturers for more detailed information and for their entire selection of related parts.

Table 3. Recommended Inductors for LT3495-1/LT3495B-1

PART	L (μH)	DCR (mΩ)	SIZE (mm)	VENDOR
LPO4815-472MLC	4.7	150	4.8 × 4.8 × 1.5	Coilcraft www.coilcraft.com
LPO4815-682MLC	6.8	180	4.8 × 4.8 × 1.5	
LPO4815-103MLC	10	230	4.8 × 4.8 × 1.5	
LPS3008-472MLC	4.7	350	3.0 × 3.0 × 0.8	
LPS3008-682MLC	6.8	500	3.0 × 3.0 × 0.8	
LPS3008-103MLC	10	650	3.0 × 3.0 × 0.8	
LQH32CN4R7M53	4.7	150	3.2 × 2.5 × 1.6	Murata www.murata.com
LQH32CN100K33	10	300	3.2 × 2.5 × 2.0	
CDH28D09/S-6R2	6.2	369	3.3 × 3.0 × 1.0	Sumida www.sumida.com
744030004	4.7	290	3.5 × 3.3 × 1.0	Würth Elektronik www.weonline.com

Table 4. Recommended Ceramic Capacitor Manufacturers

MANUFACTURER	PHONE	WEBSITE
Taiyo Yuden	(408) 573-4150	www.t-yuden.com
AVX	(843) 448-9411	www.avxcorp.com
Murata	(814) 237-1431	www.murata.com
Kemet	(408) 986-0424	www.kemet.com
TDK	(847) 803-6100	www.tdk.com

Diode Selection

Schottky diodes, with their low forward voltage drops and fast switching speeds, are recommended for use with the LT3495 series. The Diodes Inc. B0540WS-7 is a very good choice. This diode is rated to handle an average forward current of 0.5A with 40V reverse breakdown.

APPLICATIONS INFORMATION

Setting Output Voltage and the Auxiliary Reference Input

The LT3495 series is equipped with both an internal 1.235V reference and an auxiliary reference input. This allows the user to select between using the built-in reference and supplying an external reference voltage. The voltage at the CTRL pin can be adjusted while the chip is operating to alter the output voltage for purposes such as display dimming or contrast adjustment. To use the internal 1.235V reference, the CTRL pin must be held higher than 1.5V. When the CTRL pin is held between 0V and 1.235V, the parts will regulate the output such that the FB pin voltage is nearly equal to the CTRL pin voltage. At CTRL voltages close to 1.235V, a soft transition occurs between the CTRL pin and the internal reference. Figure 1 shows this behavior.

To set the maximum output voltage, select the values of R1 according to the following equation:

$$R1 = 76 \cdot \left(\frac{V_{OUT}}{1.235} - 1 \right) \text{k}\Omega$$

When CTRL is used to override the internal reference, the output voltage can be lowered from the maximum value down to nearly the input voltage level. If the voltage source driving the CTRL pin is located at a distance to the LT3495, a small 0.1μF capacitor may be needed to bypass the pin locally.

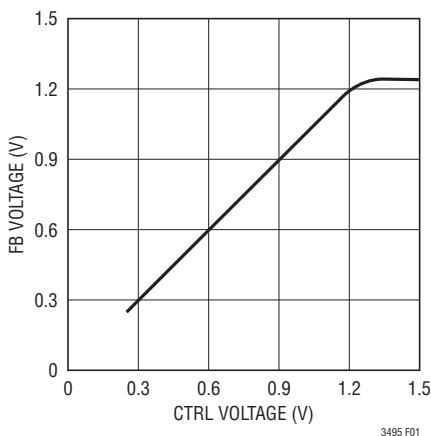

Figure 1. CTRL to FB Transfer Curve

Choosing a Feedback Node

The single feedback resistor may be connected to the V_{OUT} pin or to the CAP pin (see Figure 2). Regulating the V_{OUT} pin eliminates the output offset resulting from the voltage drop across the output disconnect PMOS. Regulating the CAP pin does not compensate for the voltage drop across the output disconnect, resulting in an output voltage V_{OUT} that is slightly lower than the voltage set by the resistor divider. Under most conditions, it is advised that the feedback resistor be tied to the V_{OUT} pin.

Connecting the Load to the CAP Node

The efficiency of the converter can be improved by connecting the load to the CAP pin instead of the V_{OUT} pin. The power loss in the PMOS disconnect circuit is then made negligible. By connecting the feedback resistor to the V_{OUT} pin, no quiescent current will be consumed in the feedback resistor string during shutdown since the PMOS transistor will be open (see Figure 3). The disadvantage of this method is that the CAP node cannot go to ground during shutdown, but will be limited to around a diode drop below V_{CC}. Loads connected to the part should only sink current. Never force external power supplies onto the CAP or V_{OUT} pins.

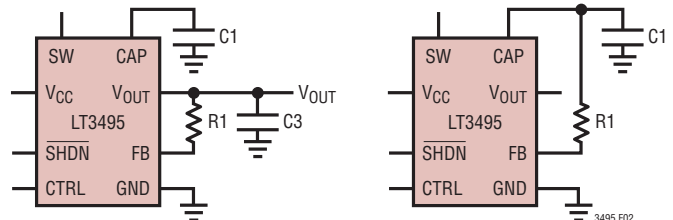

Figure 2. Feedback Connection Using the CAP Pin or the V_{OUT} Pin

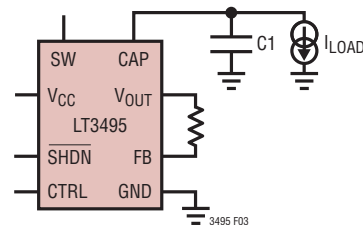

Figure 3. Improved Efficiency Connection

APPLICATIONS INFORMATION

Maximum Output Load Current

The maximum output current of a particular LT3495 series circuit is a function of several circuit variables. The following method can be helpful in predicting the maximum load current for a given circuit:

Step 1: Calculate the peak inductor current:

$$I_{PK} = I_{LIMIT} + \frac{V_{IN} \cdot 200 \cdot 10^{-9}}{L} \text{ amps}$$

where I_{LIMIT} is 0.65A and 0.35A for LT3495/LT3495B and LT3495-1/LT3495B-1 respectively. L is the inductance value in Henrys and V_{IN} is the input voltage to the boost circuit.

Step 2: Calculate the inductor ripple current:

$$I_{RIPPLE} = \frac{(V_{OUT} + 1 - V_{IN}) \cdot 200 \cdot 10^{-9}}{L} \text{ amps}$$

where V_{OUT} is the desired output voltage. If the inductor ripple current is greater than the peak current, then the circuit will only operate in discontinuous conduction mode. The inductor value should be increased so that $I_{RIPPLE} < I_{PK}$. An application circuit can be designed to operate only in discontinuous mode, but the output current capability will be reduced.

Step 3: Calculate the average input current:

$$I_{IN(AVG)} = I_{PK} - \frac{I_{RIPPLE}}{2} \text{ amps}$$

Step 4: Calculate the nominal output current:

$$I_{OUT(NOM)} = \frac{I_{IN(AVG)} \cdot V_{IN} \cdot 0.8}{V_{OUT}} \text{ amps}$$

Step 5: Derate output current:

$$I_{OUT} = I_{OUT(NOM)} \cdot 0.8 \text{ amps}$$

For low output voltages the output current capability will be increased. When using output disconnect (load current taken from V_{OUT}), these higher currents will cause the drop in the PMOS switch to be higher resulting in reduced output current capability than those predicted by the preceding equations.

Inrush Current

When V_{CC} is stepped from ground to the operating voltage while the output capacitor is discharged, a higher level of inrush current may flow through the inductor and Schottky diode into the output capacitor. Conditions that increase inrush current include a larger more abrupt voltage step at V_{IN} , a larger output capacitor tied to the CAP pin and an inductor with a low saturation current. While the chip is designed to handle such events, the inrush current should not be allowed to exceed 1.5A. For circuits that use output capacitor values within the recommended range and have input voltages of less than 5V, inrush current remains low, posing no hazard to the device. In cases where there are large steps at V_{CC} (more than 5V) and/or a large capacitor is used at the CAP pin, inrush current should be measured to ensure safe operation.

Soft-Start

By connecting the \overline{SHDN} and CTRL pins as shown in Figure 4, using an RC filter at the CTRL pin to limit the start-up current, the LT3495 is able to achieve soft-start. The small bias current of the CTRL pin allows using a small capacitor for a large RC time constant. The soft-start waveform is shown in Figure 5. The soft-start time

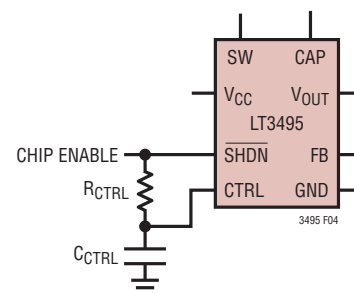

Figure 4. Soft-Start Circuitry

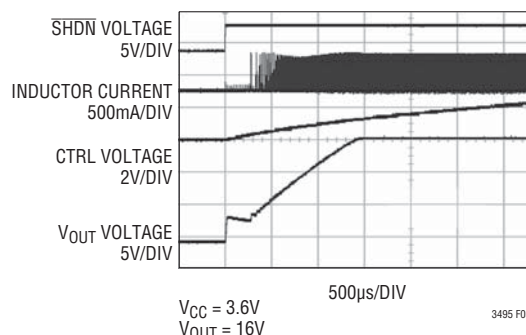

Figure 5. Soft-Start Waveform

APPLICATIONS INFORMATION

can be set by the value of R_{CTRL} and C_{CTRL} . The following expression can be used to design the soft-start time:

$$T_{START-UP} = R_{CTRL} \cdot C_{CTRL} \cdot \ln \left(\frac{V_{SHDN}}{V_{SHDN} - 1.235} \right)$$

where V_{SHDN} is the voltage at \overline{SHDN} pin when the part is enabled. To ensure soft-start will work, the initial voltage at CTRL pin when the part is enabled should be close to 0V. The soft-start may not work if this initial condition is not satisfied.

Output Disconnect

The LT3495 series has an output disconnect PMOS that blocks the load from the input during shutdown. During normal operation, the maximum current through the PMOS is limited by circuitry inside the chip. When the CAP and V_{OUT} voltage difference is more than 8.7V (typ), the current through the PMOS is no longer limited, and can be much higher. As a result, forcing 8.7V or higher voltage from the CAP to the V_{OUT} pins can damage the PMOS. In cases when the CAP voltage is high and/or a large capacitor is used at the CAP pin, shorting V_{OUT} to GND can cause large PMOS currents to flow. Under this condition, the PMOS peak current should be kept at less than 1A.

Also be aware of the thermal dissipation in the PMOS at all times. In addition, if the input voltage is more than 8V, the PMOS will turn on during shutdown, resulting in the output voltage no longer being blocked from the input. Under this condition, the output voltage will be about 8V lower than the input voltage.

Board Layout Considerations

As with all switching regulators, careful attention must be paid to the PCB board layout and component placement. To maximize efficiency, switch rise and fall times are made as short as possible. To prevent electromagnetic interference (EMI) problems, proper layout of the high frequency switching path is essential. The voltage signal of the SW pin has sharp rising and falling edges. Minimize the length and area of all traces connected to the SW pin and always use a ground plane under the switching regulator to minimize interplane coupling. In addition, the FB pin feeds into the internal error amplifier and is sensitive to noise. Minimizing the length and area of all traces to this pin is recommended. Connect the feedback resistor R1 directly from the V_{OUT} pin to the FB pin and keep the trace as short as possible. Recommended component placement is shown in Figure 6.

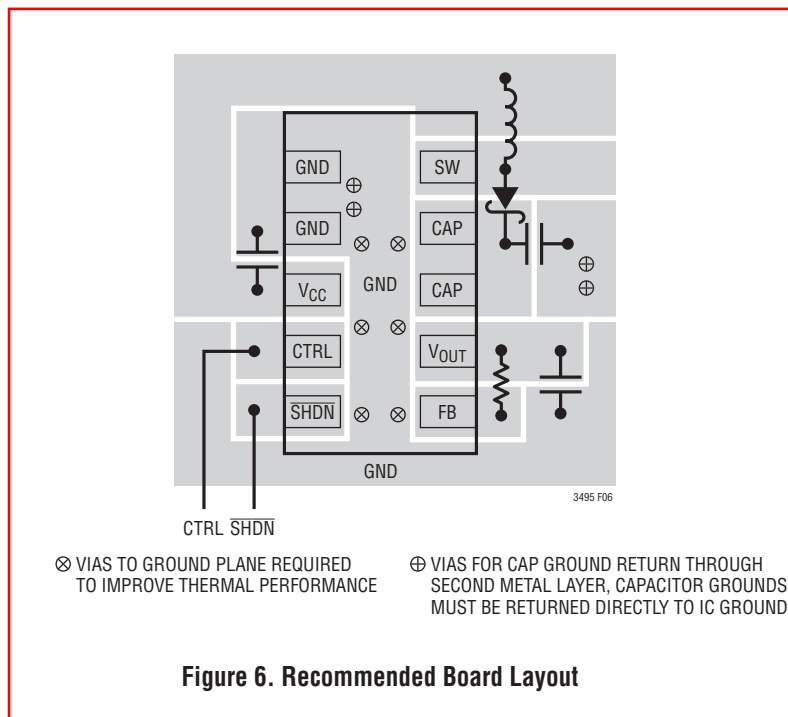

TYPICAL APPLICATIONS

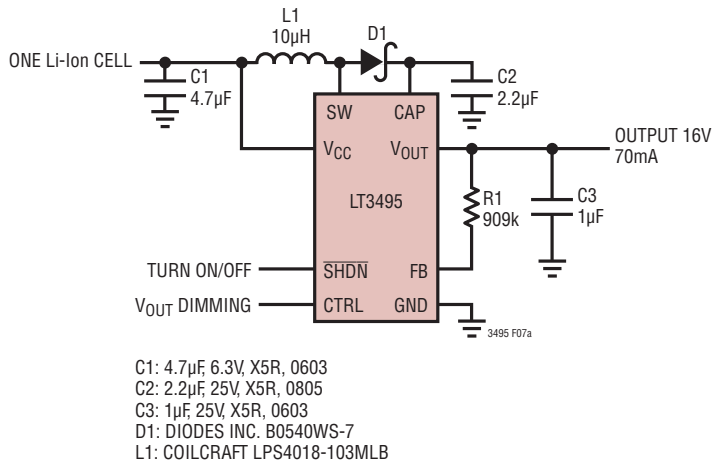

Figure 7. One Li-Ion Cell Input Boost Converter with the LT3495

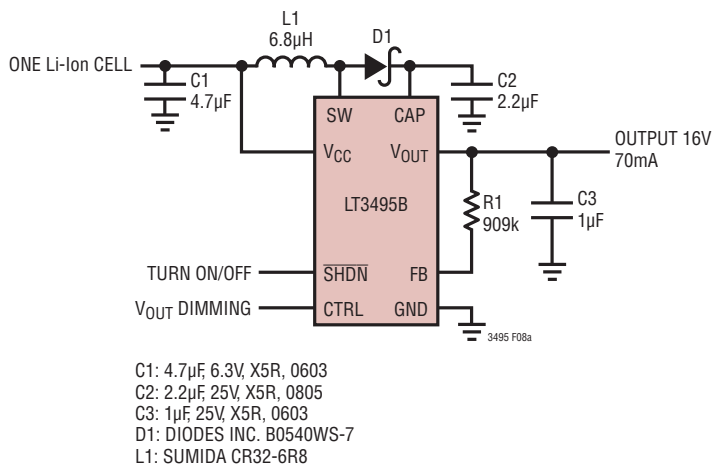
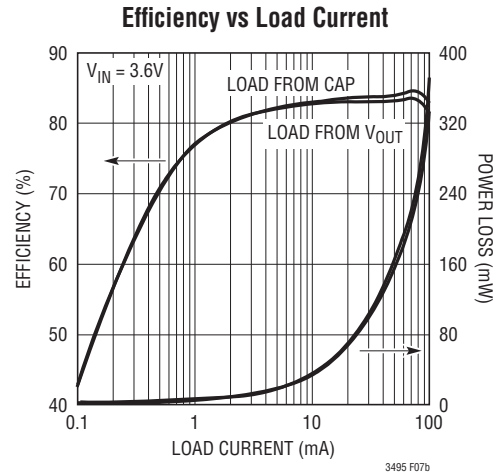
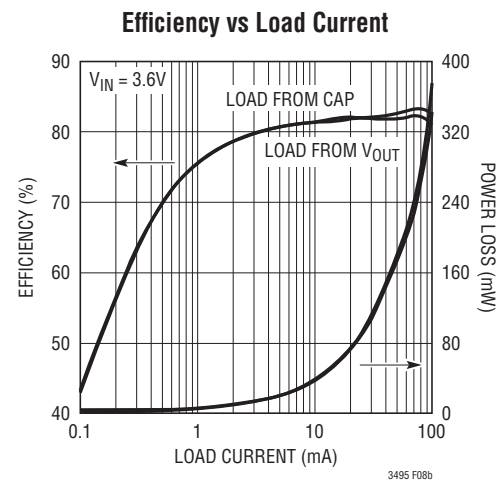

Figure 8. One Li-Ion Cell Input Boost Converter with the LT3495B



LT3495/LT3495B Maximum Output Current vs Output Voltage

V _{OUT}	R1 VALUE REQUIRED (MΩ)	MAXIMUM OUTPUT CURRENT AT 3V INPUT (mA)
40	2.37	26
35	2.05	31
30	1.78	37
25	1.47	43
20	1.15	57
15	0.845	74
10	0.536	120
5	0.232	250

LT3495/LT3495B/ LT3495-1/LT3495B-1

TYPICAL APPLICATIONS

One Li-Ion Cell Input Boost Converter with the LT3495-1/LT3495B-1

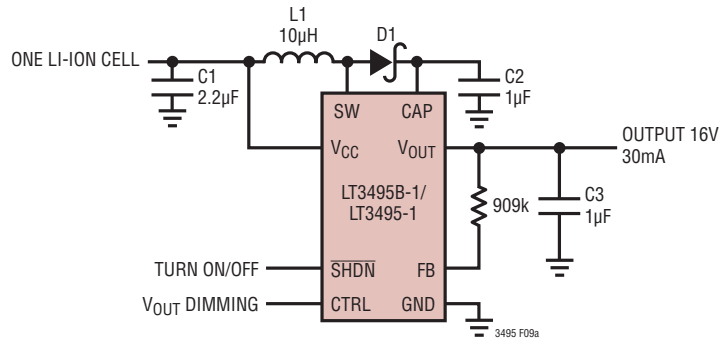

C1: 2.2µF, 6.3V, X5R, 0603
C2: 1µF, 25V, X5R, 0603
C3: 1µF, 25V, X5R, 0603
D1: DIODES INC. B0540WS-7
L1: MURATA LQH32CN100K33

Efficiency vs Load Current

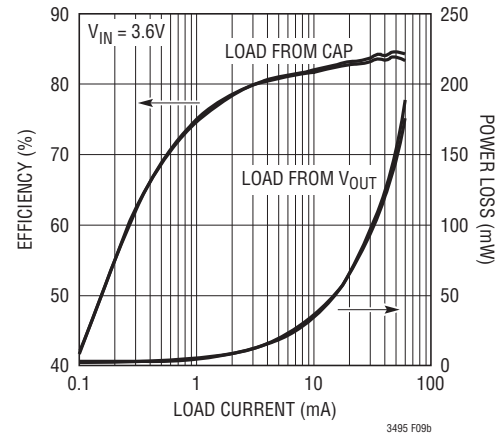

LT3495-1/LT3495B-1 Maximum Output Current vs Output Voltage

V _{OUT}	R1 VALUE REQUIRED (MΩ)	MAXIMUM OUTPUT CURRENT AT 3V INPUT (mA)
40	2.37	12
35	2.05	15
30	1.78	18
25	1.47	21
20	1.15	28
15	0.845	36
10	0.536	63
5	0.232	120

5V to 12V, 130mA Boost Converter

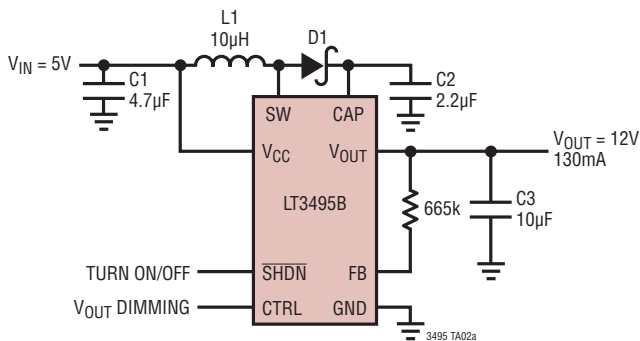

C1: 4.7µF, 6.3V, X5R, 0603
C2: 2.2µF, 25V, X5R, 0805
C3: 10µF, 25V, X5R, 1206
D1: DIODES INC. B0540WS-7
L1: COILCRAFT LPS4018-103MLB

Efficiency vs Load Current

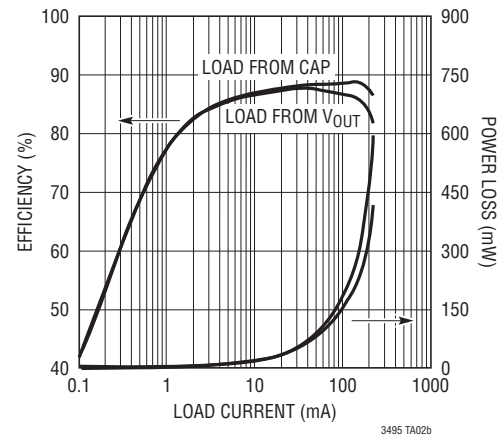

3495b1b1fa

TYPICAL APPLICATIONS

Wide Input Range SEPIC Converter with 5V Output

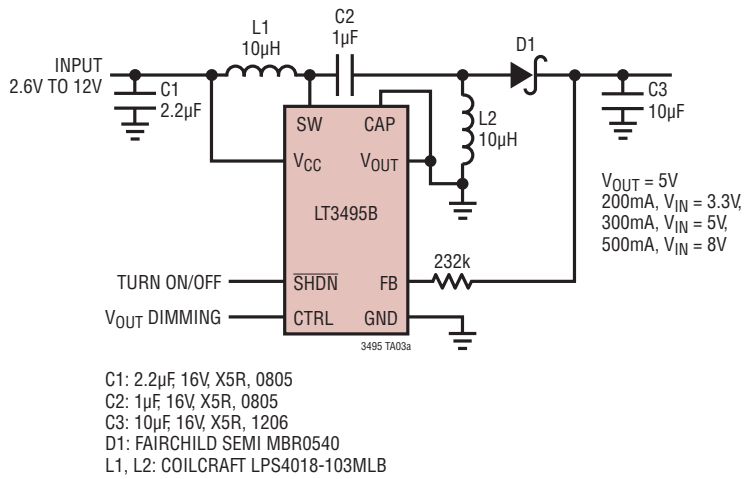

Efficiency vs Load Current

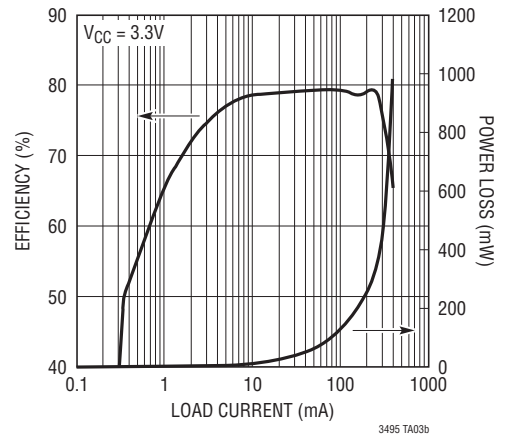

PACKAGE DESCRIPTION

DDB Package 10-Lead Plastic DFN (3mm × 2mm) (Reference LTC DWG # 05-08-1722 Rev 0)

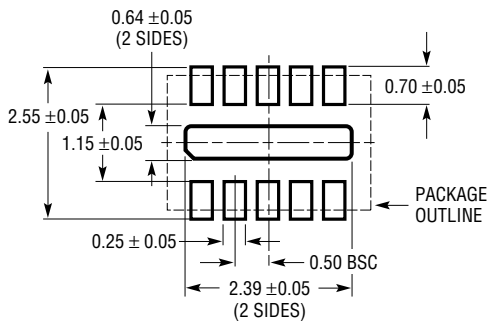

RECOMMENDED SOLDER PAD PITCH AND DIMENSIONS

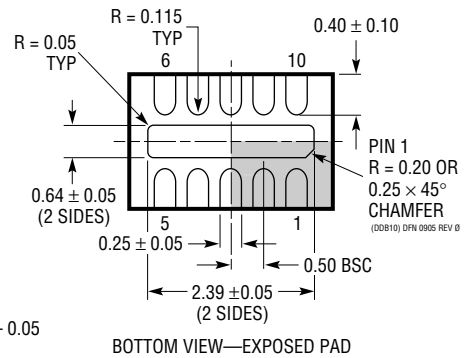
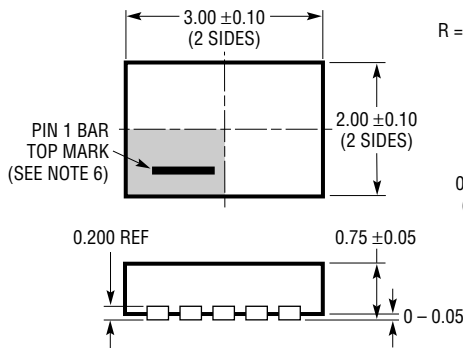

NOTE:

1. DRAWING CONFORMS TO VERSION (WECD-1) IN JEDEC PACKAGE OUTLINE M0-229
2. DRAWING NOT TO SCALE
3. ALL DIMENSIONS ARE IN MILLIMETERS
4. DIMENSIONS OF EXPOSED PAD ON BOTTOM OF PACKAGE DO NOT INCLUDE MOLD FLASH. MOLD FLASH, IF PRESENT, SHALL NOT EXCEED 0.15mm ON ANY SIDE
5. EXPOSED PAD SHALL BE SOLDER PLATED
6. SHADED AREA IS ONLY A REFERENCE FOR PIN 1 LOCATION ON THE TOP AND BOTTOM OF PACKAGE

LT3495/LT3495B/ LT3495-1/LT3495B-1

TYPICAL APPLICATION

Adjustable High Voltage Power Supply Doesn't Need a Transformer

DANGER HIGH VOLTAGE! OPERATION BY HIGH VOLTAGE TRAINED PERSONNEL ONLY

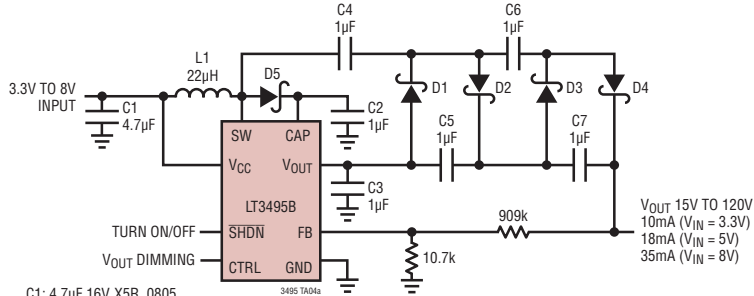

C1: 4.7µF, 16V, X5R, 0805
C2-C7: 1µF, 50V, X5R, 0805
D1-D5: DIODE INC. B0540WS-7
L1: COILCRAFT LPS4018-223MLB

Output vs CTRL

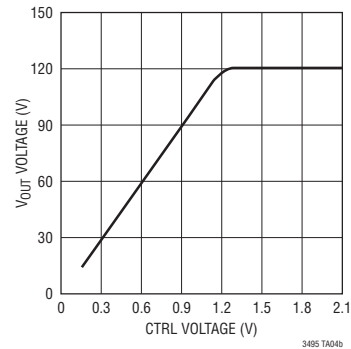

Efficiency vs Load Current

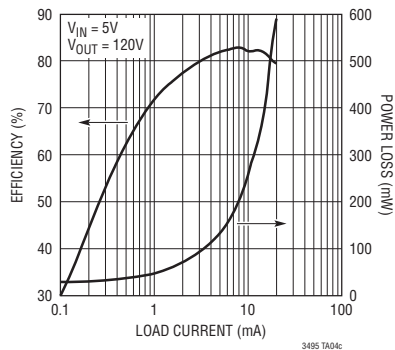

Output Voltage Ripple vs Load Current

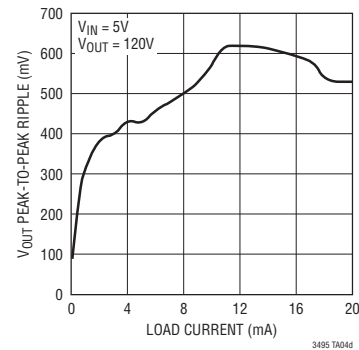

RELATED PARTS

PART NUMBER	DESCRIPTION	COMMENTS
LT1930/LT1930A	1A (I_{SW}), 1.2MHz/2.2MHz, High Efficiency Step-Up DC/DC Converters	V_{IN} : 2.6V to 16V, $V_{OUT(MAX)}$ = 34V, I_Q = 4.2mA/5.5mA, $I_{SD} < 1\mu A$, ThinSOT Package
LT1945 (Dual)	Dual Output, Boost/Inverter, 350mA (I_{SW}), Constant Off-Time, High Efficiency Step-Up DC/DC Converter	V_{IN} : 1.2V to 15V, $V_{OUT(MAX)}$ = $\pm 34V$, I_Q = 40µA, $I_{SD} < 1\mu A$, 10-Lead MS Package
LT1946/LT1946A	1.5A (I_{SW}), 1.2MHz/2.7MHz, High Efficiency Step-Up DC/DC Converters	V_{IN} : 2.45V to 16V, $V_{OUT(MAX)}$ = 34V, I_Q = 3.2mA, $I_{SD} < 1\mu A$, 8-Lead MS Package
LT3463/LT3463A	Dual Output, Boost/Inverter, 250mA (I_{SW}), Constant Off-Time, High Efficiency Step-Up DC/DC Converters with Integrated Schottkys	V_{IN} : 2.3V to 15V, $V_{OUT(MAX)}$ = $\pm 40V$, I_Q = 40µA, $I_{SD} < 1\mu A$, DFN Package
LT3467/LT3467A	1.1A (I_{SW}), 1.3MHz/2.1MHz, High Efficiency Step-Up DC/DC Converters with Soft-Start	V_{IN} : 2.4V to 16V, $V_{OUT(MAX)}$ = 40V, I_Q = 1.2mA, $I_{SD} < 1\mu A$, ThinSOT Package
LT3471	Dual Output, Boost/Inverter, 1.3A (I_{SW}), High Efficiency Boost-Inverting DC/DC Converter	V_{IN} : 2.4V to 16V, $V_{OUT(MAX)}$ = $\pm 40V$, I_Q = 2.5mA, $I_{SD} < 1\mu A$, DFN Package
LT3473/LT3473A	1A (I_{SW}), 1.2MHz, High Efficiency Step-Up DC/DC Converters with Integrated Schottky Diode and Output Disconnect	V_{IN} : 2.2V to 16V, $V_{OUT(MAX)}$ = 36V, I_Q = 100µA, $I_{SD} < 1\mu A$, DFN Package
LT3494/LT3494A	180mA/350mA (I_{SW}), High Efficiency Step-Up DC/DC Converters with Output Disconnect	V_{IN} : 2.1V to 16V, $V_{OUT(MAX)}$ = 40V, I_Q = 65µA, $I_{SD} < 1\mu A$, DFN Package
LT3580	2A, 40V, 2.5MHz Boost DC/DC Converter	V_{IN} : 2.5V to 32V, $V_{OUT(MAX)}$ = 40V, I_Q = 1mA, $I_{SD} < 1\mu A$, MS8E 3mm x 3mm DFN-8 Package

3495b1b1fa