

EHF-1XX-01-XX-D-XX-XX-XX

No OF POSITIONS
 -03, -04, -05, -08, -10, -13, -17, -20, -25

LEAD STYLE
 -01

PLATING SPECIFICATION
-L: LIGHT GOLD (USE T-1SXX-XX-L)
 -F: FLASH SELECTIVE GOLD (USE T-1SXX-XX-F)
 -S: SELECTIVE (USE T-1SXX-XX-S)
 -H: HEAVY GOLD, GOLD FLASH ON TAIL (USE T-1SXX-XX-H)
 -LM: LIGHT SELECTIVE GOLD, MATTE TIN ON TAIL (USE T-1SXX-XX-L)
 -SM: HEAVY SELECTIVE GOLD, MATTE TIN ON TAIL (USE T-1SXX-XX-S)
 -FM: FLASH SELECTIVE GOLD, MATTE TIN ON TAIL (USE T-1SXX-XX-F)

OPTION
 -LC: LOCKING CLIP (FOR -D-SM ONLY)
 -P: PICK & PLACE PAD (FOR -D-SM ONLY) (FOR -03 & -04, USE PPP-25, SEE FIG. 7, SHT 3) (FOR -05 THRU -25, USE PPP-48, SEE FIG. 2)
 -K: POLYIMIDE FILM (USE K-500-300, SEE FIGURE 3)
 -TR: TAPE & REEL PACKAGING (FOR -D-SM, -D-SM-P, & -D-SM-K ONLY) (NOT AVAILABLE ON -D-SM-LC)

POLARIZED OPTION
 -XX = PIN OMITTED (N/A ON -RA OPTION)

TAIL OPTION
 (LEAVE BLANK FOR THROUGH HOLE, SEE FIG. 4, SHEET 2, USE T-1S63-01-XX)
-SM: SURFACE MOUNT (USE T-1S15-02-XX)
 -RA: RIGHT ANGLE (USE T-1S63-02-XX AND T-1S63-03-XX) (SEE FIG. 5, SHEET 2)

ROW SPECIFICATION
-D: DOUBLE

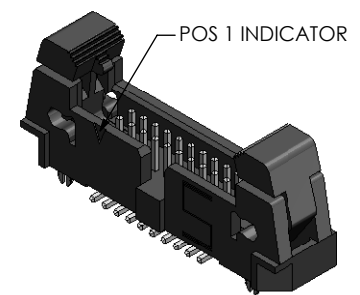
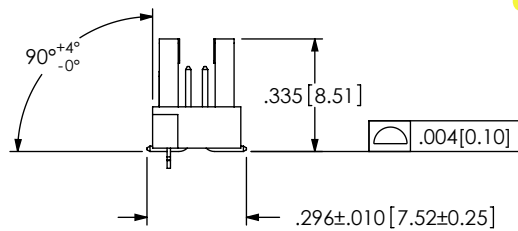

- NOTES:**
1. Ⓢ REPRESENTS A CRITICAL DIMENSION.
 2. COPLANARITY TO BE WITHIN .004 [0.10].
 3. BURR ALLOWANCE: .0015 [0.038] MAX.
 4. MINIMUM PUSHOUT FORCE: 1 LB MIN.
 5. MAXIMUM ALLOWABLE BOW: .002 [0.05] INCH/INCH AFTER ASSEMBLY.
 6. NOTE DELETED.

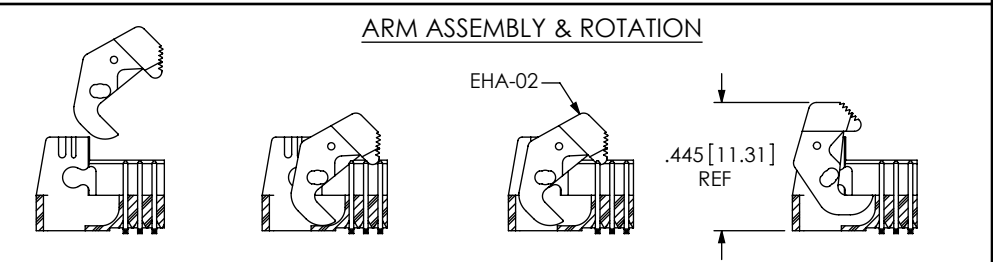
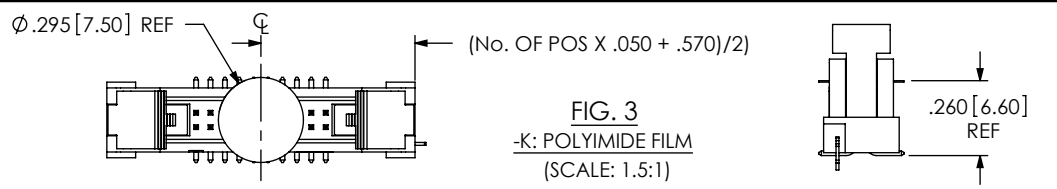
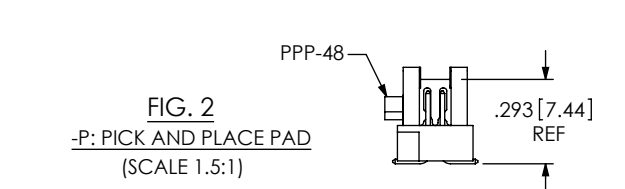
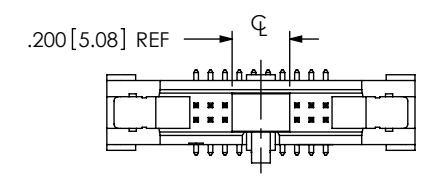
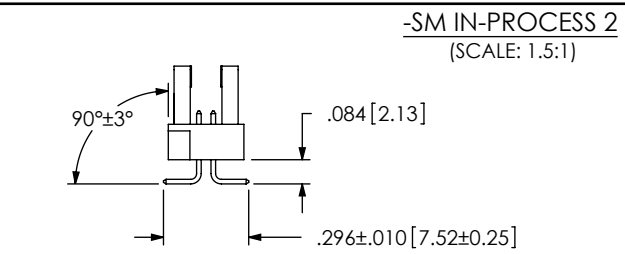
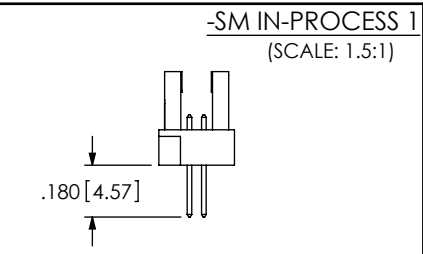

UNLESS OTHERWISE SPECIFIED, DIMENSIONS ARE IN INCHES. TOLERANCES ARE:

DECIMALS	ANGLES
.XX: ±.01 [.3]	2°
.XXX: ±.005 [.13]	
.XXXX: ±.0020 [.051]	

PROPRIETARY NOTE
 THIS DOCUMENT CONTAINS INFORMATION CONFIDENTIAL AND PROPRIETARY TO SAMTEC, INC. AND SHALL NOT BE REPRODUCED OR TRANSFERRED TO OTHER DOCUMENTS OR DISCLOSED TO OTHERS OR USED FOR ANY PURPOSE OTHER THAN THAT WHICH IT WAS OBTAINED WITHOUT THE EXPRESSED WRITTEN CONSENT OF SAMTEC, INC.

samtec
 520 PARK EAST BLVD, NEW ALBANY, IN 47150
 PHONE: 812-944-6733 FAX: 812-948-5047
 e-Mail: info@SAMTEC.com code: 55322

MATERIAL: DO NOT SCALE DRAWING
 INSULATOR: VECTRA E130i, COLOR BLACK 50% REGRIND
 TERMINAL: PHOS BRONZE 510 SPRING

DESCRIPTION: .050 EJECTOR HEADER ASSEMBLY
DWG. NO. EHF-1XX-01-XX-D-XX-XX-XX

FIG. 4

STANDARD THROUGH HOLE
(SHOWN: EHF-110-01-XX-D)
(SAME AS FIG. 1, UNLESS OTHERWISE STATED)

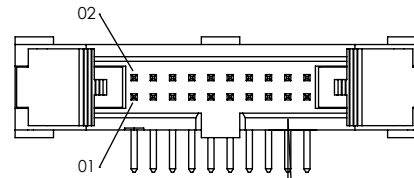
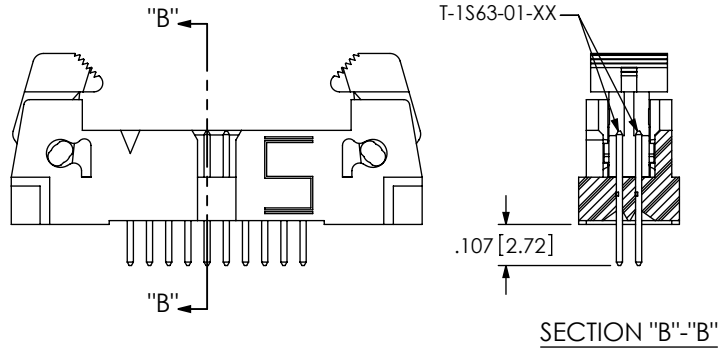
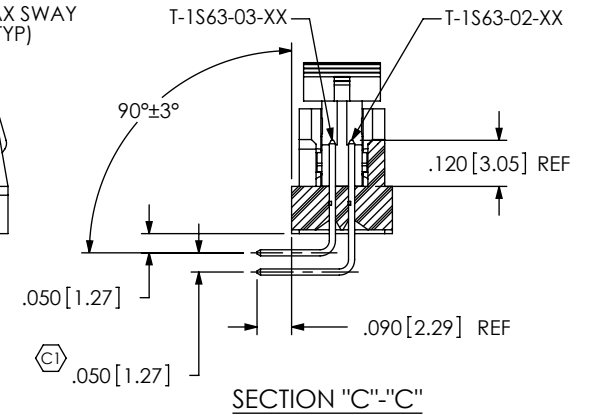

FIG. 5

-RA: RIGHT ANGLE OPTION
(SHOWN: EHF-110-01-XX-D-RA)
(SAME AS FIG. 1, UNLESS OTHERWISE STATED)



PACKAGING VIEWS

(LOAD PARTS WITH POSITION #1 INDICATOR
IN SAME DIRECTION AS ARROW ON TUBE)

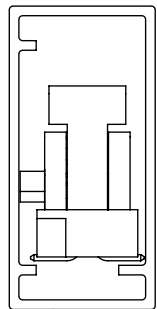

PT-1-24-01-51

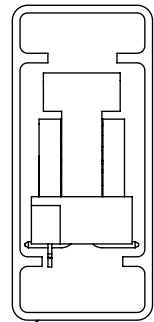

PT-1-24-16-29

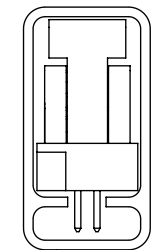

PT-1-24-05-09

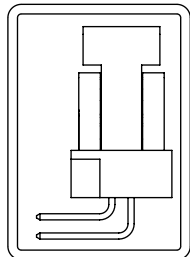

PT-1-24-01-52

-RA IN-PROCESS 1

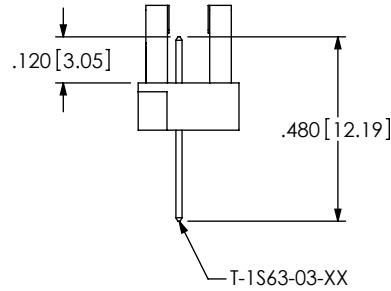

-RA IN-PROCESS 2

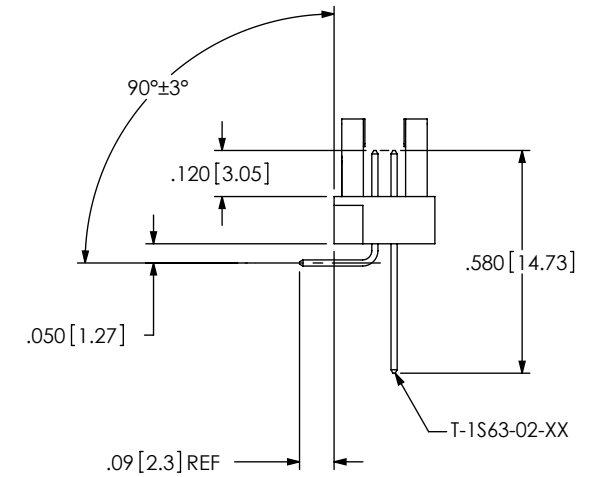

TAIL OPTION	OPTION	PACKAGING TUBE	PLUG
THROUGH HOLE	N/A	PT-1-24-05-09	TP-07
-SM	NONE, -LC, -K, -LC-K	PT-1-24-16-29	
-SM	-P, -LC-P	PT-1-24-01-51	TP-13
-RA	N/A	PT-1-24-01-52	

PROPRIETARY NOTE

THIS DOCUMENT CONTAINS INFORMATION CONFIDENTIAL AND PROPRIETARY TO SAMTEC, INC. AND SHALL NOT BE REPRODUCED OR TRANSFERRED TO OTHER DOCUMENTS OR DISCLOSED TO OTHERS OR USED FOR ANY PURPOSE OTHER THAN THAT WHICH IT WAS OBTAINED WITHOUT THE EXPRESSED WRITTEN CONSENT OF SAMTEC, INC.

DO NOT SCALE DRAWING

SHEET SCALE: 2:1

F:\DWG\MISC\MKTG\EHF-1XX-01-XX-D-XX-XX-XX-MKT.SLDDRW



520 PARK EAST BLVD, NEW ALBANY, IN 47150
PHONE: 812-944-6733 FAX: 812-948-5047
e-Mail: info@SAMTEC.com code: 55322

DESCRIPTION: .050 EJECTOR HEADER ASSEMBLY

DWG. NO. EHF-1XX-01-XX-D-XX-XX-XX

BY: ERIC M. 08/17/01 SHEET 2 OF 3

FIG. 6

-SM: SURFACE MOUNT OPTION
(SHOWN: EHF-110-01-XX-D-SM-LC)
(SHOWN WITH LATCHES OPEN)

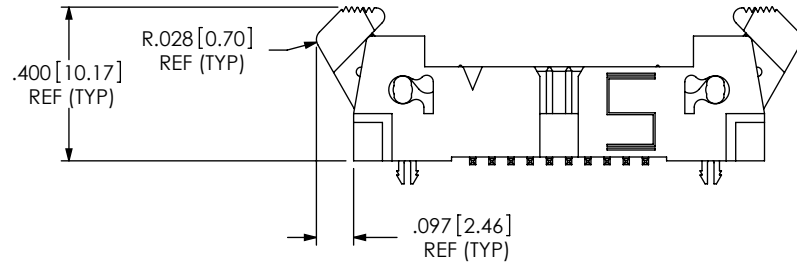
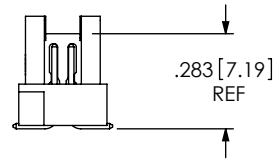
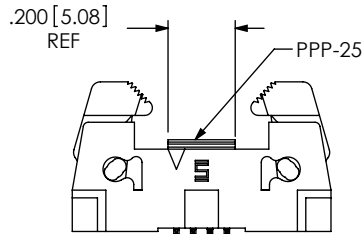

FIG. 7

-03 & -04 PICK AND PLACE PAD
(SHOWN: EHF-104-01-XX-D-SM-XX-P)



LATCHES OMITTED FOR CLARITY

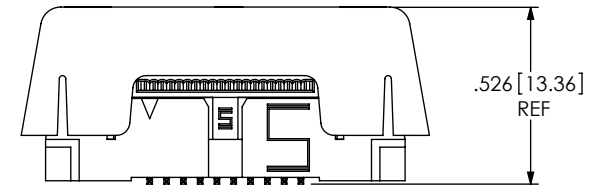
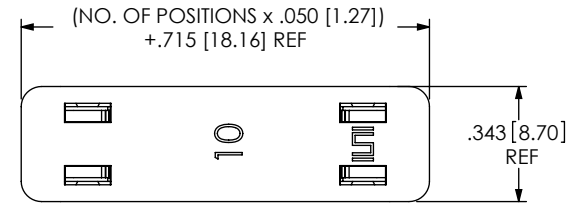

FIG. 8

APPLICATION VIEW
EHF MATED WITH FFSD AND ECF

PROPRIETARY NOTE

THIS DOCUMENT CONTAINS INFORMATION CONFIDENTIAL AND PROPRIETARY TO SAMTEC, INC. AND SHALL NOT BE REPRODUCED OR TRANSFERRED TO OTHER DOCUMENTS OR DISCLOSED TO OTHERS OR USED FOR ANY PURPOSE OTHER THAN THAT WHICH IT WAS OBTAINED WITHOUT THE EXPRESSED WRITTEN CONSENT OF SAMTEC, INC.

DO NOT SCALE DRAWING

SHEET SCALE: 2:1



520 PARK EAST BLVD, NEW ALBANY, IN 47150
PHONE: 812-944-6733 FAX: 812-948-5047
e-Mail: info@SAMTEC.com code: 55322

DESCRIPTION:
.050 EJECTOR HEADER ASSEMBLY

DWG. NO.
EHF-1XX-01-XX-D-XX-XX-XX

BY: ERIC M. 08/17/01 SHEET 3 OF 3

-SM TAIL OPTION

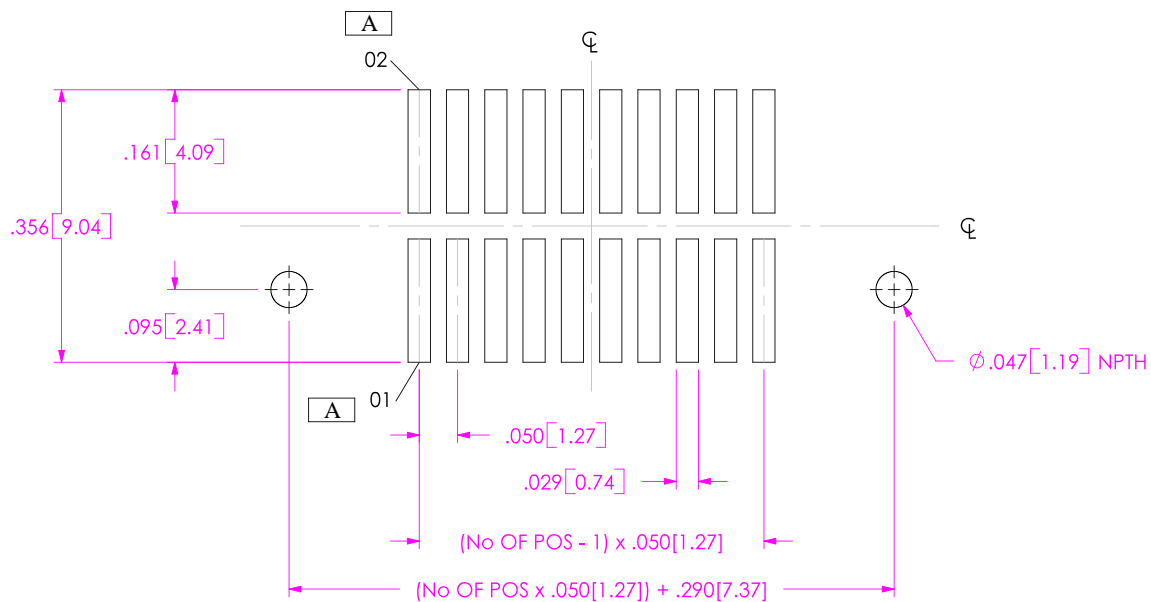

THROUGH HOLE & -RA TAIL OPTION

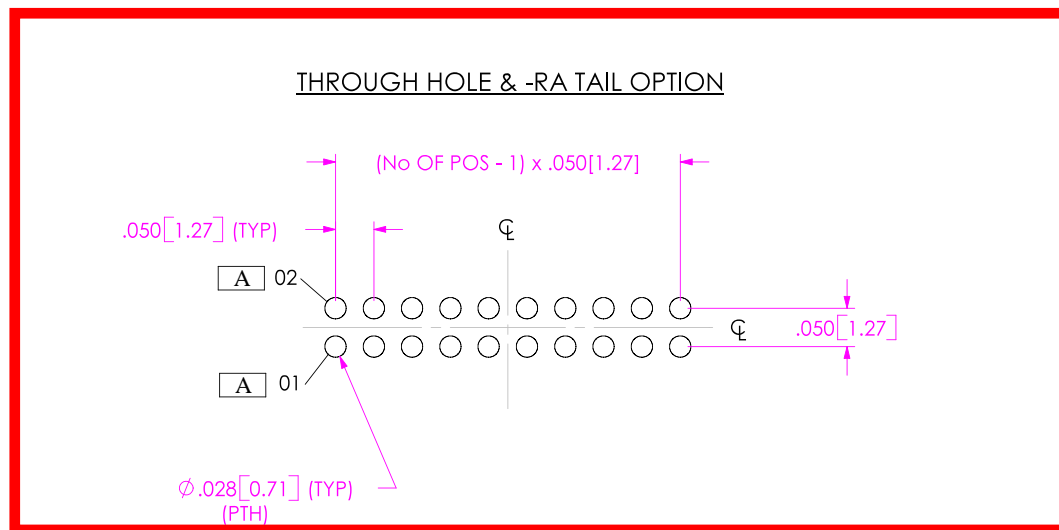

ALL DIMENSIONS ARE SYMMETRIC ABOUT THE CENTERLINE.



PROPRIETARY NOTE
 THIS DOCUMENT CONTAINS INFORMATION CONFIDENTIAL AND PROPRIETARY TO SAMTEC, INC. AND SHALL NOT BE REPRODUCED OR TRANSFERRED TO OTHER DOCUMENTS OR DISCLOSED TO OTHERS OR USED FOR ANY PURPOSE OTHER THAN THAT WHICH IT WAS OBTAINED WITHOUT THE EXPRESSED WRITTEN CONSENT OF SAMTEC, INC.

SAMTEC

520 PARK EAST BLVD, NEW ALBANY, IN 47150
 PHONE: 812.944.6733 FAX: 812.948.5047
 e-Mail: INFO@SAMTEC.COM CODE: 55322

NOTE:
STENCIL TO BE .0060[.152] THICK.

-SM TAIL OPTION

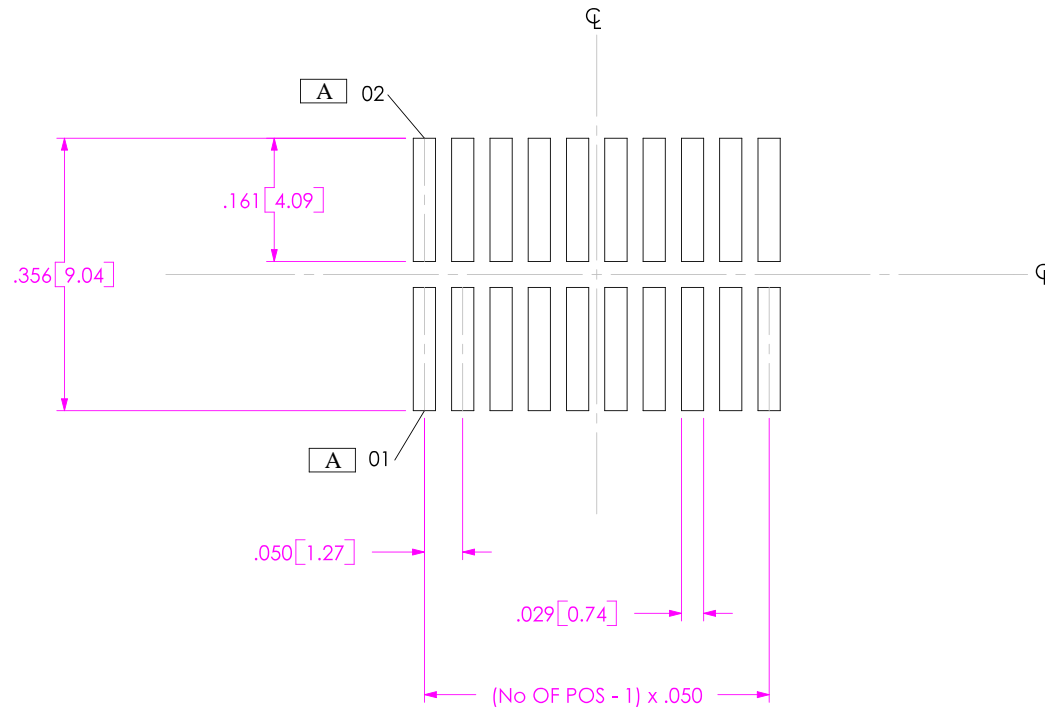

ALL DIMENSIONS ARE SYMMETRIC ABOUT THE CENTERLINE.



PROPRIETARY NOTE
THIS DOCUMENT CONTAINS INFORMATION CONFIDENTIAL AND PROPRIETARY TO SAMTEC, INC. AND SHALL NOT BE REPRODUCED OR TRANSFERRED TO OTHER DOCUMENTS OR DISCLOSED TO OTHERS OR USED FOR ANY PURPOSE OTHER THAN THAT WHICH IT WAS OBTAINED WITHOUT THE EXPRESSED WRITTEN CONSENT OF SAMTEC, INC.

SAMTEC

520 PARK EAST BLVD, NEW ALBANY, IN 47150
PHONE: 812.944.6733 FAX: 812.948.5047
e-Mail: INFO@SAMTEC.COM CODE: 55322