

# 400mA Micropower Synchronous Step-Up DC/DC Converter with Output Disconnect

## FEATURES

- Up to 95% Efficiency
- Output Disconnect and Inrush Current Limit
- Fixed Output Voltages of 3V, 3.3V or 5V
- Delivers 65mA at 3V from a 1V Input
- Delivers 60mA at 3.3V from a 1V Input, or 140mA at 3.3V from a 1.8V Input
- Delivers 175mA at 5V from a 3V Input
- Burst Mode® Operation:  $I_Q = 7\mu A$
- Only Three External Components
- $V_{IN} > V_{OUT}$  Operation
- $<1\mu A$  Shutdown Current
- Antiringing Control
- Short-Circuit and Overtemperature Protection
- Very Low Profile of 1mm
- Tiny 6-Pin SC70 Package

## APPLICATIONS

- MP3 Players
- Portable Instruments
- Glucose Meters
- Digital Cameras

## DESCRIPTION

The LTC®3525-3/LTC3525-3.3/LTC3525-5 are high efficiency synchronous step-up DC/DC converters with output disconnect that can start up with an input as low as 1V. They offer a compact, high efficiency alternative to charge pumps in single cell or dual cell alkaline or Li-ion applications. Only three small external components are required. The LTC3525 is offered in fixed output voltages of 3V, 3.3V or 5V.

The device includes a  $0.5\Omega$  N-channel MOSFET switch and a  $0.8\Omega$  P-channel synchronous rectifier. Peak switch current ranges from 150mA to 400mA, depending on load, providing enhanced efficiency. Quiescent current is an ultralow  $7\mu A$ , maximizing battery life in portable applications.

Other features include  $<1\mu A$  shutdown current, anti-ringing control and thermal shutdown. The LTC3525 is available in a tiny 6-pin SC70 package.

LT, LTC and LT are registered trademarks of Linear Technology Corporation. Burst Mode is a registered trademark of Linear Technology Corporation. All other trademarks are the property of their respective owners. Patents Pending

## TYPICAL APPLICATION

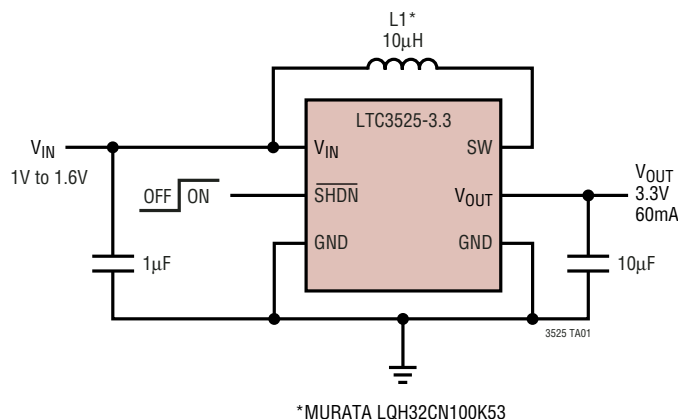

**LTC3525-3.3 Efficiency and Power Loss vs Load Current**

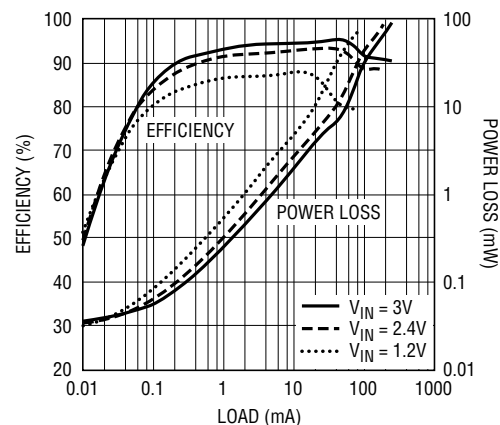

LT3525 • TA02

3525fa

# LTC3525-3/ LTC3525-3.3/LTC3525-5

## ABSOLUTE MAXIMUM RATINGS

(Note 1)

$V_{IN}$ , $V_{OUT}$ Voltage .....	-0.3V to 6V
SW Voltage .....	-0.3V to 6V
SW Voltage < 100ns .....	-0.3V to 7V
SHDN Voltage .....	-0.3V to 6V
Operating Temperature Range (Notes 2, 5).....	-40°C to 85°C
Storage Temperature Range.....	-65°C to 125°C
Lead Temperature (Soldering, 10 sec) .....	300°C

## PACKAGE/ORDER INFORMATION

ORDER PART NUMBER	SC6 PART MARKING
LTC3525ESC6-3 LTC3525ESC6-3.3 LTC3525ESC6-5	LCDR LBTG LBWT
<b>Order Options</b> Tape and Reel: Add #TR Lead Free: Add #PBF Lead Free Tape and Reel: Add #TRPBF Lead Free Part Marking: <a href="http://www.linear.com/leadfree/">http://www.linear.com/leadfree/</a>	

Consult LTC Marketing for parts specified with wider operating temperature ranges.

## ELECTRICAL CHARACTERISTICS (LTC3525-3)

The ● denotes the specifications which apply over the full operating temperature range, otherwise specifications are at  $T_A = 25^\circ\text{C}$ .  
 $V_{IN} = 1.2\text{V}$ ,  $V_{SHDN} = 1.2\text{V}$ ,  $V_{OUT} = 3\text{V}$  unless otherwise noted.

PARAMETER	CONDITIONS	MIN	TYP	MAX	UNITS
Input Start-Up Voltage			0.85	1	V
Output Voltage	(Note 6) ●	2.91	3.00	3.09	V
Quiescent Current, $V_{OUT}$	$\overline{\text{SHDN}} = V_{IN}$ (Note 4)		7	15	$\mu\text{A}$
Quiescent Current, $V_{IN}$	$\overline{\text{SHDN}} = V_{IN}$ (Note 4)		0.5	3	$\mu\text{A}$
Quiescent Current, $V_{IN}$ - Shutdown	$\overline{\text{SHDN}} = 0\text{V}$ , $V_{OUT} = 0\text{V}$ Not Including Switch Leakage		0.1	1	$\mu\text{A}$
NMOS Switch Leakage	$V_{IN} = V_{OUT} = V_{SW} = 5\text{V}$ , $\overline{\text{SHDN}} = 0\text{V}$		0.1	1	$\mu\text{A}$
PMOS Switch Leakage	$V_{IN} = V_{SW} = 5\text{V}$ , $V_{OUT} = 0\text{V}$ , $\overline{\text{SHDN}} = 0\text{V}$		0.1	3	$\mu\text{A}$
NMOS Switch On Resistance	(Note 3)		0.6		$\Omega$
PMOS Switch On Resistance	(Note 3)		0.9		$\Omega$
Peak Current Limit		0.4	0.45		A
SHDN Threshold		0.4	0.6	1	V
SHDN Input Current	$V_{SHDN} = V_{IN}$ or $V_{OUT}$		0.01	1	$\mu\text{A}$

3525fa

## ELECTRICAL CHARACTERISTICS (LTC3525-3.3)

The ● denotes the specifications which apply over the full operating temperature range, otherwise specifications are at  $T_A = 25^\circ\text{C}$ .  $V_{IN} = 1.2\text{V}$ ,  $V_{SHDN} = 1.2\text{V}$ ,  $V_{OUT} = 3.3\text{V}$  unless otherwise noted.

PARAMETER	CONDITIONS	MIN	TYP	MAX	UNITS
Input Start-Up Voltage			0.85	1	V
Output Voltage	(Note 6)	● 3.20	3.30	3.40	V
Quiescent Current, $V_{OUT}$	$\overline{\text{SHDN}} = V_{IN}$ (Note 4)		7	15	$\mu\text{A}$
Quiescent Current, $V_{IN}$	$\overline{\text{SHDN}} = V_{IN}$ (Note 4)		0.5	3	$\mu\text{A}$
Quiescent Current, $V_{IN}$ - Shutdown	$\overline{\text{SHDN}} = 0\text{V}$ , $V_{OUT} = 0\text{V}$ Not Including Switch Leakage		0.1	1	$\mu\text{A}$
NMOS Switch Leakage	$V_{IN} = V_{OUT} = V_{SW} = 5\text{V}$ , $\overline{\text{SHDN}} = 0\text{V}$		0.1	1	$\mu\text{A}$
PMOS Switch Leakage	$V_{IN} = V_{SW} = 5\text{V}$ , $V_{OUT} = 0\text{V}$ , $\overline{\text{SHDN}} = 0\text{V}$		0.1	3	$\mu\text{A}$
NMOS Switch On Resistance	(Note 3)		0.5		$\Omega$
PMOS Switch On Resistance	(Note 3)		0.8		$\Omega$
Peak Current Limit		0.4	0.45		A
$\overline{\text{SHDN}}$ Threshold		0.4	0.6	1	V
$\overline{\text{SHDN}}$ Input Current	$V_{\overline{\text{SHDN}}} = V_{IN}$ or $V_{OUT}$		0.01	1	$\mu\text{A}$

## (LTC3525-5)

The ● denotes the specifications which apply over the full operating temperature range, otherwise specifications are at  $T_A = 25^\circ\text{C}$ .  $V_{IN} = 2.4\text{V}$ ,  $V_{SHDN} = 2.4\text{V}$ ,  $V_{OUT} = 5\text{V}$  unless otherwise noted.

PARAMETER	CONDITIONS	MIN	TYP	MAX	UNITS
Input Start-Up Voltage			0.85	1	V
Output Voltage	(Note 6)	● 4.85	5.00	5.15	V
Quiescent Current, $V_{OUT}$	$\overline{\text{SHDN}} = V_{IN}$ (Note 4)		8	18	$\mu\text{A}$
Quiescent Current, $V_{IN}$	$\overline{\text{SHDN}} = V_{IN}$ (Note 4)		1.5	5	$\mu\text{A}$
Quiescent Current, $V_{IN}$ - Shutdown	$\overline{\text{SHDN}} = 0\text{V}$ , $V_{OUT} = 0\text{V}$ Not Including Switch Leakage		0.1	1	$\mu\text{A}$
NMOS Switch Leakage	$V_{IN} = V_{OUT} = V_{SW} = 5\text{V}$ , $\overline{\text{SHDN}} = 0\text{V}$		0.1	1	$\mu\text{A}$
PMOS Switch Leakage	$V_{IN} = V_{SW} = 5\text{V}$ , $V_{OUT} = 0\text{V}$ , $\overline{\text{SHDN}} = 0\text{V}$		0.1	3	$\mu\text{A}$
NMOS Switch On Resistance	(Note 3)		0.4		$\Omega$
PMOS Switch On Resistance	(Note 3)		0.7		$\Omega$
Peak Current Limit		0.4	0.5		A
$\overline{\text{SHDN}}$ Threshold		0.4	0.6	1	V
$\overline{\text{SHDN}}$ Input Current	$V_{\overline{\text{SHDN}}} = V_{IN}$ or $V_{OUT}$		0.01	1	$\mu\text{A}$

**Note 1:** Stresses beyond those listed under Absolute Maximum Ratings may cause permanent damage to the device. Exposure to any Absolute Maximum Rating condition for extended periods may affect device reliability and lifetime.

**Note 2:** The LTC3525E is guaranteed to meet performance specifications from  $0^\circ\text{C}$  to  $85^\circ\text{C}$ . Specifications over the  $-40^\circ\text{C}$  to  $85^\circ\text{C}$  operating temperature range are assured by design, characterization and correlation with statistical process controls.

**Note 3:** Specification is guaranteed by design and not 100% tested in production.

**Note 4:** Current Measurements are performed when the LTC3525 is not switching.

**Note 5:** This IC includes overtemperature protection that is intended to protect the device during momentary overload conditions. Junction temperature will exceed  $125^\circ\text{C}$  when overtemperature protection is active. Continuous operation above the specified maximum operating junction temperature may impair device reliability.

**Note 6:** Consult LTC Marketing for other output voltage options.

# LTC3525-3/ LTC3525-3.3/LTC3525-5

## TYPICAL PERFORMANCE CHARACTERISTICS $T_A = 25^\circ\text{C}$ unless otherwise noted.

**Maximum Output Current vs  $V_{IN}$**   
(for  $V_{OUT}$  to Drop 2.5%)

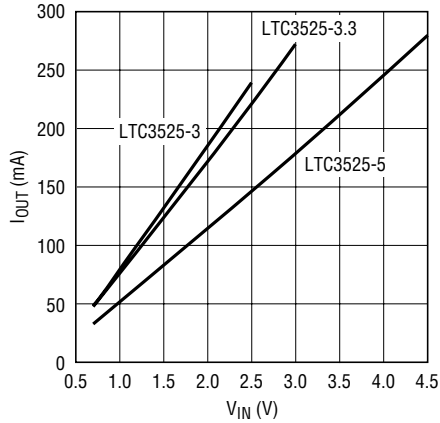

3525 G01

**Maximum Startup Load vs  $V_{IN}$**   
(Resistive Load)

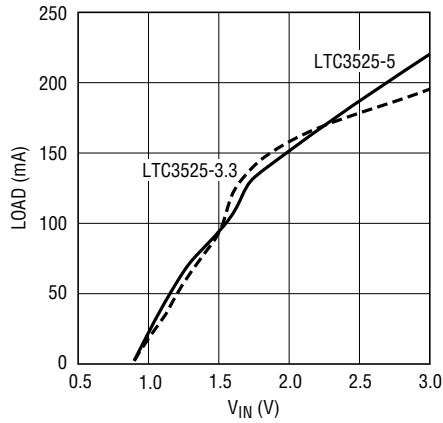

3525 G02

**No-Load Input Current vs  $V_{IN}$**

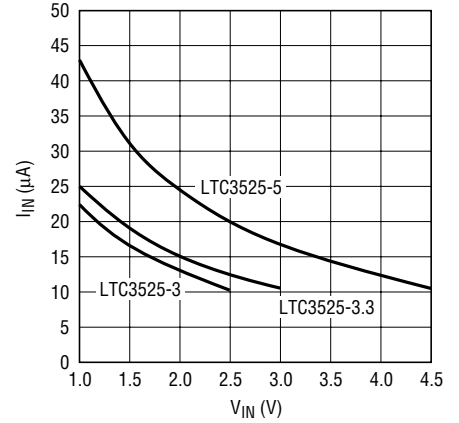

3525 G03

**LTC3525-3 Efficiency and Power Loss vs Load**

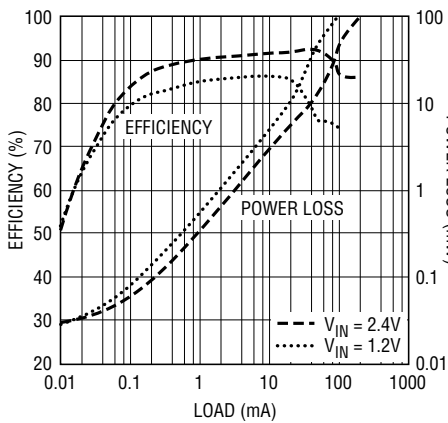

3525 G24

**LTC3525-3.3 Efficiency and Power Loss vs Load**

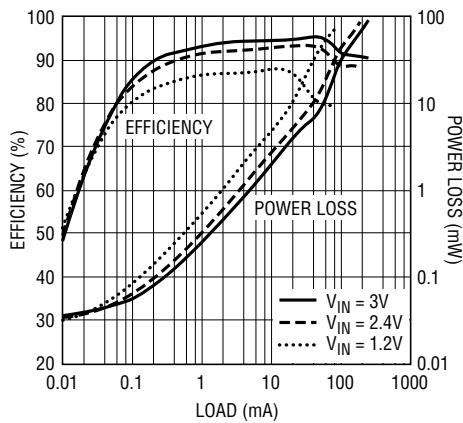

3525 G04

**LTC3525-5 Efficiency and Power Loss vs Load**

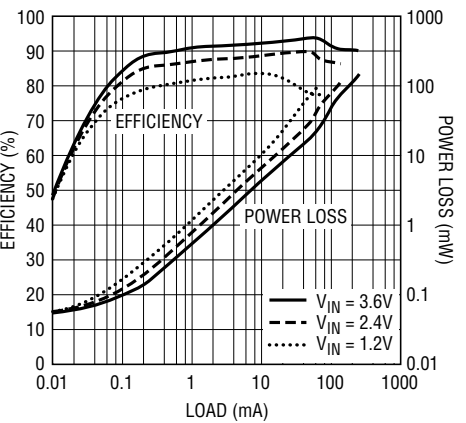

3525 G05

**LTC3525-3.3 Load Regulation**

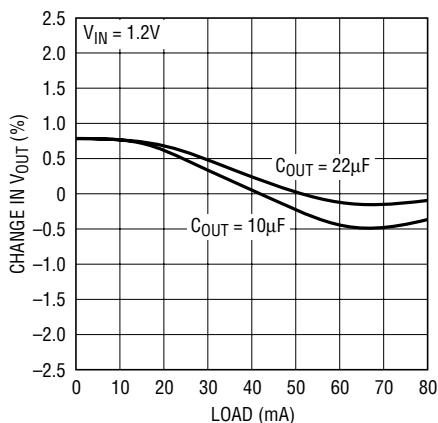

3525 G06

**LTC3525-3.3 Load Regulation**

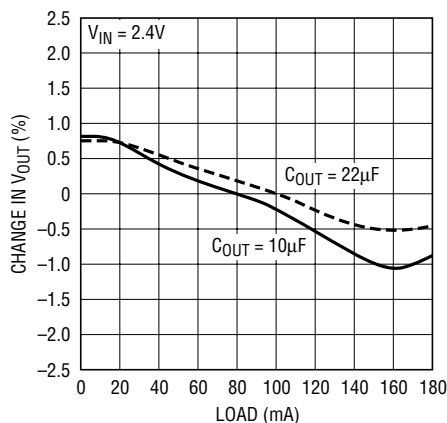

3525 G07

**LTC3525-5 Load Regulation**

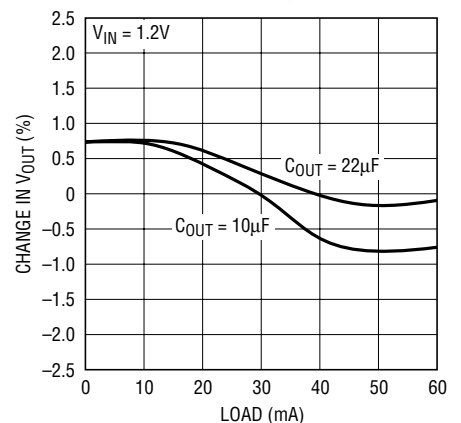

3525 G08

3525fa

**TYPICAL PERFORMANCE CHARACTERISTICS**  $T_A = 25^\circ\text{C}$  unless otherwise noted.

**LTC3525-5 Load Regulation**

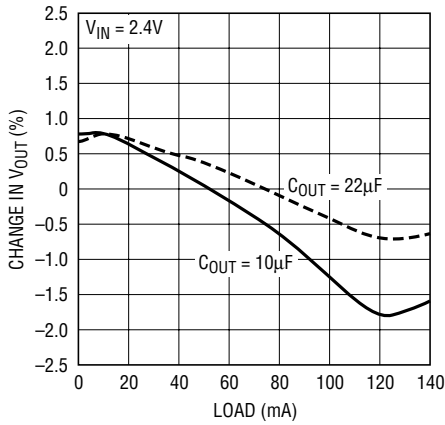

3525 G09

**LTC3525-5 Load Regulation**

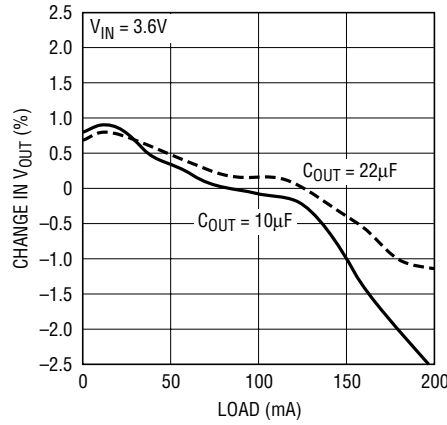

3525 G10

**Switching Frequency vs  $V_{IN}$**

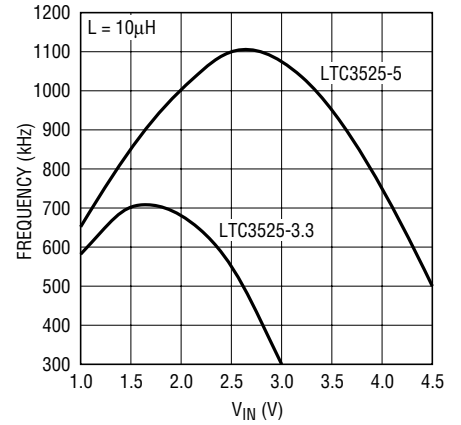

3525 G11

**Light Load Burst Frequency vs Load**

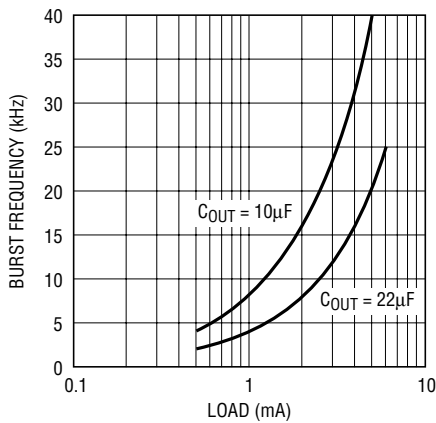

3525 G12

**$V_{OUT}$  Variation vs Temperature (Normalized to  $25^\circ\text{C}$ )**

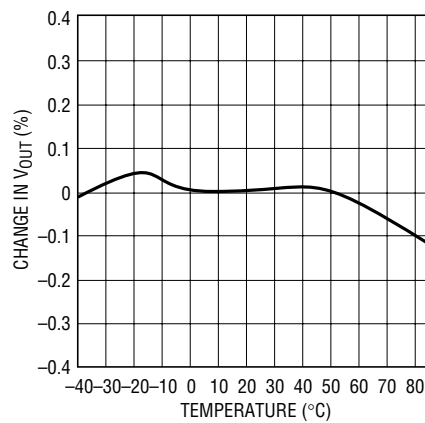

3525 G13

**Startup Delay Coming Out of Shutdown**

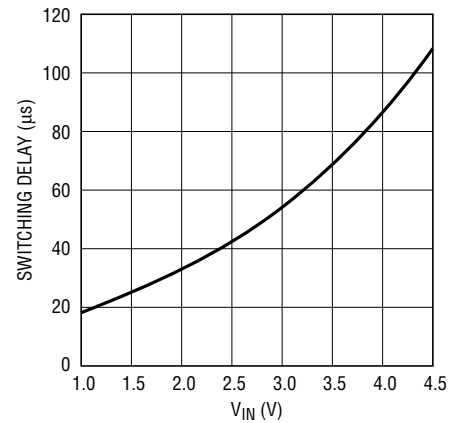

3525 G14

**LTC3525-3.3 Input Current and  $V_{OUT}$  at Startup**

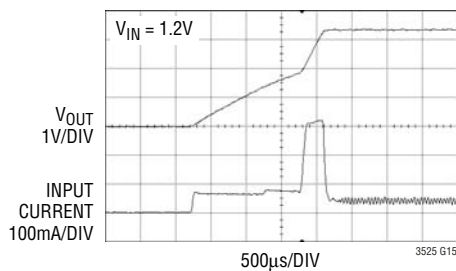

3525 G15

**LTC3525-3.3 Output Voltage Ripple**

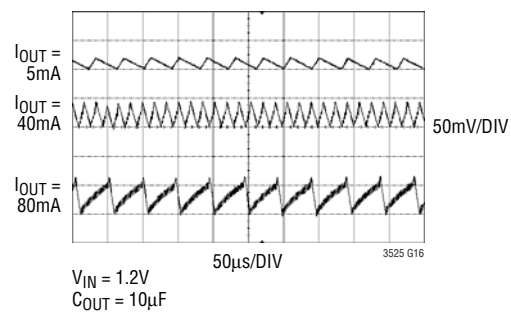

3525 G16

# LTC3525-3/ LTC3525-3.3/LTC3525-5

## TYPICAL PERFORMANCE CHARACTERISTICS $T_A = 25^\circ\text{C}$ unless otherwise noted.

**LTC3525-3.3 Output Voltage Ripple**

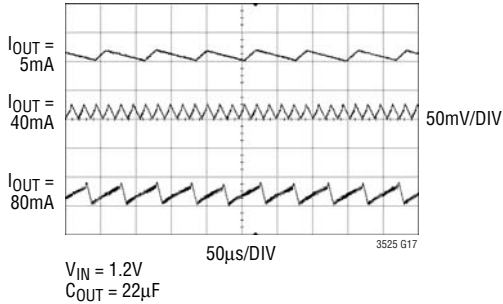

**LTC3525-3.3 Output Voltage Ripple**

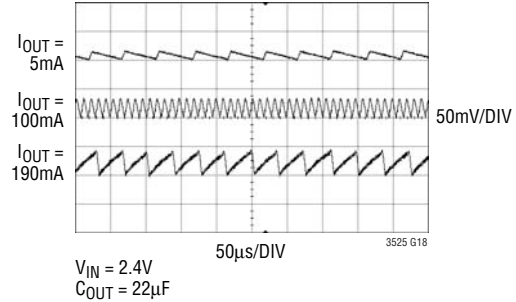

**LTC3525-5 Output Voltage Ripple**

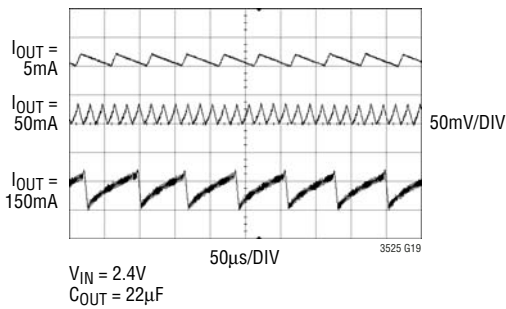

**LTC3525-5 Output Voltage Ripple**

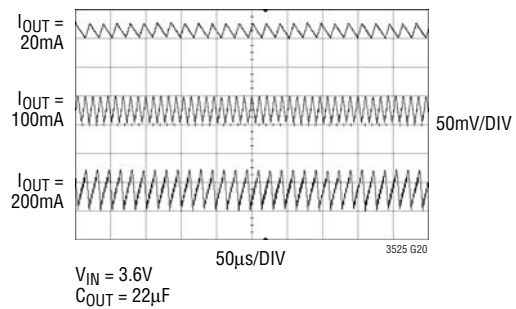

**LTC3525-3.3 50mA Load Step Response**

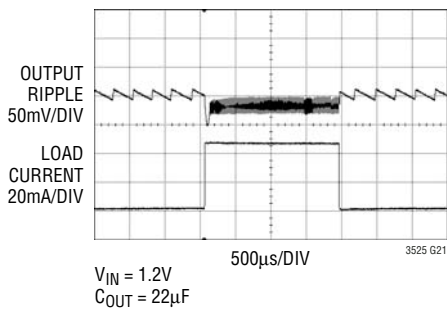

**LTC3525-3.3 100mA Load Step Response**

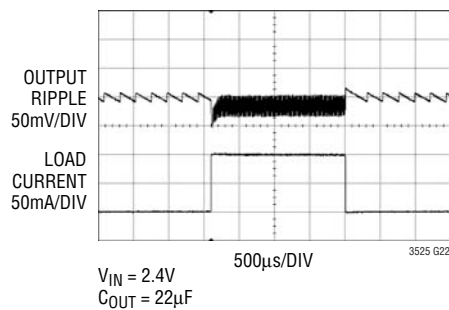

**LTC3525-5 100mA Load Step Response**

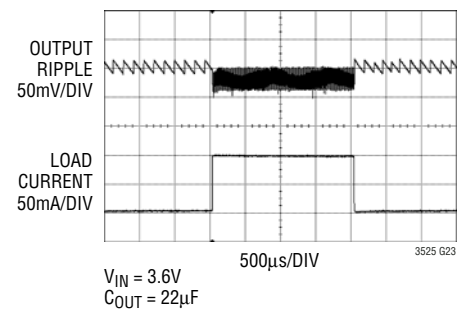

## PIN FUNCTIONS

**SHDN (Pin 1):** Logic Controlled Shutdown Input. Connect to a voltage  $>1V$  to enable the LTC3525. Connect to a voltage  $<0.4V$  to disable the LTC3525.

**GND (Pins 2, 5):** Ground.

**V<sub>IN</sub> (Pin 3):** Input Voltage. The LTC3525 is powered from V<sub>IN</sub> until V<sub>OUT</sub> exceeds V<sub>IN</sub>. Once V<sub>OUT</sub> is greater than (V<sub>IN</sub> + 0.2V typical), it is powered from V<sub>OUT</sub>. Place a ceramic bypass capacitor from V<sub>IN</sub> to GND. A minimum value of 1 $\mu$ F is recommended.

**V<sub>OUT</sub> (Pin 4):** Output Voltage Sense and the Output of the Synchronous Rectifier. Connect the output filter capacitor from V<sub>OUT</sub> to GND, close to the IC. A minimum value of 10 $\mu$ F ceramic is recommended. Use 22 $\mu$ F for reduced output ripple. The output disconnect feature disconnects V<sub>OUT</sub> from V<sub>IN</sub> when SHDN is  $<0.4V$ .

**SW (Pin 6):** Switch Pin. Connect an inductor from this pin to V<sub>IN</sub>. An internal antiringing resistor is connected across SW and V<sub>IN</sub> after the inductor current has dropped to zero to minimize EMI.

## BLOCK DIAGRAM

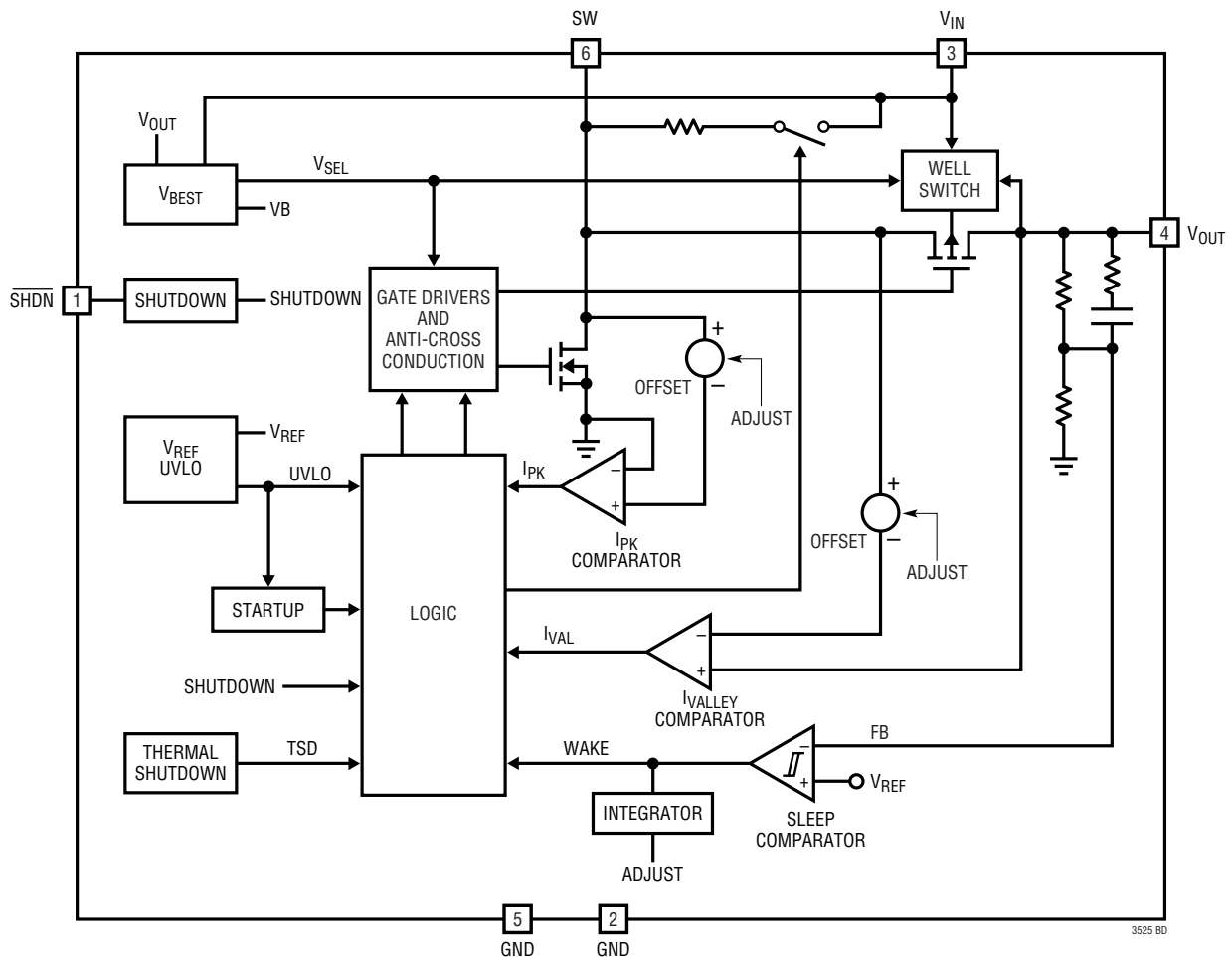

## OPERATION

The LTC3525 is a high performance Burst Mode operation only, synchronous boost converter requiring only three small external components. Its simplicity and small size make it a high efficiency alternative to charge pump designs. It is designed to start up from a single alkaline or nickel cell, with input voltages as low as 1V, or from two or three cells (or a Li-ion battery), with voltages as high as 4.5V. Once started,  $V_{IN}$  can be as low as 0.5V (depending on load current) and maintain regulation. The output voltage is preset internally to either 3V, 3.3V or 5V. Peak switch current is 400mA minimum, providing regulation with load currents up to 150mA, depending on input voltage.

Synchronous rectification provides high efficiency operation while eliminating the need for an external Schottky diode. True output disconnect eliminates inrush current at start-up, and allows  $V_{OUT}$  to be disconnected from  $V_{IN}$ , for zero shutdown current.

The output disconnect feature also allows the LTC3525 to maintain regulation with an input voltage equal to or greater than  $V_{OUT}$ . Note, however, that the synchronous rectifier is not enabled in this mode resulting in lower efficiency and reduced output current capability.

The operating quiescent current is only 7 $\mu$ A typical, allowing the converter to maintain high efficiency at extremely light loads.

### Shutdown

The LTC3525 is shut down by pulling  $\overline{SHDN}$  below 0.4V, and made active by raising it above 1V. Note that  $\overline{SHDN}$  can be driven as high as 6V, however, if it is more than 0.9V above the higher of  $V_{IN}$  or  $V_{OUT}$ , the  $\overline{SHDN}$  input current will increase from zero to 1.5 $\mu$ A.

After the  $\overline{SHDN}$  pin rises, there is a short delay before switching starts. The delay is 20 $\mu$ s to 120 $\mu$ s, depending on input voltage (see Typical Performance Characteristics curve).

### Start-up

A start-up oscillator allows the LTC3525 to start with input voltages as low as 1V. It remains in start-up mode until two conditions are met.  $V_{OUT}$  must exceed  $V_{IN}$  by at least 0.2V typical and either  $V_{IN}$  or  $V_{OUT}$  must be greater than 1.8V typical.

During startup, the synchronous rectifier is not enabled, and the internal P-channel synchronous rectifier acts as a follower, causing the peak voltage on SW to reach ( $V_{IN} + 1V$ ) typical. This limits inrush current by maintaining control of the inductor current when  $V_{OUT}$  is less than  $V_{IN}$ . To reduce power dissipation in the P-channel synchronous rectifier when the output is shorted, a foldback feature is incorporated that reduces the peak inductor current when  $V_{IN}$  is more than 1.7V greater than  $V_{OUT}$ .

### Normal Operation

Once  $V_{OUT}$  has increased more than 0.2V typical above  $V_{IN}$ , and either voltage is above 1.8V, normal operation begins, with synchronous rectification enabled. In this mode, the internal N-channel MOSFET connected between SW and GND stays on until the inductor current reaches a maximum peak value, after which it is turned off and the P-channel synchronous rectifier is turned on. It stays on, delivering current to the output, until the inductor current has dropped below a minimum value at which point it turns off and the cycle repeats. When the output voltage reaches its regulated value both switches are turned off and the LTC3525 goes to sleep, during which time the output capacitor supplies current to the load. Once the output voltage drops approximately 9mV below the regulation value the IC leaves sleep mode and switching is resumed.

The LTC3525 has been designed for low output voltage ripple. The output voltage ripple is typically only 20mV peak-to-peak at light load and 60mV peak-to-peak at



## OPERATION

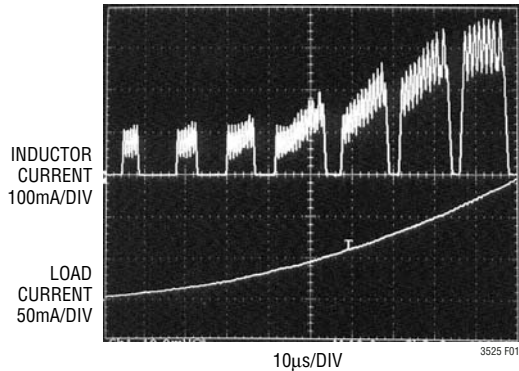

Figure 1. Inductor Current Changing as a Function of Load

full load using the minimum recommended 10µF output capacitor for the LTC3525-3.3 and a 22µF capacitor for the LTC3525-5 (due to the capacitor’s DC bias effect). An antiringing circuit damps any oscillation at the switch node when the inductor current falls to zero.

### Power Adjust Feature

The LTC3525 incorporates a feature that maximizes efficiency at light load while providing increased power capability at heavy load by adjusting the peak and valley of the inductor current as a function of load. Lowering the peak inductor current to 150mA at light load optimizes efficiency by reducing conduction losses in the internal MOSFET switches. As the load increases, the peak inductor current is automatically increased to a maximum of 400mA. At intermediate loads, the peak inductor current may vary from 150mA to 400mA. Figure 1 shows an example of how the inductor current changes as the load increases. Please note that output capacitor values greater than 47µF will result in higher peak currents than necessary at light load. This will lower the light load efficiency.

The valley of the inductor current is automatically adjusted as well, to maintain a relatively constant inductor ripple current. This keeps the switching frequency relatively constant.

The maximum average load current that can be supported is given by:

$$I_{O(MAX)} = \frac{0.3 \cdot V_{IN} \cdot \eta}{V_O} \text{Amps}$$

Where  $\eta$  is the efficiency (see Typical Performance Characteristics).

The “burst” frequency (how often the LTC3525 delivers a burst of current pulses to the load) is determined by the internal hysteresis (output voltage ripple), the load current and the amount of output capacitance. All Burst Mode operation or hysteretic converters will enter the audible frequency range when the load is light enough. However, due to the low peak inductor current at light load, circuits using the LTC3525 do not typically generate any audible noise.

## OPERATION

### Component Selection

Inductor values between  $4.7\mu\text{H}$  and  $15\mu\text{H}$  are recommended. In most applications  $10\mu\text{H}$  will yield the best compromise between size and efficiency. The inductor should be a low-loss ferrite design and must be rated for peak currents of at least 400mA without saturating. Inductors with lower DC resistance will improve efficiency. Note that the inductor value does not have a significant effect on ripple current, so while lower values will increase the operating frequency, they do not reduce output voltage ripple.

Some recommended inductor examples are Murata LQH32C and Coilcraft LPO4812, LPO3310, DO3314, DS1608 and MSS4020.

A ceramic input bypass capacitor should be located as close as possible to the  $V_{\text{IN}}$  and GND pins of the IC. A minimum value of  $1\mu\text{F}$  is recommended. If the battery is more than a few inches away, a bulk tantalum decoupling cap of at least  $10\mu\text{F}$  is recommended on  $V_{\text{IN}}$ .

The output capacitor should also be a ceramic, located close to the  $V_{\text{OUT}}$  and GND pins. A minimum value of  $10\mu\text{F}$  is recommended. Increasing the value of the output capacitor to  $22\mu\text{F}$  will result in lower output ripple. Higher capacitor values will only offer a small reduction in output ripple, while reducing light load efficiency by causing the peak inductor current to increase above its minimum value of 150mA. The input and output capacitors should be X5R or X7R types, not Y5V.

**Table 1. Inductor Vendor Information**

SUPPLIER	PHONE	FAX	WEBSITE
Murata	USA: (814) 237-1431	USA: (814) 238-0490	www.murata.com
Coilcraft	(847) 639-6400	(847) 639-1469	www.coilcraft.com
Sumida	USA: (847) 956-0666	USA: (847) 956-0702	www.sumida.com

**Table 2. Capacitor Vendor Information**

SUPPLIER	PHONE	FAX	WEBSITE
Murata	USA: (814) 237-1431	USA: (814) 238-0490	www.murata.com
Taiyo Yuden	(408) 573-4150	(408) 573-4159	www.t-yuden.com
TDK	(847) 803-6100	(847) 803-6296	www.component.tdk.com
AVX	(803) 448-9411	(803) 448-1943	www.avxcorp.com

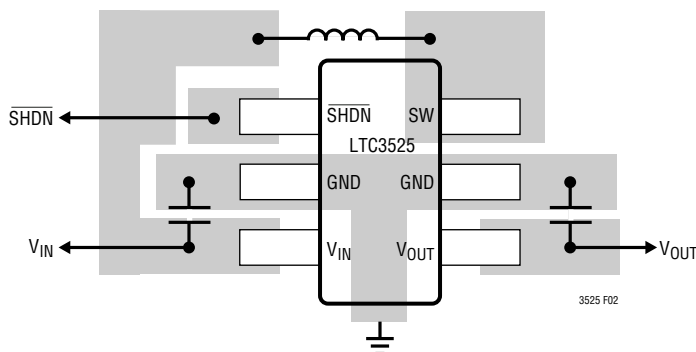

**Figure 2. Recommended Component Placement**

## TYPICAL APPLICATIONS

### Single Cell to 3V Converter Using 1mm High Monolithic Inductor

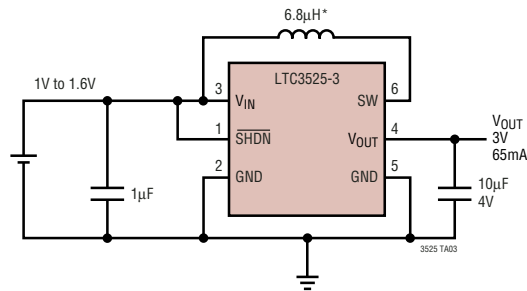

\*FDK MIP3226D6R8M

### Single Alkaline or NiMH to 3.3V Converter with 1mm Profile

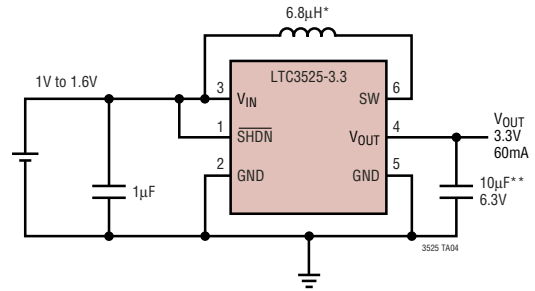

\*COILCRAFT LPO3310-682MXD  
\*\*MURATA GRM219R60J106KE191D

### 2-Alkaline or NiMH to 3.3V

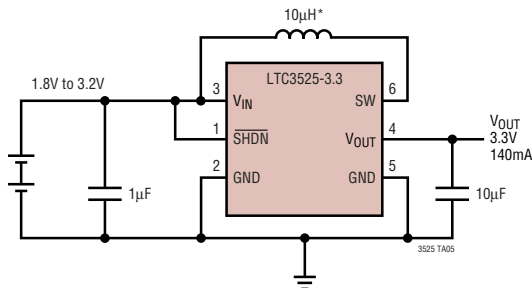

\*MURATA LQH32CN1002K53

### Li-Ion to 5V

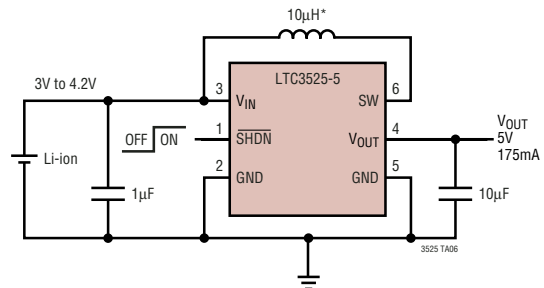

\*COILCRAFT MSS4020-103MXD

## PACKAGE DESCRIPTION

### SC6 Package 6-Lead Plastic SC70 (Reference LTC DWG # 05-08-1638)

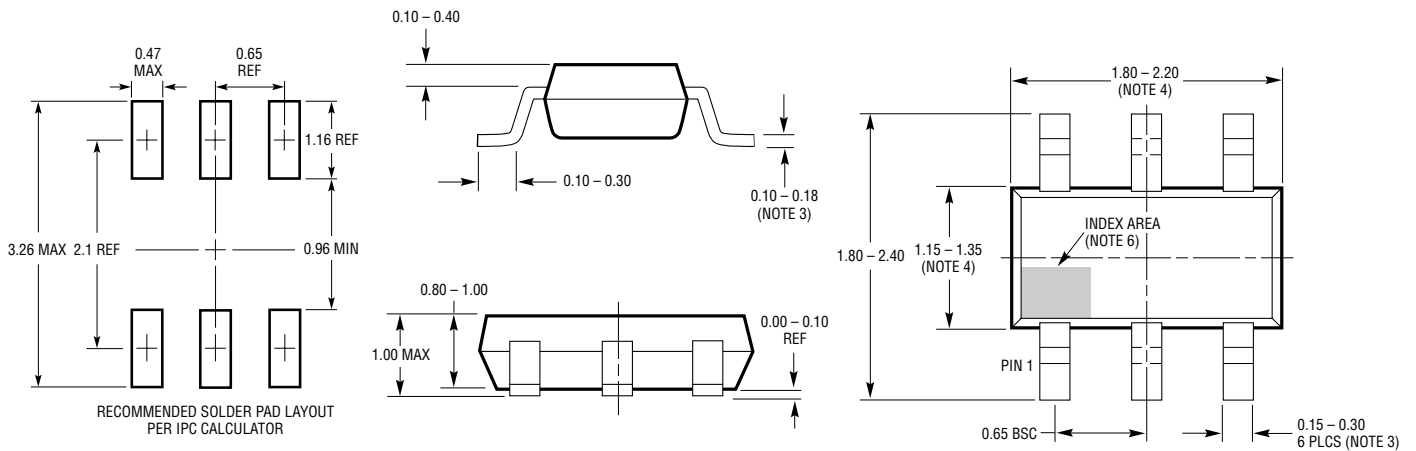

- NOTE:
1. DIMENSIONS ARE IN MILLIMETERS
  2. DRAWING NOT TO SCALE
  3. DIMENSIONS ARE INCLUSIVE OF PLATING
  4. DIMENSIONS ARE EXCLUSIVE OF MOLD FLASH AND METAL BURR
  5. MOLD FLASH SHALL NOT EXCEED 0.254mm
  6. DETAILS OF THE PIN 1 IDENTIFIER ARE OPTIONAL, BUT MUST BE LOCATED WITHIN THE INDEX AREA
  7. EIAJ PACKAGE REFERENCE IS EIAJ SC-70

3525fa

## TYPICAL APPLICATION

3.3V TO 5V Converter with 1.4mm Profile

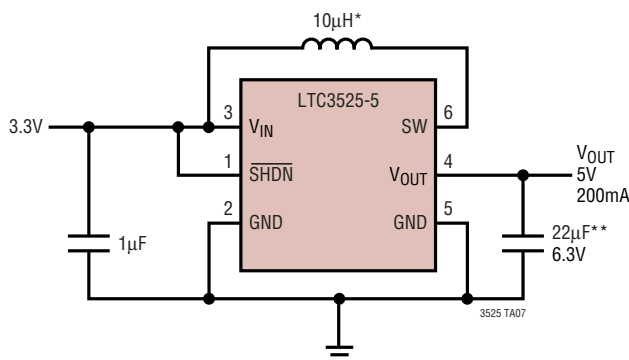

\*COILCRAFT D03314-103MXD  
\*\*MURATA GRM21BR60J226ME39L

## RELATED PARTS

PART NUMBER	DESCRIPTION	COMMENTS
LT <sup>®</sup> 1615/LT1615-1	300mA/80mA ( $I_{SW}$ ), High Efficiency Step-Up DC/DC Converter	$V_{IN}$ : 1V to 15V, $V_{OUT(MAX)}$ = 34V, $I_Q$ = 20µA, $I_{SD}$ < 1µA, ThinSOT <sup>™</sup> Package
LTC1751-3.3/ LTC1751-5	100mA, 800kHz, Micropower, Regulated Charge Pump DC/DC Converters	$V_{IN}$ : 2.5V to 5.5V, $V_{OUT(MAX)}$ = 3.3V/5V, $I_Q$ = 20µA, $I_{SD}$ < 1µA, MS8 Package
LT1930/LTC1930A	1A ( $I_{SW}$ ), 1.2MHz/2MHz, High Efficiency Step-Up DC/DC Converter	High Efficiency, $V_{IN}$ : 2.6V to 16V, $V_{OUT(MAX)}$ = 34V, $I_Q$ = 4.2mA/5.5mA, $I_{SD}$ < 1µA, ThinSOT Package
LTC3200-5	100mA, 2MHz, Regulated 5V Charge Pump	$V_{IN}$ : 2.7V to 4.5V, $V_{OUT(MAX)}$ = 5V, $I_Q$ = 2mA, $I_{SD}$ < 1µA, ThinSOT Package
LTC3400/LTC3400B	600mA ( $I_{SW}$ ), 1.2MHz, Synchronous Step-Up DC/DC Converter	92% Efficiency, $V_{IN}$ : 0.5V to 5V, $V_{OUT(MAX)}$ = 5V, $I_Q$ = 19µA/300µA, $I_{SD}$ < 1µA, ThinSOT Package
LTC3401	1A ( $I_{SW}$ ), 3MHz, Synchronous Step-Up DC/DC Converter	97% Efficiency, $V_{IN}$ : 0.5V to 5V, $V_{OUT(MAX)}$ = 5.5V, $I_Q$ = 38µA, $I_{SD}$ < 1µA, MS Package
LTC3402	2A ( $I_{SW}$ ), 3MHz, Synchronous Step-Up DC/DC Converter	97% Efficiency, $V_{IN}$ : 0.5V to 5V, $V_{OUT(MAX)}$ = 5.5V, $I_Q$ = 38µA, $I_{SD}$ < 1µA, MS Package
LTC3421	3A ( $I_{SW}$ ), 3MHz, Synchronous Step-Up DC/DC Converter with Output Disconnect	95% Efficiency, $V_{IN}$ : 0.5V to 4.5V, $V_{OUT(MAX)}$ = 5.25V, $I_Q$ = 12µA, $I_{SD}$ < 1µA, QFN-24 Package
LTC3425	5A ( $I_{SW}$ ), 8MHz, 4-Phase Synchronous Step-Up DC/DC Converter with Output Disconnect	95% Efficiency, $V_{IN}$ : 0.5V to 4.5V, $V_{OUT(MAX)}$ = 5.25V, $I_Q$ = 12µA, $I_{SD}$ < 1µA, QFN-32 Package
LTC3429/LTC3429B	600mA, 500kHz Single/Dual Cell Micropower Synchronous Boost Converter with Output Disconnect	95% Efficiency, $V_{IN}$ : 1V to 4.5V, $V_{OUT(MAX)}$ = 5V, $I_Q$ = 20µA, $I_{SD}$ < 1µA, SC70 Package
LTC3458	1.4A ( $I_{SW}$ ), 1.5MHz, Synchronous Step-Up DC/DC Converter with Output Disconnect	$V_{IN}$ : 1.5V to 6V, $V_{OUT(MAX)}$ = 7.5V, $I_{SD}$ < 1µA, 3mm × 4mm DFN Package
LTC3458L	1.7A ( $I_{SW}$ ), 1.5MHz, Synchronous Step-Up DC/DC Converter with Output Disconnect	$V_{IN}$ : 1.5V to 6V, $V_{OUT(MAX)}$ = 6V, $I_{SD}$ < 1µA, 3mm × 4mm DFN Package
LTC3459	60mA, 10V Micro Power Synchronous Boost Converter	95% Efficiency, $V_{IN}$ : 1.5V to 6V, $V_{OUT(MAX)}$ = 10V, $I_Q$ = 10µA, $I_{SD}$ < 1µA, ThinSOT Package
LT3464	85mA ( $I_{SW}$ ), High Efficiency Step-Up DC/DC Converter with Integrated Schottky and PNP Disconnect	$V_{IN}$ : 2.3V to 10V, $V_{OUT(MAX)}$ = 34V, $I_Q$ = 25µA, $I_{SD}$ < 1µA, ThinSOT Package

ThinSOT is a trademark of Linear Technology Corporation.