

# 25-05123



This part is readily available and works in this application There is a Vishay part that is Si7236DP that would work better but is hard to buy

OCTOBER 2001

FDS6898A

## FDS6898A

### Dual N-Channel Logic Level PWM Optimized PowerTrench<sup>®</sup> MOSFET

#### General Description

These N-Channel Logic Level MOSFETs are produced using Fairchild Semiconductor's advanced PowerTrench process that has been especially tailored to minimize the on-state resistance and yet maintain superior switching performance.

These devices are well suited for low voltage and battery powered applications where low in-line power loss and fast switching are required.

#### Features

- 9.4 A, 20 V  $R_{DS(ON)} = 14\text{ m}\Omega @ V_{GS} = 4.5\text{ V}$   
 $R_{DS(ON)} = 18\text{ m}\Omega @ V_{GS} = 2.5\text{ V}$
- Low gate charge (16 nC typical)
- High performance trench technology for extremely low  $R_{DS(ON)}$
- High power and current handling capability

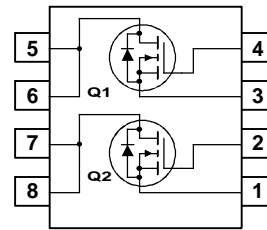
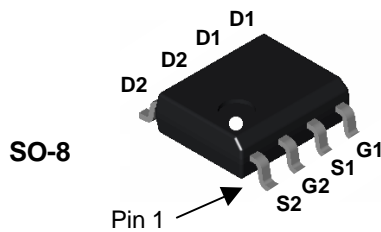

#### Absolute Maximum Ratings T<sub>A</sub>=25°C unless otherwise noted

Symbol	Parameter	Ratings	Units
V <sub>DSS</sub>	Drain-Source Voltage	20	V
V <sub>GSS</sub>	Gate-Source Voltage	± 12	V
I <sub>D</sub>	Drain Current – Continuous (Note 1a)	9.4	A
	– Pulsed	38	
P <sub>D</sub>	Power Dissipation for Dual Operation	2	W
	Power Dissipation for Single Operation (Note 1a)	1.6	
	(Note 1b)	1	
	(Note 1c)	0.9	
T <sub>J</sub> , T <sub>STG</sub>	Operating and Storage Junction Temperature Range	–55 to +150	°C

#### Thermal Characteristics

R <sub>θJA</sub>	Thermal Resistance, Junction-to-Ambient (Note 1a)	78	°C/W
R <sub>θJC</sub>	Thermal Resistance, Junction-to-Case (Note 1)	40	°C/W

#### Package Marking and Ordering Information

Device Marking	Device	Reel Size	Tape width	Quantity
FDS6898A	FDS6898A	13"	12mm	2500 units

## Electrical Characteristics

$T_A = 25^\circ\text{C}$  unless otherwise noted

Symbol	Parameter	Test Conditions	Min	Typ	Max	Units
--------	-----------	-----------------	-----	-----	-----	-------

### Off Characteristics

$BV_{DSS}$	Drain–Source Breakdown Voltage	$V_{GS} = 0\text{ V}, I_D = 250\ \mu\text{A}$	20			V
$\frac{\Delta BV_{DSS}}{\Delta T_J}$	Breakdown Voltage Temperature Coefficient	$I_D = 250\ \mu\text{A}$ , Referenced to $25^\circ\text{C}$		21		mV/ $^\circ\text{C}$
$I_{DSS}$	Zero Gate Voltage Drain Current	$V_{DS} = 16\text{ V}, V_{GS} = 0\text{ V}$			1	$\mu\text{A}$
$I_{GSSF}$	Gate–Body Leakage, Forward	$V_{GS} = 12\text{ V}, V_{DS} = 0\text{ V}$			100	nA
$I_{GSSR}$	Gate–Body Leakage, Reverse	$V_{GS} = -12\text{ V}, V_{DS} = 0\text{ V}$			-100	nA

### On Characteristics (Note 2)

$V_{GS(th)}$	Gate Threshold Voltage	$V_{DS} = V_{GS}, I_D = 250\ \mu\text{A}$	0.5	1	1.5	V
$\frac{\Delta V_{GS(th)}}{\Delta T_J}$	Gate Threshold Voltage Temperature Coefficient	$I_D = 250\ \mu\text{A}$ , Referenced to $25^\circ\text{C}$		-3.5		mV/ $^\circ\text{C}$
$R_{DS(on)}$	Static Drain–Source On–Resistance	$V_{GS} = 4.5\text{ V}, I_D = 9.4\text{ A}$ $V_{GS} = 2.5\text{ V}, I_D = 8.3\text{ A}$ $V_{GS} = 4.5\text{ V}, I_D = 9.4\text{ A}, T_J = 125^\circ\text{C}$		10 13 14	14 18 21	m $\Omega$
$I_{D(on)}$	On–State Drain Current	$V_{GS} = 4.5\text{ V}, V_{DS} = 5\text{ V}$	19			A
$g_{FS}$	Forward Transconductance	$V_{DS} = 5\text{ V}, I_D = 9.4\text{ A}$		47		S

### Dynamic Characteristics

$C_{iss}$	Input Capacitance	$V_{DS} = 10\text{ V}, V_{GS} = 0\text{ V},$ $f = 1.0\text{ MHz}$		1821		pF
$C_{oss}$	Output Capacitance			440		pF
$C_{rss}$	Reverse Transfer Capacitance			208		pF

### Switching Characteristics (Note 2)

$t_{d(on)}$	Turn–On Delay Time	$V_{DD} = 10\text{ V}, I_D = 1\text{ A},$ $V_{GS} = 4.5\text{ V}, R_{GEN} = 6\ \Omega$		10	20	ns
$t_r$	Turn–On Rise Time			15	27	ns
$t_{d(off)}$	Turn–Off Delay Time			34	55	ns
$t_f$	Turn–Off Fall Time			16	29	ns
$Q_g$	Total Gate Charge		$V_{DS} = 10\text{ V}, I_D = 9.4\text{ A},$ $V_{GS} = 4.5\text{ V}$		16	23
$Q_{gs}$	Gate–Source Charge			3		nC
$Q_{gd}$	Gate–Drain Charge			4		nC

### Drain–Source Diode Characteristics and Maximum Ratings

$I_S$	Maximum Continuous Drain–Source Diode Forward Current			1.3		A
$V_{SD}$	Drain–Source Diode Forward Voltage	$V_{GS} = 0\text{ V}, I_S = 1.3\text{ A}$ (Note 2)		0.7	1.2	V

#### Notes:

- $R_{\theta JA}$  is the sum of the junction-to-case and case-to-ambient thermal resistance where the case thermal reference is defined as the solder mounting surface of the drain pins.  $R_{\theta JC}$  is guaranteed by design while  $R_{\theta CA}$  is determined by the user's board design.

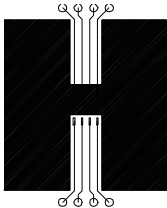

a)  $78^\circ\text{C/W}$  when mounted on a  $0.5\text{ in}^2$  pad of 2 oz copper

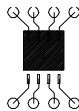

b)  $125^\circ\text{C/W}$  when mounted on a  $0.02\text{ in}^2$  pad of 2 oz copper

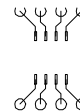

c)  $135^\circ\text{C/W}$  when mounted on a minimum mounting pad.

Scale 1 : 1 on letter size paper

2. Pulse Test: Pulse Width <  $300\ \mu\text{s}$ , Duty Cycle < 2.0%

3. The diode connected between the gate and source serves only as protection against ESD. No gate overvoltage rating is implied

## Typical Characteristics

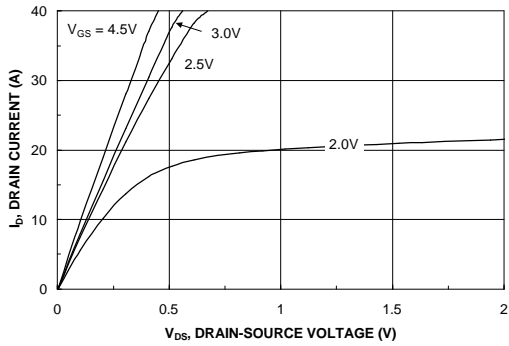

Figure 1. On-Region Characteristics.

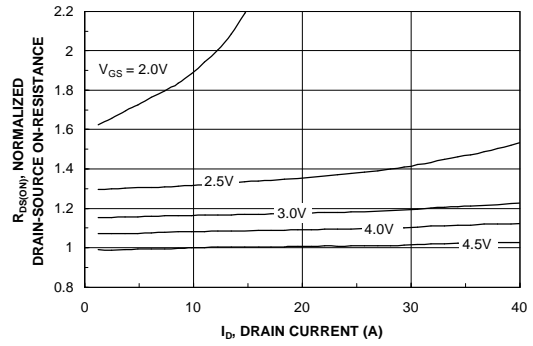

Figure 2. On-Resistance Variation with Drain Current and Gate Voltage.

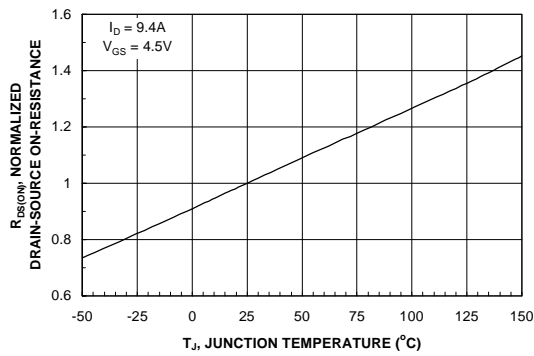

Figure 3. On-Resistance Variation with Temperature.

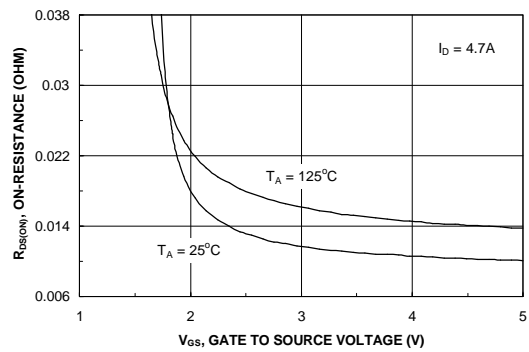

Figure 4. On-Resistance Variation with Gate-to-Source Voltage.

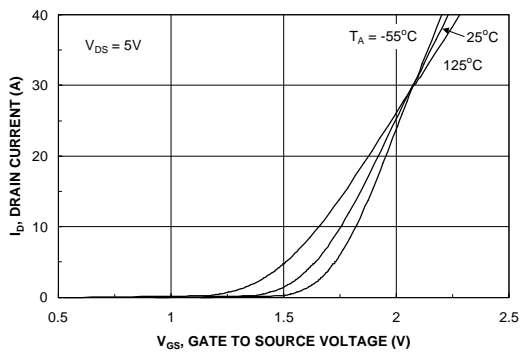

Figure 5. Transfer Characteristics.

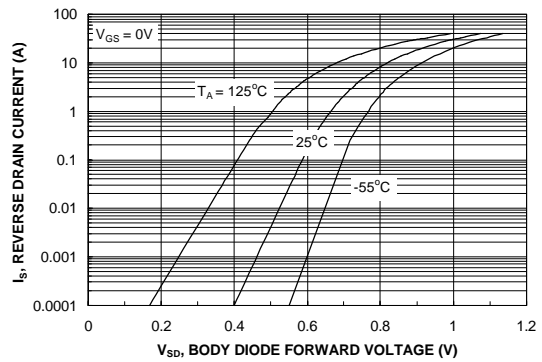

Figure 6. Body Diode Forward Voltage Variation with Source Current and Temperature.

# Typical Characteristics

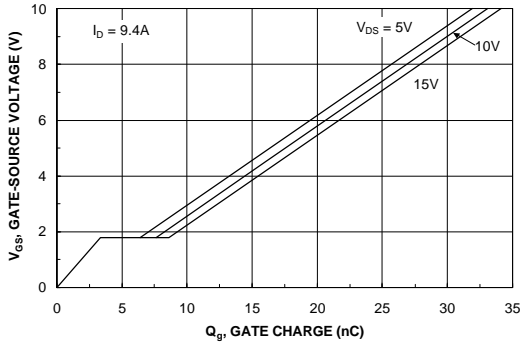

Figure 7. Gate Charge Characteristics.

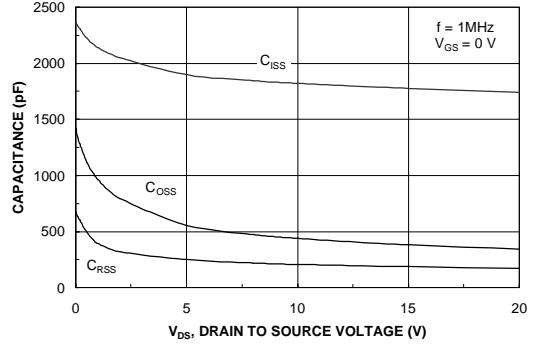

Figure 8. Capacitance Characteristics.

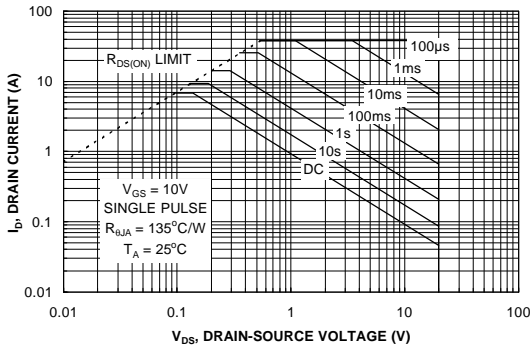

Figure 9. Maximum Safe Operating Area.

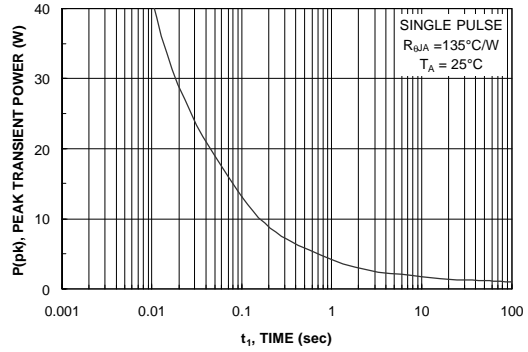

Figure 10. Single Pulse Maximum Power Dissipation.

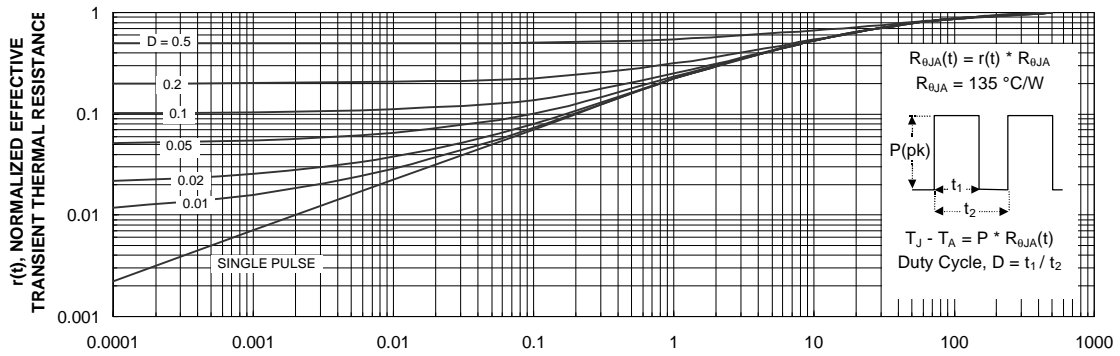

Figure 11. Transient Thermal Response Curve.

Thermal characterization performed using the conditions described in Note 1c. Transient thermal response will change depending on the circuit board design.

## TRADEMARKS

The following are registered and unregistered trademarks Fairchild Semiconductor owns or is authorized to use and is not intended to be an exhaustive list of all such trademarks.

ACE <sub>x</sub> <sup>TM</sup>	FAST <sup>®</sup>	OPTOLOGIC <sup>TM</sup>	SMART START <sup>TM</sup>	VCX <sup>TM</sup>
Bottomless <sup>TM</sup>	FAST <sub>r</sub> <sup>TM</sup>	OPTOPLANAR <sup>TM</sup>	STAR*POWER <sup>TM</sup>	
CoolFET <sup>TM</sup>	FRFET <sup>TM</sup>	PACMAN <sup>TM</sup>	Stealth <sup>TM</sup>	
CROSSVOLT <sup>TM</sup>	GlobalOptoisolator <sup>TM</sup>	POPT <sup>TM</sup>	SuperSOT <sup>TM</sup> -3	
DenseTrench <sup>TM</sup>	GTO <sup>TM</sup>	Power247 <sup>TM</sup>	SuperSOT <sup>TM</sup> -6	
DOMET <sup>TM</sup>	HiSeC <sup>TM</sup>	PowerTrench <sup>®</sup>	SuperSOT <sup>TM</sup> -8	
EcoSPARK <sup>TM</sup>	ISOPLANAR <sup>TM</sup>	QFET <sup>TM</sup>	SyncFET <sup>TM</sup>	
E <sup>2</sup> CMOS <sup>TM</sup>	LittleFET <sup>TM</sup>	QST <sup>TM</sup>	TinyLogic <sup>TM</sup>	
EnSigna <sup>TM</sup>	MicroFET <sup>TM</sup>	QT Optoelectronics <sup>TM</sup>	TruTranslation <sup>TM</sup>	
FACT <sup>TM</sup>	MicroPak <sup>TM</sup>	Quiet Series <sup>TM</sup>	UHC <sup>TM</sup>	
FACT Quiet Series <sup>TM</sup>	MICROWIRE <sup>TM</sup>	SILENT SWITCHER <sup>®</sup>	UltraFET <sup>®</sup>	

STAR\*POWER is used under license

## DISCLAIMER

FAIRCHILD SEMICONDUCTOR RESERVES THE RIGHT TO MAKE CHANGES WITHOUT FURTHER NOTICE TO ANY PRODUCTS HEREIN TO IMPROVE RELIABILITY, FUNCTION OR DESIGN. FAIRCHILD DOES NOT ASSUME ANY LIABILITY ARISING OUT OF THE APPLICATION OR USE OF ANY PRODUCT OR CIRCUIT DESCRIBED HEREIN; NEITHER DOES IT CONVEY ANY LICENSE UNDER ITS PATENT RIGHTS, NOR THE RIGHTS OF OTHERS.

## LIFE SUPPORT POLICY

FAIRCHILD'S PRODUCTS ARE NOT AUTHORIZED FOR USE AS CRITICAL COMPONENTS IN LIFE SUPPORT DEVICES OR SYSTEMS WITHOUT THE EXPRESS WRITTEN APPROVAL OF FAIRCHILD SEMICONDUCTOR CORPORATION.

As used herein:

1. Life support devices or systems are devices or systems which, (a) are intended for surgical implant into the body, or (b) support or sustain life, or (c) whose failure to perform when properly used in accordance with instructions for use provided in the labeling, can be reasonably expected to result in significant injury to the user.
2. A critical component is any component of a life support device or system whose failure to perform can be reasonably expected to cause the failure of the life support device or system, or to affect its safety or effectiveness.

## PRODUCT STATUS DEFINITIONS

### Definition of Terms

Datasheet Identification	Product Status	Definition
Advance Information	Formative or In Design	This datasheet contains the design specifications for product development. Specifications may change in any manner without notice.
Preliminary	First Production	This datasheet contains preliminary data, and supplementary data will be published at a later date. Fairchild Semiconductor reserves the right to make changes at any time without notice in order to improve design.
No Identification Needed	Full Production	This datasheet contains final specifications. Fairchild Semiconductor reserves the right to make changes at any time without notice in order to improve design.
Obsolete	Not In Production	This datasheet contains specifications on a product that has been discontinued by Fairchild semiconductor. The datasheet is printed for reference information only.

REVISIONS			
LTR	DESCRIPTION	DATE	BY/APP'D
12	CHANGED LEADSPREAD, TERMINAL WIDTH, AND FOOT LENGTH, REMOVED REFERENCE TO LEAD FINISH.	27 JULY 07	L.HUEBENER
13	ADDED OPTION "A" AND "B" VIEW	19 SEPT 07	H.ALLEN

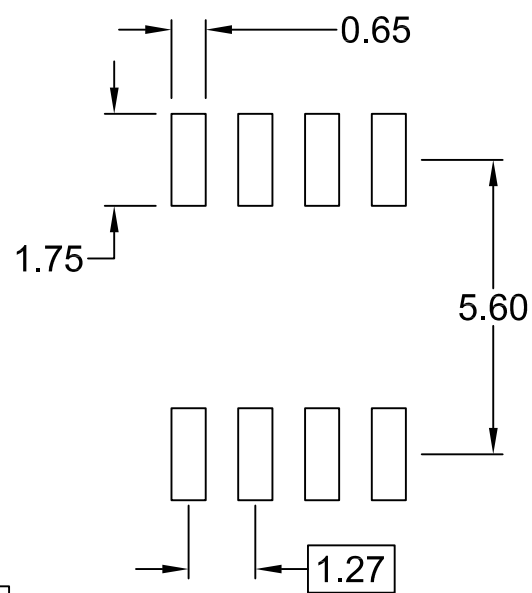
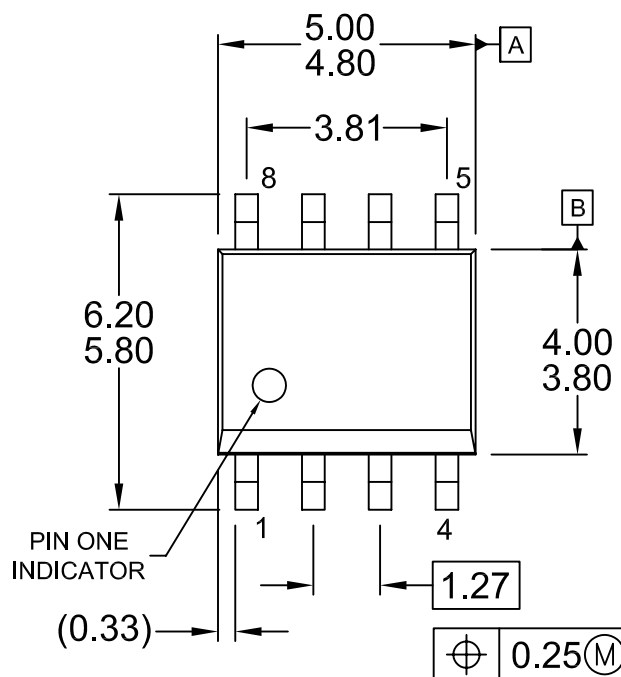

⊕	0.25	Ⓜ	C	B	A
---	------	---	---	---	---

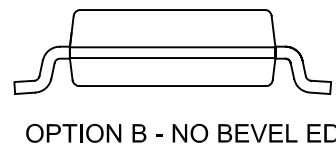
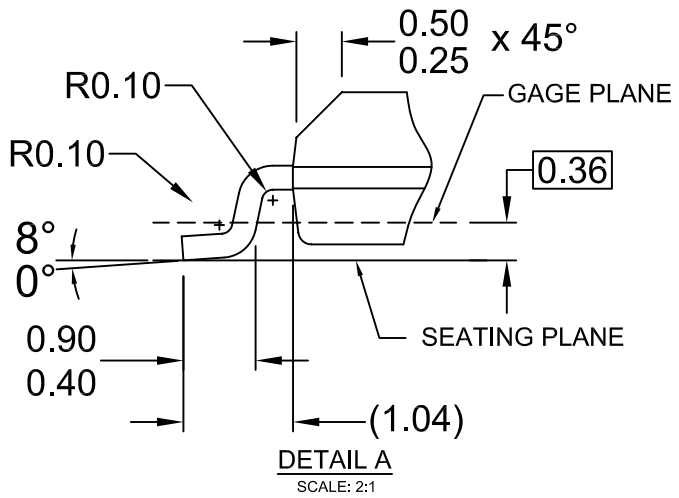
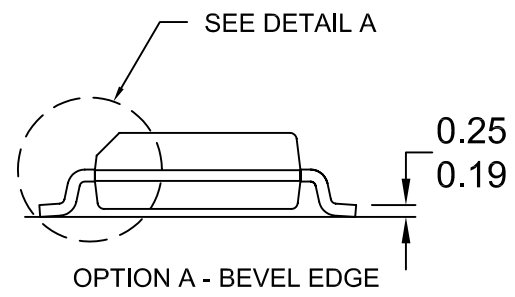
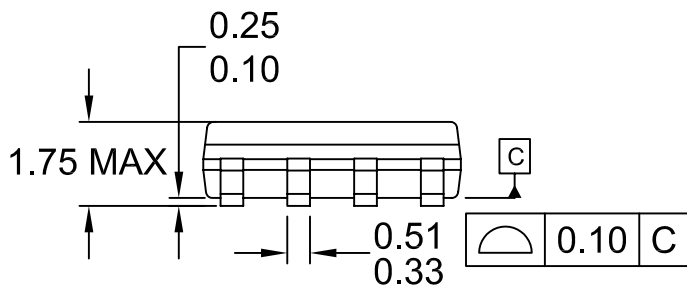

NOTES: UNLESS OTHERWISE SPECIFIED

- A) THIS PACKAGE CONFORMS TO JEDEC MS-012, VARIATION AA, ISSUE C,
- B) ALL DIMENSIONS ARE IN MILLIMETERS.
- C) DIMENSIONS DO NOT INCLUDE MOLD FLASH OR BURRS.
- D) LANDPATTERN STANDARD: SOIC127P600X175-8M.
- E) DRAWING FILENAME: M08AREV13

APPROVALS		DATE			
DRAWN	H.ALLEN	19 SEPT 07			
DFTG. CHK.	SSI. CHOI	20 SEPT 07			
ENGR. CHK.					
			8LD, SOIC, JEDEC MS-012, 0.150" NARROW BODY		
PROJECTION		SCALE	SIZE	DRAWING NUMBER	REV
		N/A	C	MKT-M08A	13
DO NOT SCALE DRAWING			SHEET	1 of 1	